



#N2201 Installation Instructions 2016-2017 Nissan Titan XD 4wd 2" Strut Spacer Lift

Read and understand all instructions and warnings prior to installation of product and operation of vehicle.

Zone Offroad Products recommends this system be installed by a professional technician. In addition to these instructions, professional knowledge of disassembly/ reassembly procedures and post installation checks must be known. Minimum tool requirements include the following: Assorted metric and standard wrenches, hammer, hydraulic floor jack and a set of jack stands. See the "Special Tools Required" section for additional tools needed to complete this installation properly and safely.

» PRODUCT SAFETY WARNING

Certain Zone Suspension Products are intended to improve off-road performance. Modifying your vehicle for off-road use may result in the vehicle handling differently than a factory equipped vehicle. Extreme care must be used to prevent loss of control or vehicle rollover. Failure to drive your modified vehicle safely may result in serious injury or death. Zone Offroad Products does not recommend the combined use of suspension lifts, body lifts, or other lifting devices.

You should never operate your modified vehicle under the influence of alcohol or drugs. Always drive your modified vehicle at reduced speeds to ensure your ability to control your vehicle under all driving conditions. Always wear your seat belt.

» TECHNICAL SUPPORT

www.zoneoffroad.com may have additional information about this product including the latest instructions, videos, photos, etc.

Send an e-mail to tech-zone@sporttruckusainc.com detailing your issue for a quick response.

888.998.ZONE Call to speak directly with Zone tech support.

» PRE-INSTALLATION NOTES

1. Special literature required: OE Service Manual for model/year of vehicle. Refer to manual for proper disassembly/reassembly procedures of OE and related components.
2. Adhere to recommendations when replacement fasteners, retainers and keepers are called out in the OE manual.
3. Larger rim and tire combinations may increase leverage on suspension, steering, and related components. When selecting combinations larger than OE, consider the additional stress you could be inducing on the OE and related components.
4. Post suspension system vehicles may experience drive line vibrations. Angles may require tuning, slider on shaft may require replacement, shafts may need to be lengthened or trued, and U-joints may need to be replaced.
5. Secure and properly block vehicle prior to installation of Zone Offroad Products. Always wear safety glasses when using power tools.
6. If installation is to be performed without a hoist, Zone Offroad Products recommends rear alterations first.
7. Due to payload options and initial ride height variances, the amount of lift is a base figure. Final ride height dimensions may vary in accordance to original vehicle attitude. Always measure the attitude prior to beginning installation.
8. This kit will ONLY fit a Nissan Titan XD (will not fit the regular Titan)

Difficulty Level

easy 1 2 3 4 5 difficult

Estimated installation: 1-2 hours

Special Tools Required

None

Tire/Wheel Fitment

Tire:

27560 R20

285/60 R20 Minor Trimming Required

Wheel:

Stock

Kit Contents

N2201 Front Box Kit

Qty	Part
2	Front Strut Spacer
1	Bolt Pack - Front Strut Spacers
1	Steering Centerlink
2	Bump Stop Spacers
2	PEM Studs
2	Sway Bar Spacers
1	Bolt Pack - Sway Bar Spacers

N2209 Rear Box Kit

Qty	Part
2	2" Rear Lift Block
4	9/16" x 3-1/8" U-Bolts
8	9/16" High Nuts
8	9/16" SAE Flat Washers
2	Cable Ties
2	Sway Bar Links
4	Sway Bar Link Bushings
4	Sway Bar Link Sleeves
1	Bolt Pack - Rear Sway Bar Links

INSTALLATION INSTRUCTIONS

»» FRONT INSTALLATION

1. Park the vehicle on a clean, flat surface and block the rear wheels for safety.
2. Raise the front of the vehicle and support with jack stands under the frame rails, behind the suspension.
3. Remove the front wheels.
4. Disconnect the sway bar links from the lower control arms **Figure 1**. Save hardware.

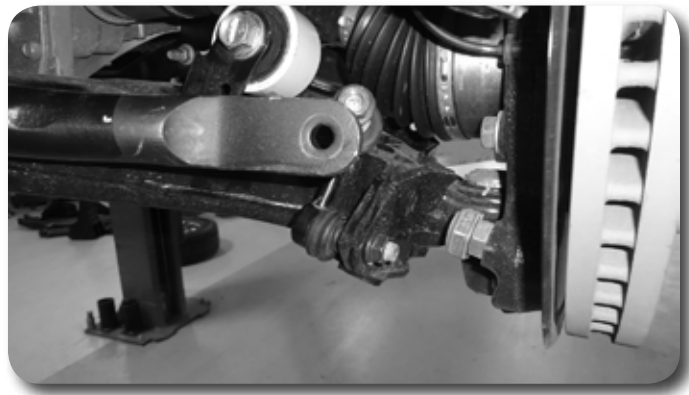

Figure 1

5. Locate the lower alignment cam bolts. **Figure 2**. Mark the position of the lower control arm cam washers. These marks will be used for reference during assembly. Loosen the bolts (2 per arm - 4 total). This will allow the lower control arm to swing down and out of the way when the strut is disconnected.



Figure 2

6. Remove the nut from the steering tie rod end. **Figure 3** Thread the nut back on a couple of turns by hand. Strike the knuckle near the tie rod end to dislodge the rod end taper from the knuckle. Remove the nut and the tie rod end from the knuckle. Save nut.



Figure 3

7. Support the lower control arm with a hydraulic jack and remove the nut from the upper ball joint. Thread the nut back on a couple of turns by hand. Strike the knuckle near the upper ball joint to dislodge the rod end taper from the knuckle **Figure 4**. Remove the nut and allow the knuckle to swing rearward out of the way. Save the ball joint nut.

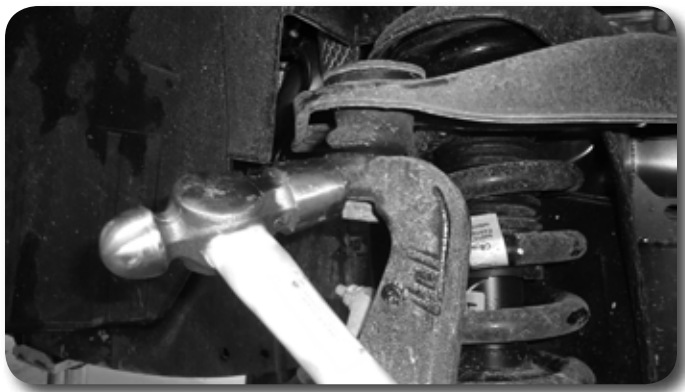

Figure 4

8. Remove the lower strut mount bolt at the lower control arm. **Figure 5** Swing the lower control arm down and out of the way. Save hardware. Be sure not to over-extend / bind and ABS, brake lines, etc.

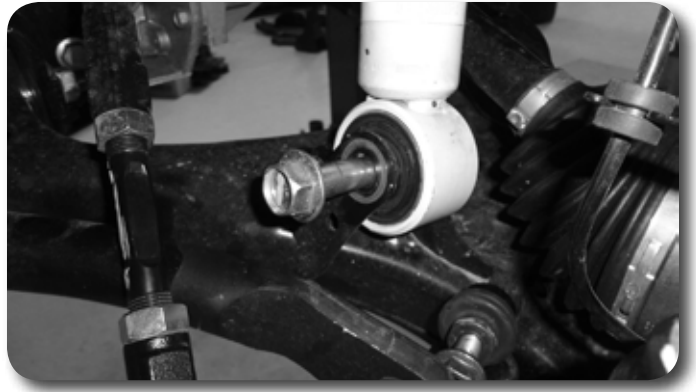

Figure 5

9. Locate the 3 upper strut mount nuts. **Figure 6** Remove the nuts and remove the strut from the vehicle. Do not remove the center strut rod nut. It is under extreme pressure. Save nuts.



Figure 6

10. Remove the nut from the steering tie rod end at the steering centerlink. **Figure 7** Thread the nut back on a couple of turns by hand. Strike the centerlink near the tie rod end to dislodge the tie rod end taper from the centerlink. Remove the nut and the tie rod end from the vehicle. Save nut. Mark each tie rod as either driver / passenger.



Figure 7

11. Push / pull the steering center towards the driver / passenger side in order to gain access from underneath to remove the nuts for the pitman arm and idler arm. Remove the nuts and thread the nut back on a couple turns by hand. Strike the centerlink near the pitman / idler arm to dislodge the taper from the centerlink. Remove and save the hardware.
12. Once both tapers are released, remove the centerlink from the vehicle **Figure 8**.

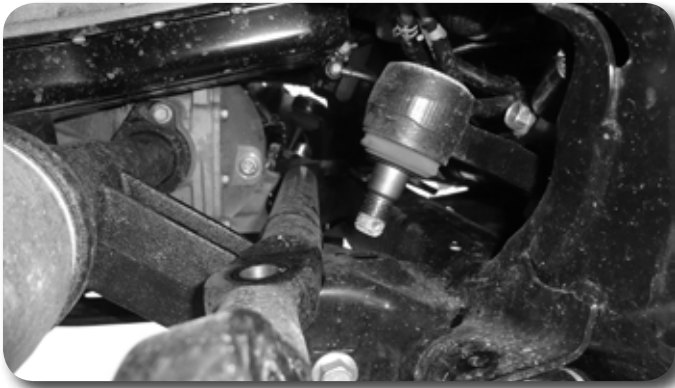

Figure 8

13. Install the new steering centerlink to improve toe change through wheel travel. The centerlink can only be installed one way. The idler arm location has a smaller taper and will have a clearance cutout for the nut to sit into, similar to the factory steering centerlink.
14. Install the centerlink to the idler arm and pitman arm with the factory nuts **Figure 9**. Tighten to factory specifications.

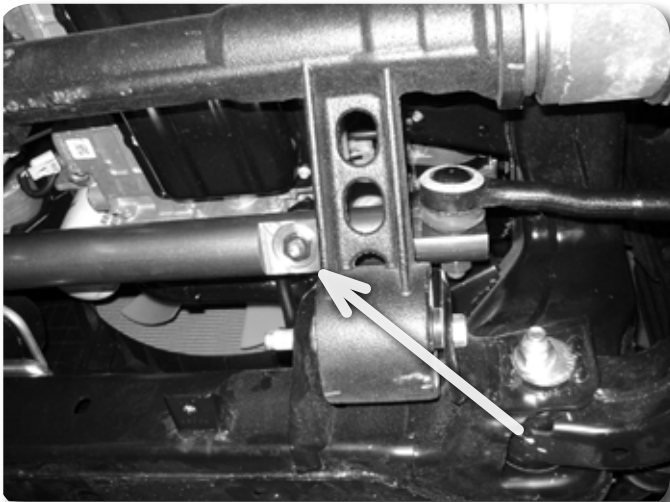

Figure 9

15. Install inner tie rod ends with factory nuts **Figure 10**. Tighten to factory specifications.



Figure 10

Step 17 Note

To make the brackets side specific install the PEM stud the opposite direction through the bracket for each side.

16. Remove the factory bump stops from the lower control arm. Retain nut.
17. Press the PEM stud into brackets so that each bracket will become side specific. Use a hammer and socket to seat the stud into bracket [Figure 11](#).



Figure 11

18. Place spacer onto the bump stop as shown [Figure 12](#). The stud will be used to eliminate any chance of rotation by using the existing hole in the factory arm.



Figure 12

19. Reinstall the bump stop with spacer onto the lower control arm with factory nut **Figure 13**. Tighten to factory specifications.



Figure 13

20. Remove the factory hardware attaching the sway bar to the frame. Hardware will not be reused.
21. Place the sway bar drop spacers between the sway bar and frame **Figure 14**. Attach with new 12mm x 50mm hardware. Tighten to 55 ft-lbs.

Step 21 Note

Hardware for the sway bar drop brackets is located in Bolt Pack 981

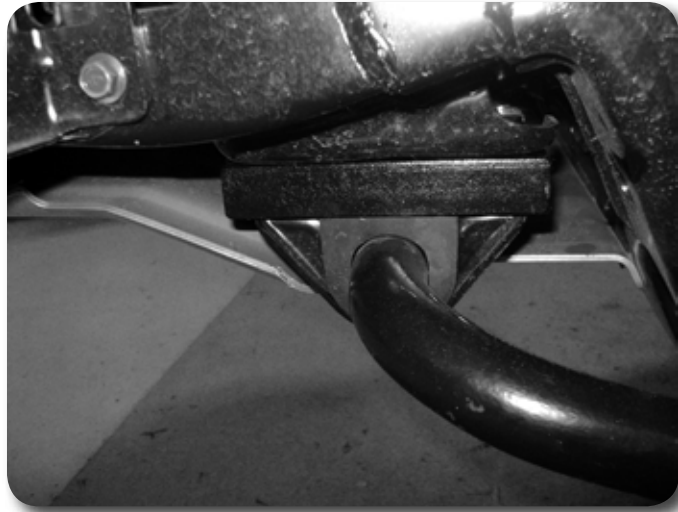

Figure 14

22. Install upper control arms at this time, follow instructions provided with the upper control arms.
23. Locate one of the supplied strut spacers and install on the factory upper strut mount studs. Fasten with the original nuts and tighten securely (45 ft-lbs).
Figure 15

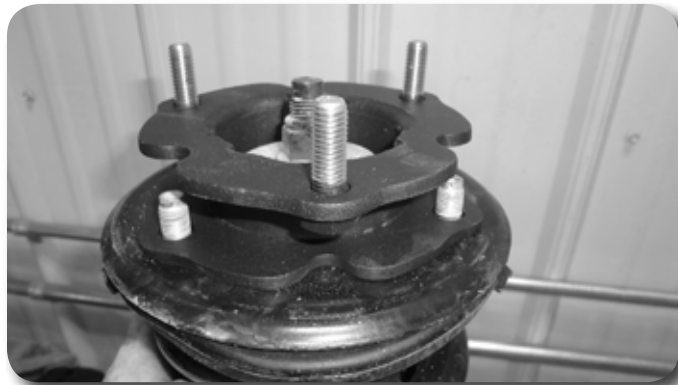

Figure 15

Step 24 Note

Mounting hardware is located in hardware pack #629. The strut will be installed 180 deg. from how it was removed.

24. Install the strut assembly back in the vehicle and fasten to the original frame mount with the provided 10mm nuts and washers. Figure 16 Torque nuts to 45 ft-lbs.

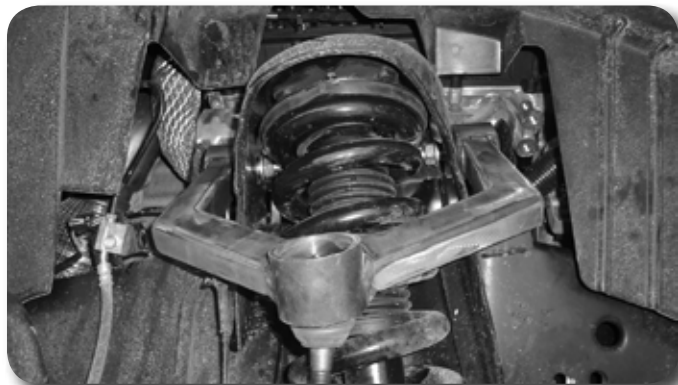

Figure 16

25. Swing the lower control arm up and fasten to the strut with the original factory hardware. Leave hardware loose.
26. Reattach the upper ball joint to the knuckle. Use the jack to support the lower control arm and torque the upper ball joint nut to 40 ft-lbs.
27. Reattach the steering tie rod to the knuckle and torque the factory nut to 44 ft-lbs. Using a tape measure approximately set the toe within +/- 0.25". This is only temporary since the truck MUST be aligned after the install is completed.
28. Repeat the strut removal/assembly on the opposite side of the vehicle.
29. When both sides are complete, reattach the sway bar links and tighten factory hardware to the lower control arms.
30. With both sides assembled, install the wheels and lower the vehicle to the ground. Torque lug nuts to factory specifications.
31. Bounce the front of the vehicle to settle the suspension. Torque the lower control arm cam bolts, upper control arm bolts, and the lower strut bolts to factory specifications. Line up the marks previously made on the cam bolt to the frame when tightening the lower control arms.

» REAR INSTALLATION

32. Block the front wheels. Safely raise the rear of the vehicle and support with jack stands just ahead of the front leaf spring frame mount.
33. Remove the wheels.
34. Support the rear axle with a floor jack.
35. Remove the ABS lines from the retaining clip on the axle.
36. Support the center of the axle with a hydraulic jack. Remove the factory shocks from the axle and frame. Save hardware and discard shocks.
37. Remove the factory sway bar links **Figure 17**. Discard hardware and links.

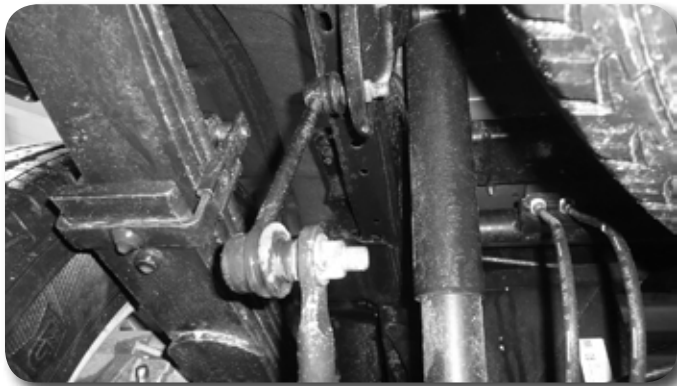

Figure 17

38. With the axle still well support remove the passenger's side u-bolts. Be sure not to over extend any brake lines or ABS wires.
39. Lower the axle just enough to install the new provided lift block between the axle and the spring. Install new rear block with the small end of the block pointing towards the front of the vehicle. Align the pin in the block with the hole in the axle and the hole in the block with the leaf spring pin. It may be necessary to loosen the driver's side u-bolts slightly to allow the axle to lower far enough to install the block.
40. Using the support jack, raise the axle so that the axle, spring and block are all touching. Install the new provided u-bolts, nuts and washers allow with the factory u-bolt plate. Snug u-bolts but do not tighten **Figure 18**.



Figure 18

41. Repeat the installation on the driver's side of the vehicle. Pay special attention to all of the brake lines and wires. Do not allow them to get over-extended.
42. Locate the new rear shocks. Install the provided bushings and steel sleeves into the eyes of the shocks. Lubricating the bushings and sleeves with some grease will make installation easier. The lower shock sleeve will be longer one with two 1/4" spacer washers on each side to center the shock in the lower mount **Figure 19**.

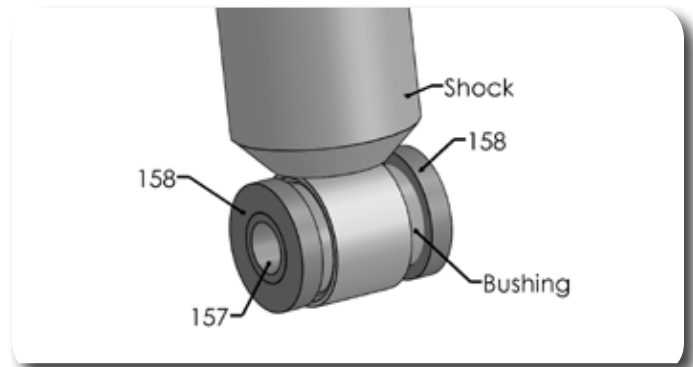

Figure 19

Step 44 Note

Mounting hardware is located in Bolt Pack 795

43. Install the new shocks with stock hardware and torque upper and lower bolts to 65 ft-lbs.
44. Install the provided hourglass bushings and sleeves in the new extended sway bar links. Install the links with the provided 12mm hardware **Figure 20**. Torque hardware to 60 ft-lbs.



Figure

45. Install wheels and tires. Torque lug nuts to 140 ft-lbs. Lower vehicle.
46. Bounce the rear of the vehicle to settle the suspension. Torque leaf spring u-bolts to 100-120 ft-lbs.

» **POST-INSTALLATION**

47. Double check all fasteners for proper torque.
48. Check all moving parts for clearance.
49. Complete a full radius turning check to ensure that no interference occurs.
50. Align headlights
51. Double check the brake lines for adequate slack at full wheel travel.
52. Complete a vehicle alignment.
53. Check all fasteners after 500 miles

Post-Installation Warnings

1. Check all fasteners for proper torque. Check to ensure for adequate clearance between all rotating, mobile, fixed, and heated members. Verify clearance between exhaust and brake lines, fuel lines, fuel tank, floor boards and wiring harness. Check steering gear for clearance. Test and inspect brake system.
2. Perform steering sweep to ensure front brake hoses have adequate slack and do not contact any rotating, mobile or heated members. Inspect rear brake hoses at full extension for adequate slack. Failure to perform hose check/ replacement may result in component failure.
3. Perform head light check and adjustment.
4. Re-torque all fasteners after 500 miles. Always inspect fasteners and components during routine servicing.