



F2662 Installation Instructions 2021-2022 Ford F150 4WD 4-6" Suspension Systems

Read and understand all instructions and warnings prior to installation of product and operation of vehicle.

Zone Offroad Products recommends this system be installed by a professional technician. In addition to these instructions, professional knowledge of disassembly/ reassembly procedures and post installation checks must be known. Minimum tool requirements include the following: Assorted metric and standard wrenches, hammer, hydraulic floor jack and a set of jack stands. See the "Special Tools Required" section for additional tools needed to complete this installation properly and safely.

»» **PRODUCT SAFETY WARNING**

Certain Zone Suspension Products are intended to improve off-road performance. Modifying your vehicle for off-road use may result in the vehicle handling differently than a factory equipped vehicle. Extreme care must be used to prevent loss of control or vehicle rollover. Failure to drive your modified vehicle safely may result in serious injury or death. Zone Offroad Products does not recommend the combined use of suspension lifts, body lifts, or other lifting devices.

You should never operate your modified vehicle under the influence of alcohol or drugs. Always drive your modified vehicle at reduced speeds to ensure your ability to control your vehicle under all driving conditions. Always wear your seat belt.

»» **TECHNICAL SUPPORT**

www.zoneoffroad.com may have additional information about this product including the latest instructions, videos, photos, etc.

Send an e-mail to tech-zone@ridefox.com detailing your issue for a quick response.

888.998.ZONE Call to speak directly with Zone tech support.

»» **PRE-INSTALLATION NOTES**

1. Special literature required: OE Service Manual for model/year of vehicle. Refer to manual for proper disassembly/reassembly procedures of OE and related components.
2. Adhere to recommendations when replacement fasteners, retainers and keepers are called out in the OE manual.
3. Larger rim and tire combinations may increase leverage on suspension, steering, and related components. When selecting combinations larger than OE, consider the additional stress you could be inducing on the OE and related components.
4. Post suspension system vehicles may experience drive line vibrations. Angles may require tuning, slider on shaft may require replacement, shafts may need to be lengthened or trued, and U-joints may need to be replaced.
5. Secure and properly block vehicle prior to installation of Zone Offroad Products. Always wear safety glasses when using power tools.
6. If installation is to be performed without a hoist, Zone Offroad Products recommends rear alterations first.
7. Due to payload options and initial ride height variances, the amount of lift is a base figure. Final ride height dimensions may vary in accordance to original vehicle attitude. Always measure the attitude prior to beginning installation.

Difficulty Level

easy 1 2 3 **4** 5 difficult

Estimated installation: 8-10 hours

Special Tools Required

See Pre-Installation Notes

Tire/Wheel Fitment

6" Lift:

35x12.50 on 18x9 or 20x9 and 4.5-5" BS

*37x12.50 on 20 x 9 and 5.5-5.75" BS

35x12.50 w/20 x 9 and 4.5-5.75" BS

4" Lift:

*35x12.50 on 18x9 or 20x9 4.5-5" BS

295/70 on 18 x 9 and 4.5-5" BS

35x12.50 on 20 x 9 and 5.5-5.75" BS

295/60 on 20 x 9 and 4.5-5.75" BS

*Trimming Is Required

Minor trimming may be required

See Pre-Installation Notes for more information

***Important* Verify you have all of the kit components before beginning installation.**

F2660- Knuckle Box - Drv

Qty	Description
1	Knuckle - Driver

F2661 Knuckle Box - Pass

Qty	Description
1	Knuckle - Passenger

F2662 Front Box Kit

Qty	Description
1	Front Crossmember
2	Sway Bar Drop Brackets
1	Differential Skid Plate
1	Front Brake Line Bracket - Driver
1	Front Brake Line Bracket - Passenger
8	Eccentric Cam Washer
4	Eccentric Cam Bolts
1	Thread Locker
1	10" Vent Hose
1	1/4" Drive Shaft Spacer
4	"Oval Fir Tree" Cable Tie
4	Cable Tie
1	Zone Offroad Crossmember Badge
1	Bolt Pack 886 - Badge Hardware
2	3/16" Stainless Steel Rivet
1	Bolt Pack 828 - Driveshaft Spacer
6	10mm-1.50 x 75mm Socket Head Bolt

F2663 Front Box Kit

Qty	Description
1	Rear Crossmember
1	Driver Side Differential Drop Bracket
1	Driver Side Differential Support Bracket
1	Passenger Side Differential Drop Bracket
1	Passenger Side Differential Support Bracket
1	Bolt Pack 893 - Differential Drop/Misc
3	9/16"-12 x 4" Bolt, Grade 8, Yellow Zinc
4	9/16"-12 x 1-1/4" Bolt, Grade 8, Yellow Zinc
14	9/16" SAE Washer, Yellow Zinc
7	9/16"-12 Prevailing Torque Nut, Yellow Zinc
4	7/16"-14 x 1-1/4" Bolt, Grade 8, Yellow Zinc
8	7/16" SAE Washer, Yellow Zinc
4	7/16"-14 Prevailing Torque Nut, Yellow Zinc
2	18mm-2.50 x 150mm Bolt, Class 10.9, Clear Zinc
4	3/4" SAE Washer, Clear Zinc
6	18mm-2.50 Prevailing Torque Nut, Clear Zinc
2	8mm-1.25 x 18mm Bolt, Class 8.8, Clear Zinc
2	5/16" SAE Washer, Clear Zinc
4	1/2"-13 x 1-1/4" Bolt, Grade 8, Yellow Zinc
6	1/2" SAE Washer, Yellow Zinc
2	1/2"-13 Prevailing Torque Nut, Yellow Zinc

F2404 /F2604 Strut Spacer Box Kit

Qty	Description
2	Strut Spacer
1	Bolt Pack - 769 - Strut Spacer
6	7/16"-14 Nylock Nut, Clear Zinc
6	3/8" USS Washer, Clear Zinc
1	Bolt Pack 629 - Strut Spacer
6	10mm-1.50 Prevailing Torque Nut, Clear Zinc
6	3/8" USS Washer, Clear Zinc

F2638 5" Rear Box Kit (6" Kit Option)

Qty	Description
2	5in Rear Block
2	Lower Spring Plate
2	Upper Spring Plate
1	Brake Line Bracket
2	1/2" x 4" Center Pin & Nut
4	9/16 x 3-1/8 x 12-1/2 Square U-bolt
1	Bolt Pack 895
1	5/16"-18 x 1" Bolt, Grade 5, Clear Zinc
2	5/16" SAE Washer, Clear Zinc
1	5/16"-18 Prevailing Torque Nut, Clear Zinc
2	1/2"-20 x 3-1/2" Bolt, Grade 8 - Flat SHCS - Black Oxide
2	1/2"-20 Nut - Black Oxide)
8	9/16"-18 High Nut, Non-Locking, Black
8	9/16" SAE Washer, Black

F1406 4" Rear Box Kit (6" Kit Option)

Qty	Description
1	4" Rear Block (Driver)
1	4" Rear Block (Passenger)
1	9/16 x 3-1/8 x 12 Radiused Square U-bolt
1	Brake Line Bracket
1	Bolt Pack 896
1	5/16"-18 x 1" Bolt, Grade 5, Clear Zinc
2	5/16" SAE Washer, Clear Zinc
1	5/16"-18 Prevailing Torque Nut, Clear Zinc
8	9/16"-18 High Nut, Non-Locking, Black
8	9/16" SAE Washer, Black
2	10mm-1.25 x 80mm Bolt, Grade 8.8, Clear Zinc
2	10mm Flat Washer, Clear Zinc

F2417 3-1/4" Rear Box Kit (4" Kit Option)

Qty	Description
2	3-1/4" Rear Block
1	9/16 x 3-1/8 x 12 Radiused Square U-bolt
2	Bump Stop Extension
1	Brake Line Bracket
1	Bolt Pack 896

F1206 2" Rear Box Kit (4" Kit Option)

Qty	Description
2	2" Rear Block
1	9/16 x 3-1/8 x 12 Radiused Square U-bolt
2	Bump Stop Extension
1	Brake Line Bracket
1	Bolt Pack 896

F2605 6" Lift, 5" Rear CCD Box Kit

Qty	Description
2	Rear Shock Relocation Bracket - Outer
2	Rear Shock Reloaction Bracket - Inner
1	Front Sensor Relocation - Driver
1	Front Sensor Relocation - Passenger
1	Bolt Pack 941
2	12mm-1.75 x 80mm Bolt
2	12mm-1.75 Prevailing Torque Nut
4	12mm Washer
1	Bolt Pack 354
2	3/8"-16 x 1-1/4" Bolt
2	3/8"-16 Prevailing Torque Nut
4	3/8" SAE Washer

Important—measure before starting!

Measure from the center of the wheel up to the bottom edge of the wheel opening

LF _____ RF _____

LR _____ RR _____

Installation Instructions

>> PRE-INSTALLATION NOTES

1. Some trucks with a 2 piece drive shaft may have a recall from Ford regarding the rear drive shaft. (Safety Recall 21S25) Due to the recall procedure, Zone Offroad recommends to have this performed prior to installing the lift.”
2. 18" or larger diameter wheels required. Stock 17" and 18" wheels cannot be re-installed. Stock 20" wheels can be used with up to a 305/60R20 tire.
3. 18" wheels with 5-5.5" backspacing should be test fit prior to mounting the tire to ensure proper clearance to the steering knuckle/tie rod. 18 - 20" wheels with 5.5-5.75" of backspacing is highly recommended for tire to frame crash bar clearance. 37" tires will require crash bar modification
4. Models with 2-piece rear driveshaft WILL require carrier bearing shim kit D5405 (not included w/ kit).
5. Block kits replace factory 1-1/4" block. Stock block will not be reinstalled.
6. Crash bars may require modification based on wheel and tire choice. It is the end users responsibility to ensure modifications are non-detrimental to vehicle safety.
7. Does not fit diesel models.
8. Will not fit Tremor models.
9. Requires frame bracket modification
10. Will fit models with 4 Auto that do not have the 4WD actuator hub assembly.
11. Special Tools Required:
 - Reciprocating saw or equivalent
 - Special Service Tool: 204-592 Separator
 - Tie Rod End Separator

>> FRONT INSTALLATION

1. Park the vehicle on a clean, flat surface, and block the rear wheels for safety.
2. Raise the front of the vehicle and support with jack stands at each frame rail behind the lower control arms.
3. Remove the front wheels.
4. If equipped, remove the factory skid plates / splash guards **Figure 1A / B**.

Caution

EPAS (Electronic Power Assist Steering), disconnect the power steering control module connector to avoid arcing of the contacts in the internal power relay from a hammer blow or impact wrench.



Figure 1A



Figure 1B

5. Remove the brake caliper anchor bracket bolts and remove the caliper from the knuckle **Figure 2**. Hang the caliper out of the way. Do not let the caliper hang by the brake hoses.

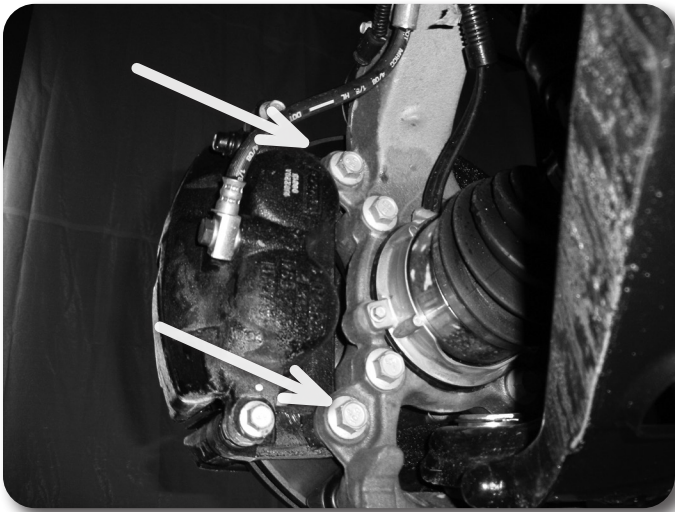

Figure 2

Step 8 Note:

Be careful not to damage the 4wd actuator hub assembly if it is kept attached to the vehicle and hanging.,

6. Remove the brake rotor and set aside.
7. Remove the dust shield from the knuckle and set aside.
8. Disconnect the ABS and 4wd actuator hub assembly lines from the retaining clips **Figure 3A**. Remove the ABS sensor from the hub **Figure 3B**.

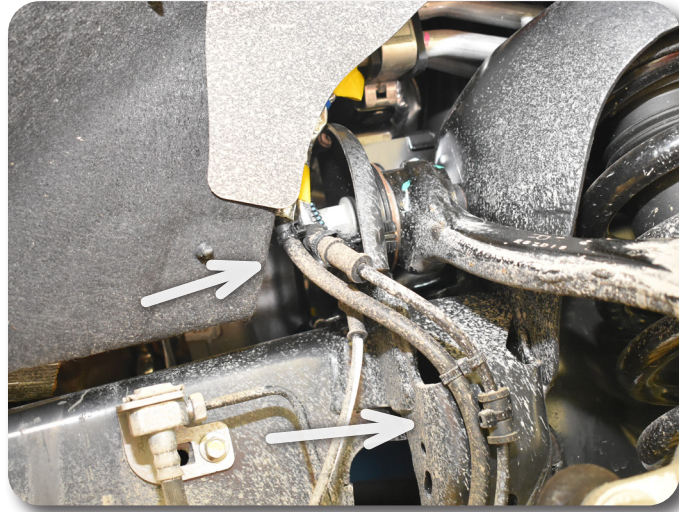

Figure 3A

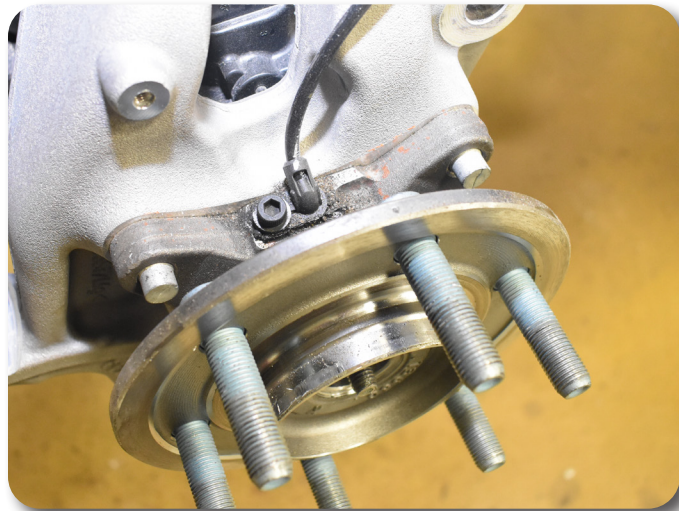

Figure 3B

9. Remove the clip attaching the brake line to the brake line bracket, save clip for later installation. Disconnect the brake line bracket from the frame rail **Figure 4A**. Slide the bracket up the brake line and carefully cut a slit in the factory brake line bracket so that it can be removed from the truck. Disconnect the brake line bracket from the steering knuckle **Figure 4B**.



Figure 4A

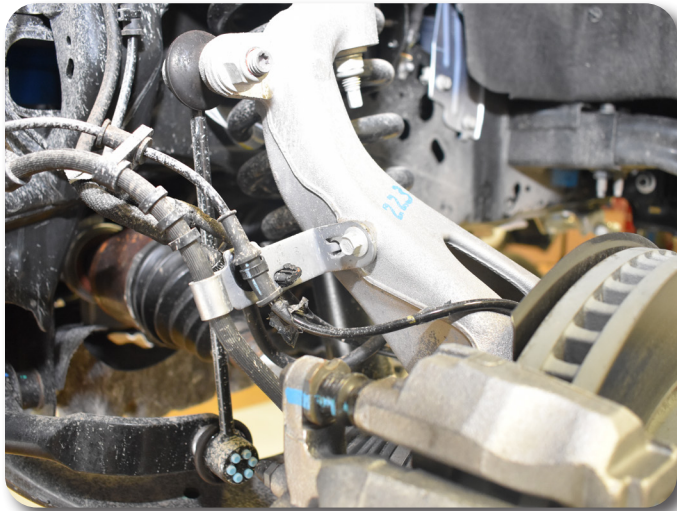

Figure 4B

10. Disconnect the tie rod ends from the steering knuckles. Avoid hitting the aluminum steering knuckle, use appropriate tool to remove tie rod end from steering knuckle. Take care not to strike the tie rod end, or damage the threads and boot Figure 5.

Step 10 Note:

Use a tie rod end separator to release the taper from the steering knuckle.



Figure 5

Step 12 Note:

Do not use power tools to remove the stabilizer bar link nut. Damage to the stabilizer bar link ball joint or boot may occur

11. Disconnect the sway bar links from the steering knuckle **Figure 6A**. The sway bar links do not need to be removed from the sway bar.
12. Remove the four sway bar mounting nuts and remove the sway bar from the vehicle **Figure 6B**.

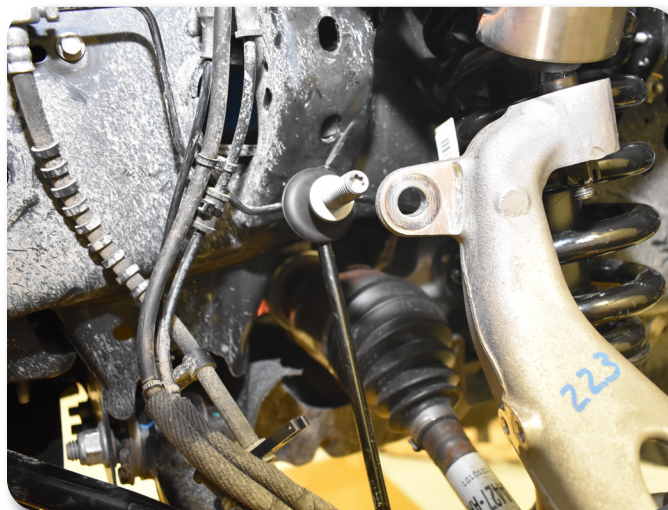

Figure 6A



Figure 6B

13. Carefully remove the hub dust cap to expose the axle shaft nut **Figure 7A / B**. Remove the nut.



Figure 7A

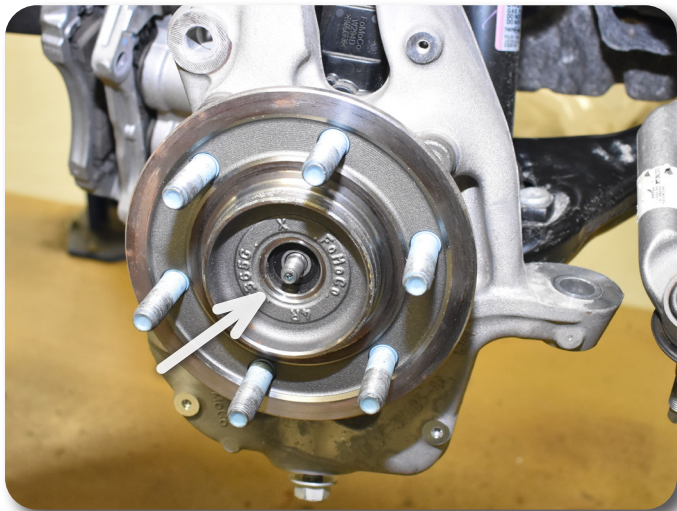

Figure 7B

14. Loosen but do not remove the three strut assembly mounting nuts at the frame **Figure 8**. Do not loosen the middle strut nut.



Figure 8

15. Remove the 4 bolts attaching the 4wd actuator hub assembly to the steering knuckle. **Figure 9** is shown with the CV shaft pulled out for clarity. Note that

some models starting in 2022 will not have the 4wd actuator hub assembly, skip this step if not equipped.

Note: If allowing the 4wd actuator hub assembly to hang make sure it is secured out of the way so it does not get damaged. If removing from the vehicles make sure to mark the locations it was clipped in to the fender for later installation.



Figure 9

16. Loosen but do not remove the upper and lower ball joint nuts **Figure 10A / B**. Unseat the upper and lower ball joints from the knuckle, refrain from hitting the aluminum steering knuckle, use appropriate tool to separate ball joints, avoid damaging the threads and boot.

Step 16 Note:

Use Special Service Tool: 204-592 Separator to release the taper from the steering knuckle.



Figure 10A

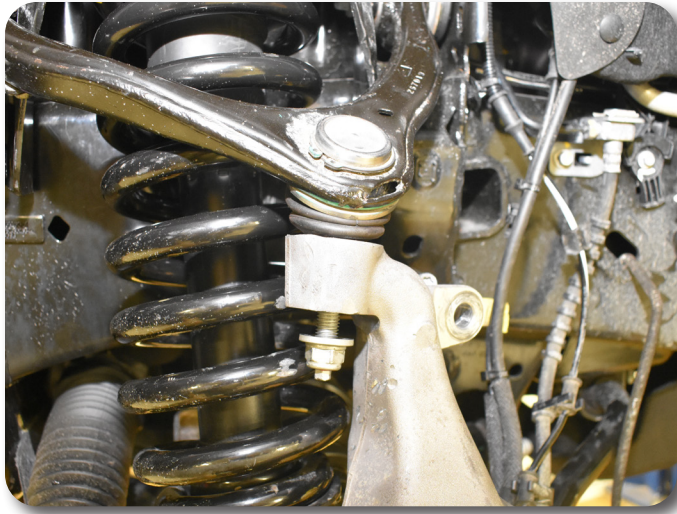

Figure 10B

17. Remove the upper ball joint and the strut-to-lower control arm hardware. Swing the knuckle/lower control arm down to remove the CV shaft from the hub.
18. Remove the lower ball joint nut and remove the knuckle from the vehicle. Secure the 4wd hub actuator so that it is not damaged during the installation. If desired, the actuator can be removed from the vehicle by unclipping the wire harness and breather line from the inner fender / truck.
19. Mark the struts to distinguish between driver's and passenger's.
20. **CCD MODELS ONLY:** Disconnect the sensor on the strut assembly
21. Remove the three strut assembly mounting nuts at the frame and remove the strut assembly from the vehicle.
22. Remove the lower control arm mounting bolts and remove the lower control arm from the vehicle **Figure 11**.



Figure 11

23. Take a wire brush and remove the material from the threads of the four bolts that attach the OE rear cross member. Remove the bolts and cross member from the vehicle. Discard the cross member and hardware **Figure 12**.



Figure 12

24. Remove the drive shaft mounting bolts and disconnect the drive shaft from the differential Figure 13. Allow the drive shaft to rest out of the way. Discard factory drive shaft mounting bolts.



Figure 13

25. **Optional:** Remove the passengers side CV only. Strike the shaft with a hammer to dislodge it from the splines. This will make handling the differential much easier Figure 14.



Figure 14

26. Support the front differential with an appropriate jack. Loosen all of the hardware and slide the differential all the way to the passenger's side. Orientate the joint at the steering rack so there is the most possible clearance to remove the front driver's side bolt. Remove this bolt first. Disconnect the differential breather hose from the differential housing. Remove the rear driver's side and one passenger's side differential mounting bolts **Figure 15A/ B / C** and remove the differential from the vehicle.

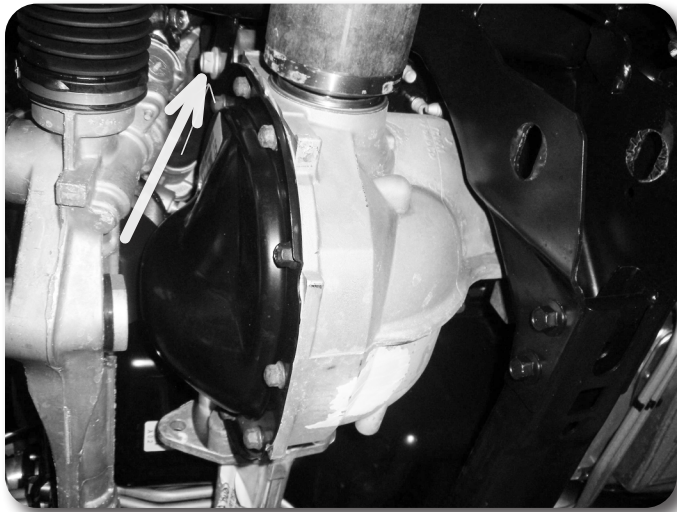

Figure 15A

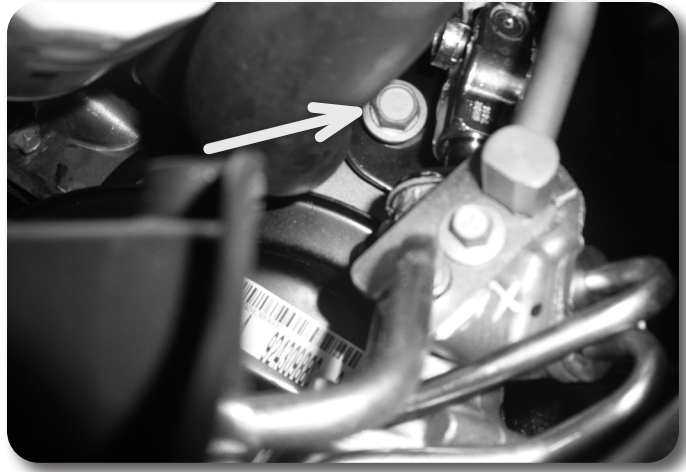

Figure 15B

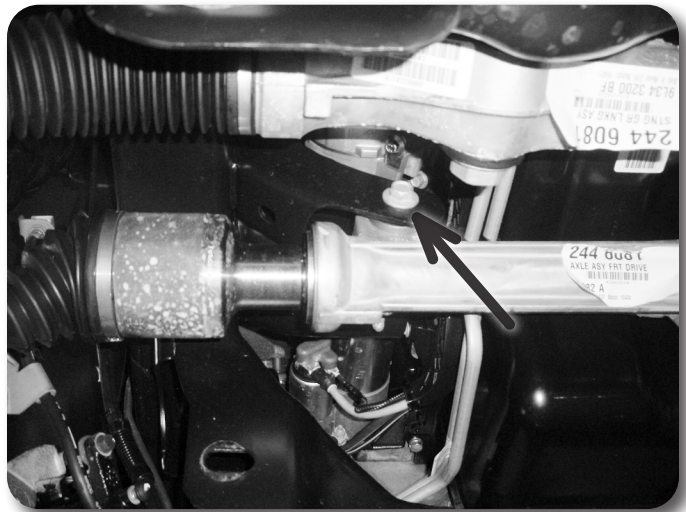

Figure 15C

27. The driver's side rear lower control arm frame pocket must be modified to provide clearance for the differential in its relocated position. On the front side measure from the inside edge of the slot $9/16"$ Figure 16A / B. Make a vertical cut line at the mark.

Figure 27 Note:
Measure in $9/16"$ from inside of slot edge.

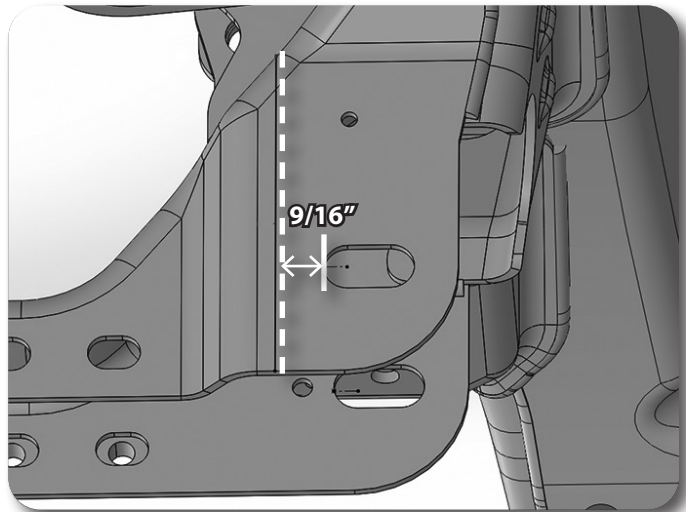

Figure 16A



Figure 16B

28. On the back side measure from the inside edge of the slot $9/16''$ and make / mark a vertical cut Figure 17A.
29. Connect the front cut line straight to the back face. This will require trimming on the factory differential mount tab Figure 17B / C.

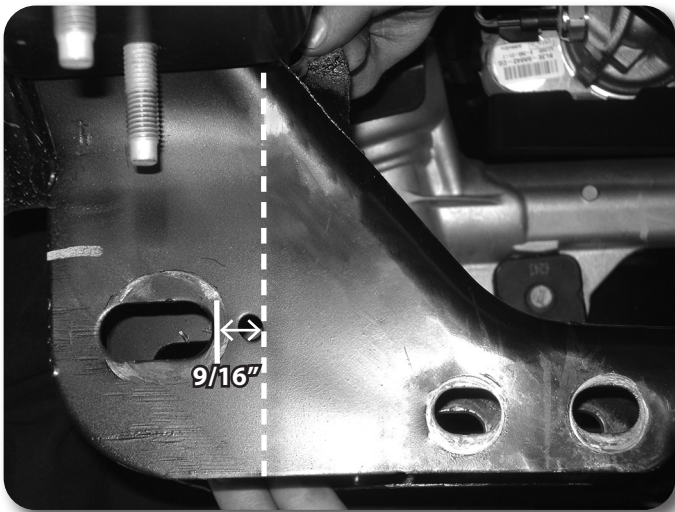

Figure 17A

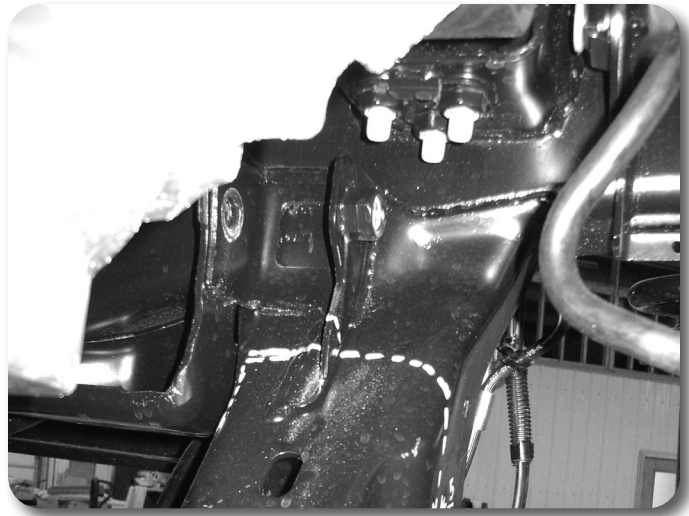

Figure 17B



Figure 17C

Step 30 Note:

Hardware for the differential drop brackets to differential is in Bolt Pack 893.

30. Attach the differential relocation brackets to the differential with 9/16" x 4" bolts, washers, and nuts, do not tighten at this time. The passenger side bracket will have a cutout "window" in the bracket for clearance to the steering rack **Figure 18A**. Run the hardware from front to rear. Both brackets will be installed with the 2 holes towards the rear of the vehicle. Raise the differential with the brackets attached into the vehicle by aligning the differential mounts in the two front drop brackets attach to the frame with OE hardware **Figure 18B**.

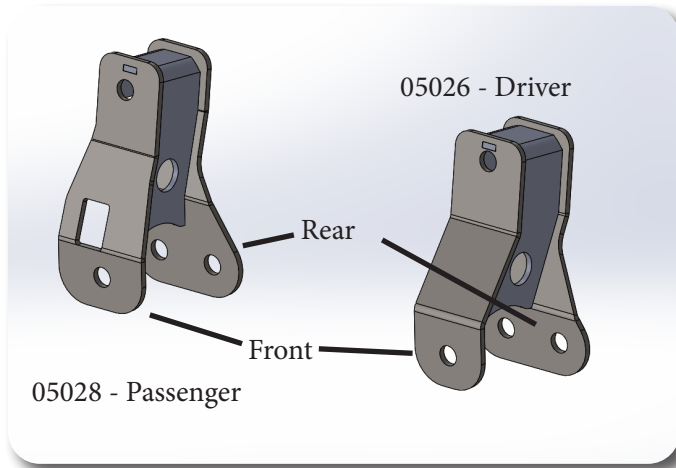

Figure 18A



Figure 18B

31. The rear bushing will need to be modified to provide clearance to the frame pocket. Use a hammer to dent the edge over on the bushing cup that is pressed into the front differential **Figure 19A / B**. Dent this over until the outer ridge is touching the aluminum housing. This will NOT affect the performance of the differential bushing, but will provide clearance to the frame.

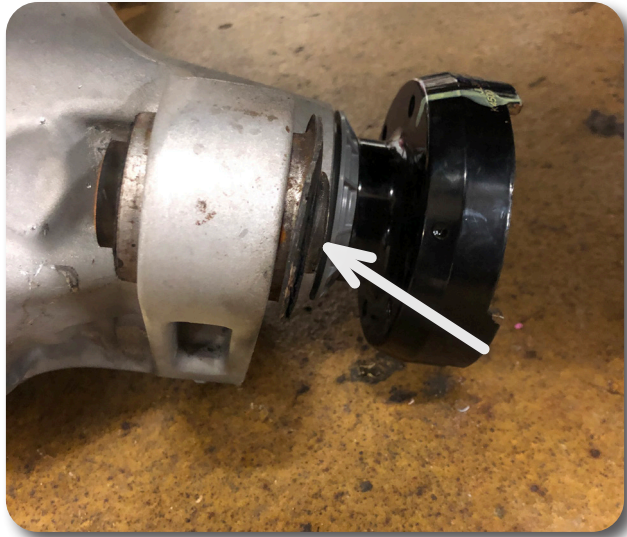

Figure 19A

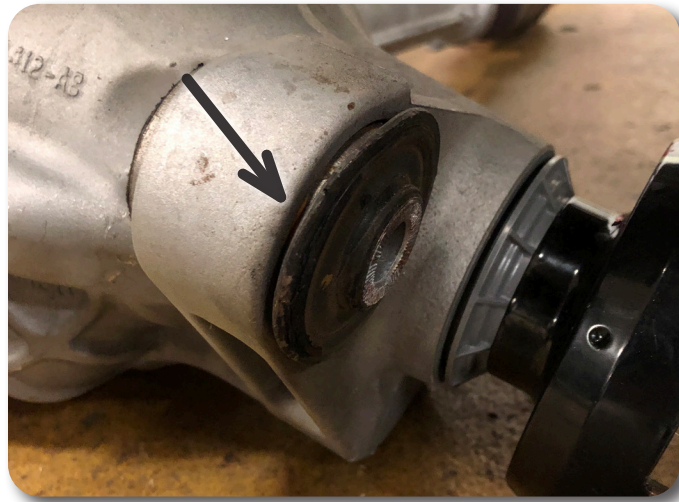

Figure 19B

Step 32 Note:

Hardware for the cross member / sway bar drop to frame is in Bolt Pack 893.

Step 32 Note:

Check clearance on the passenger side between the frame and rear crossmember. The factory frame crossmember mount may need to be cleared out due to factory frame variance.

If the hardware is difficult to install it might be necessary to open up the factory cam slot due to frame mounting width variances

Step 33 Note:

Hardware for the differential mount is in Bolt Pack 893.

32. Install the new rear cross member in the rear lower control arm frame pockets. Attach the rear cross member with the sway bar drop brackets with new 18mm bolts and washers. Run bolts from rear to front (Figure 20A). Leave hardware loose. Ensure the cutout made in the previous step is adequate to clear the differential mounting bolt Figure 20A. Do not tighten hardware at this time.
33. Fasten the differential to the rear cross member (Figure 20B) with a 9/16" x 4" bolt, washers, and nut. Run the bolt from rear to front. Leave hardware loose.



Figure 20A



Figure 20B

34. Fasten the driver's side differential support bracket to the rear of the driver's differential drop bracket. Fasten with the driver's side rear cross member hardware along with a 9/16" x 1-1/4" bolt, washer, and nut. Attach the hardware at the differential bracket from the front to rear. Leave all hardware loose at this time Figure 21.

Step 34 Note:
Hardware for the differential support bracket is in Bolt Pack 893.

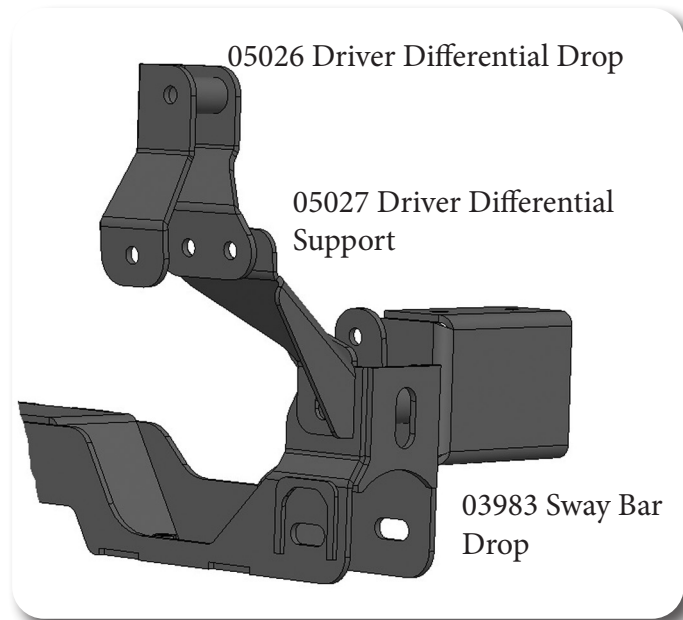

Figure 21

Step 35 Note:

Hardware for the differential support bracket is in Bolt Pack 893.

35. Install the passenger's side differential support bracket to the backside of the passenger's side differential bracket using the hardware that was just installed and a 9/16" x 1-1/4" bolt, washers, and nut. Attach the differential support bracket to the rear cross member with two 9/16" x 1-1/4" bolt, washers, and nuts. Leave hardware loose Figure 22.

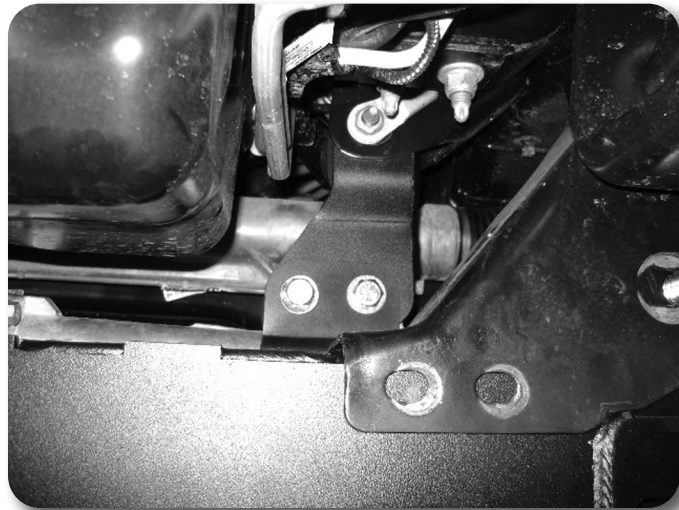

Figure 22

36. Torque all of the differential mounting hardware to 95 ft-lbs.
37. Attach the differential breather tube. Remove the differential breather elbow from the plastic line and replace it with the provided hose and attach it to the differential.
38. Install the front cross member in the front lower control arm pockets and fasten with the OE lower control arm hardware running hardware from front to rear. Leave hardware loose.
39. Install the lower control arms in the new cross members and fasten with the provided 18mm cam bolts, cam washers and 18mm nuts. Run the front bolts from front to rear and leave loose. Run the rear bolts from rear to front. The main body of the cam will be 'up' in the cam slot

Step 39 Note:

Nuts for the cam bolts are in Bolt Pack 893.

40. Install the provided differential skid plate to the front and rear cross members with $\frac{1}{2}$ " x $1\text{-}1/4$ " bolts, washers and nuts for the rear cross member. The front cross members have a weld nuts inside the cross members **Figure 23**. Leave hardware loose.

Step 40 Note:
Hardware for the skid plate is in Bolt Pack 893.



Figure 23

41. Attach the sway bar drop brackets to the frame using the factory nuts and nut tabs. Snug but do not tighten at this time.

 **Tip** Use a ratchet extension through the lower slots to access the hardware (Figure 24A / B)

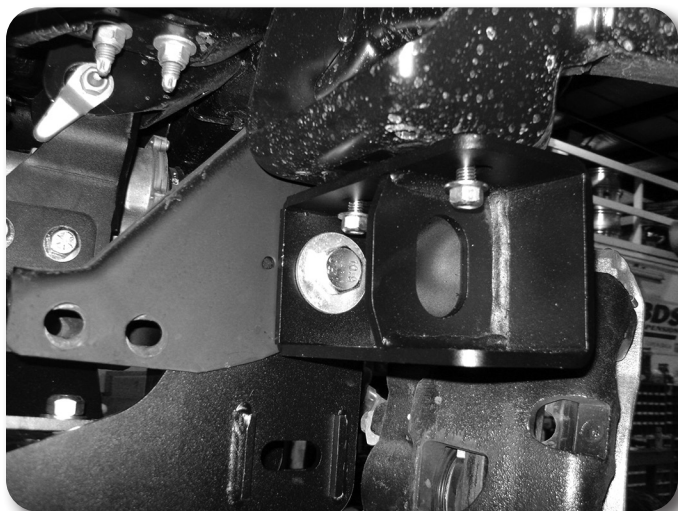

Figure 24A

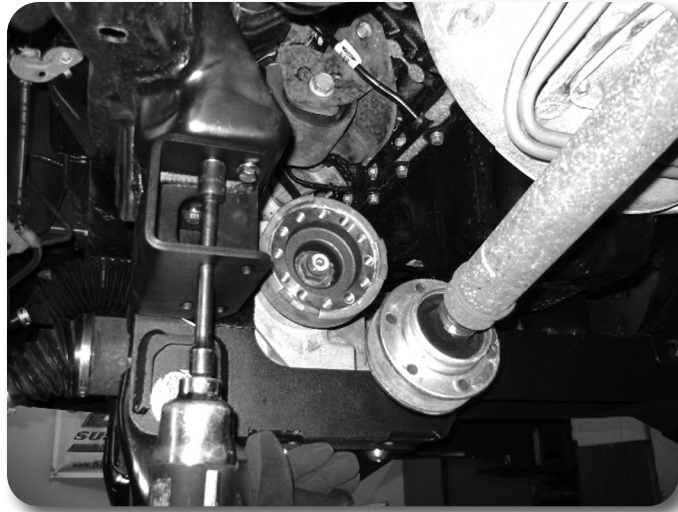

Figure 24B

42. With the lower control arms installed torque the four cross member mounting bolts to 222 ft-lbs. Ensure that the front cross member is centered in the vehicle. Torque the differential skid plate bolts to 65 ft-lbs. Tighten sway bar drop hardware to 35 ft-lbs.
43. Reinstall the passengers side CV (If removed).

Step 44 Note:

Hardware for the strut spacer to strut is in Bolt Pack 629.

Step 45 Note:

Hardware for the strut spacer to frame is in Bolt Pack 769.

>> STRUT INSTALLATION

44. The same strut spacer is used on both sides. Place the strut spacer on each strut and attach with new 10mm nuts. Tighten to 40 ft-lbs.
45. Install the strut and spacer assembly into the vehicle. Attach to upper mount with new 7/16" nuts and washers. Leave hardware loose at this time Figure 25.



Figure 25

>> 4" AND 6" - ALL KITS

46. Remove the four hub bolts from the knuckle and remove the hub from the knuckle Figure 26. Inspect mounting surface of the hub assembly and clean any dirt or corrosion off as necessary.

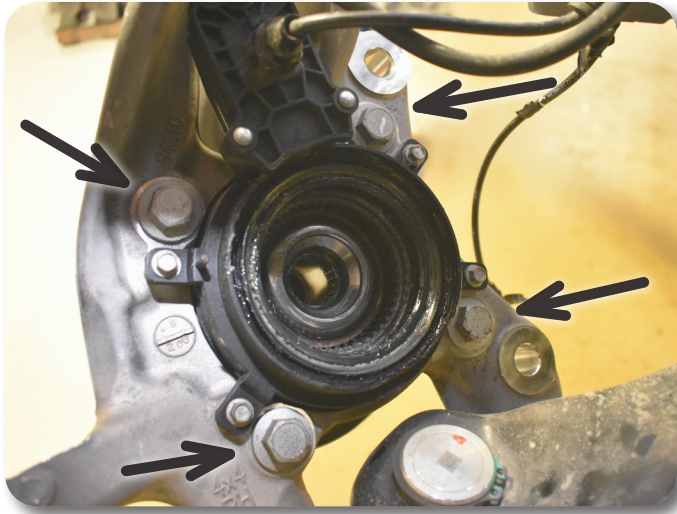

Figure 26

47. Install the hub into the corresponding new Zone knuckle and fasten with OE bolts. The ABS wire will be located at the 'top' of the hub. Use thread locker on the bolt threads and torque to 148 ft-lbs.
48. If not previously removed; remove the (4) 6mm bolts mounting the 4wd actuator hub assembly to the inside of the OE knuckle Figure 27. Transfer the 4wd actuator hub assembly over to the new knuckle. The assembly can install with the 4wd actuator hub assembly towards the "top" of the knuckle. Attach with OE bolts, tighten bolts securely (about 5-7 ft-lbs). Note that some models starting in 2022 will not have the 4wd actuator hub assembly, skip this step if not equipped.

Step 48 Note:

If the 4wd actuator hub assembly was not removed from the vehicle reinstall the assembly when the knuckle is installed into the vehicle. Make sure the CV shaft is inserted through the assembly and be careful not to damage the 4wd hub actuator assembly.

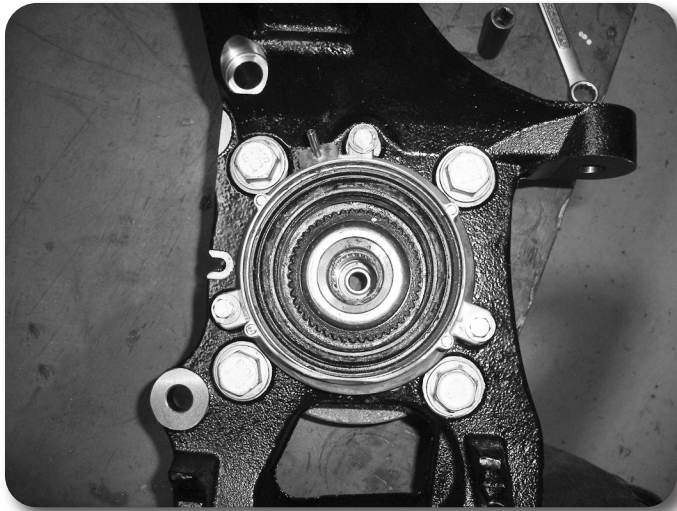

Figure 27

49. Install the new knuckle assembly on the lower control arm ball joint and loosely fasten with the original nut. Install the CV shaft in the hub, swing the whole assembly up and attach the lower control arm to the strut with the original hardware. Leave all hardware loose.
50. Attach the upper control arm to the knuckle with an OE nut.
51. Torque the upper ball joint to 85 ft-lbs
52. Torque the lower ball joint to 111 ft-lbs.
53. Torque the upper strut nuts to 35 ft-lbs.

54. Torque the lower strut mount bolts to 66 ft-lbs
55. Fasten the CV shaft to the hub with the an OE nut. Make sure the splines are engaged properly in the 4wd actuator hub assembly section of the hub. The hub should have a very minor amount of rotational play with the CV shaft if installed properly, torque to 30 ft-lbs. Reinstall the dust cap. *Note: Trucks that do NOT have the IWE / 4wd actuator hub assembly, that DO have the large diameter axle nut, torque the nut to 221 ft-lbs.*
56. Install tie rod from top-down with an OE nut. Torque to 111 ft-lbs.
57. Install the brake line relocation brackets at the frame with an OE bolt. Attach the brake line to the new bracket using the clip removed previously **Figure 28**.



Figure 28

Step 60 Note:

Hardware for the sway bar to sway bar drop is in Bolt Pack 893.

Step 60 Note:

Do not use power tools to attach the stabilizer bar link nut. Damage to the stabilizer bar link ball joint or boot may occur

Step 61 Note:

Hardware for the brake line bracket to knuckle is in Bolt Pack 893.

58. Install the dust shield with the factory 6mm bolts, tighten bolts securely (about 5-7 ft-lbs).
59. Install the brake rotor and caliper to the knuckle with OE bolts using thread locker. Torque to 148 ft-lbs.
60. Install the sway bar to the new sway bar drop brackets with 7/16" x 1-1/4" bolts, nuts and 7/16" SAE washers. Attach the sway bar end links to the steering knuckles with an OE nut. Torque the 7/16" hardware to 45 ft-lbs. Torque sway bar link nut to 111 ft-lbs.
61. Attach the ABS line to the connector at the inner fender and the 4wd actuator hub assembly line to the hub if disconnected. Route the lines similar to the factory setup down to the side of the knuckle. Attach the brake line with a new 8mm x 18mm bolt with 5/16" washer to the side of the knuckle, the brake line locating tab will go into the un-threaded hole **Figure 29A / B**. Use the provided "oval fir tree" cable ties as needed along with regular cable ties to hold the ABS / 4wd actuator hub assembly lines out of the way of the tire and sway bar.

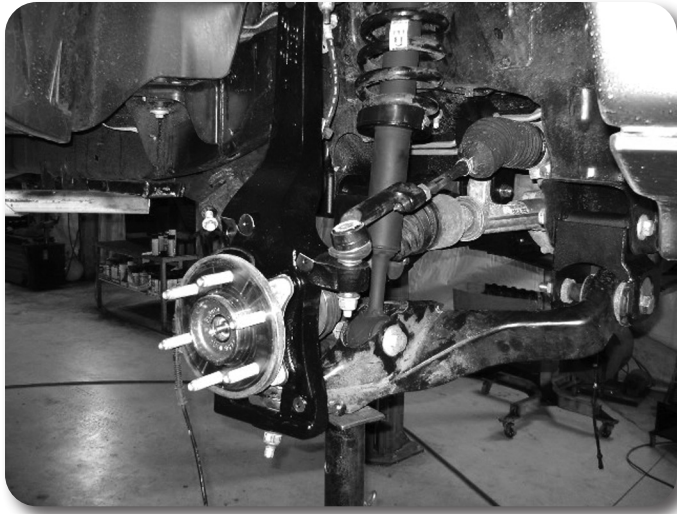

Figure 29A

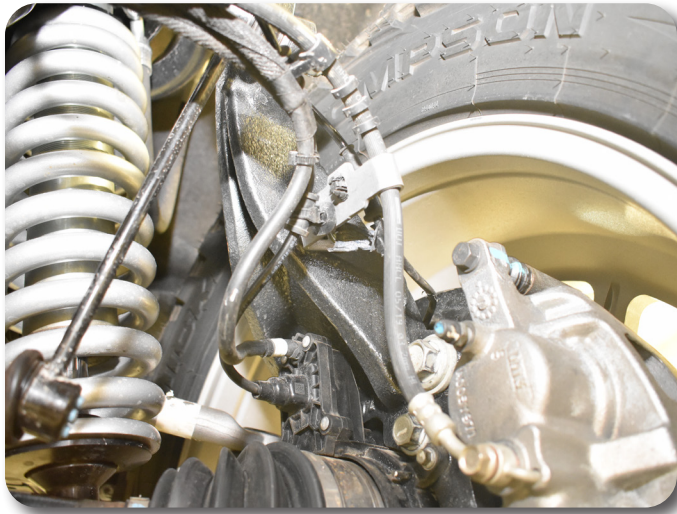

Figure 29B

» **CCD MODELS ONLY, SKIP AHEAD TO STEP 65 IF NOT EQUIPPED WITH CCD**

62. Reconnect the CCD sensor to both strut assemblies. The line will need to be rerouted up the strut and to the frame. Cut any factory cable ties from the sensor wire and remove any plastic retaining clips to reroute the wire. **Figure 30.** Use the provided “oval fir tree” cable ties as needed along with regular cable ties to hold the CCD sensor lines out of the way of the tie rod boot and coil spring. **Figure 31A/B, pass side. Figure 32A/B driver side.**

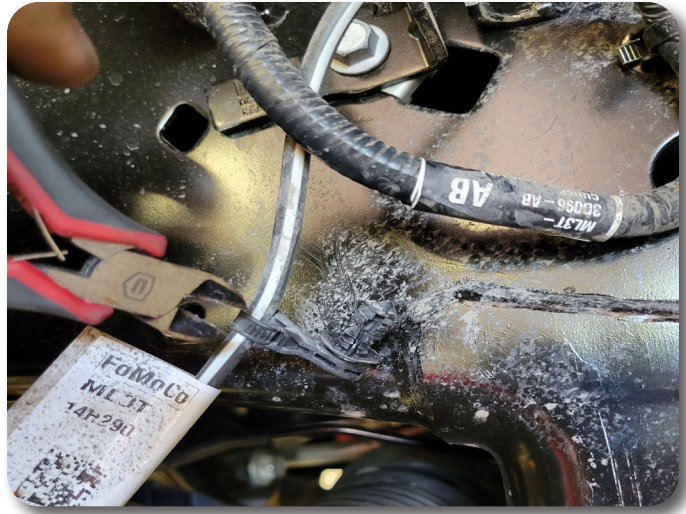

Figure 30



Figure 31A



Figure 31B

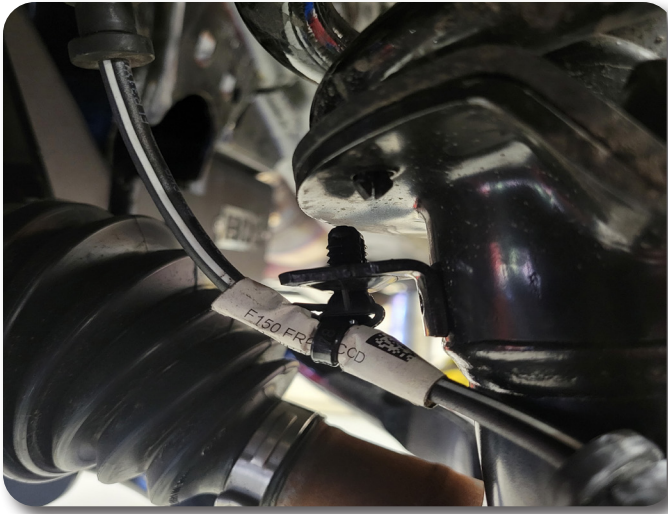

Figure 32A

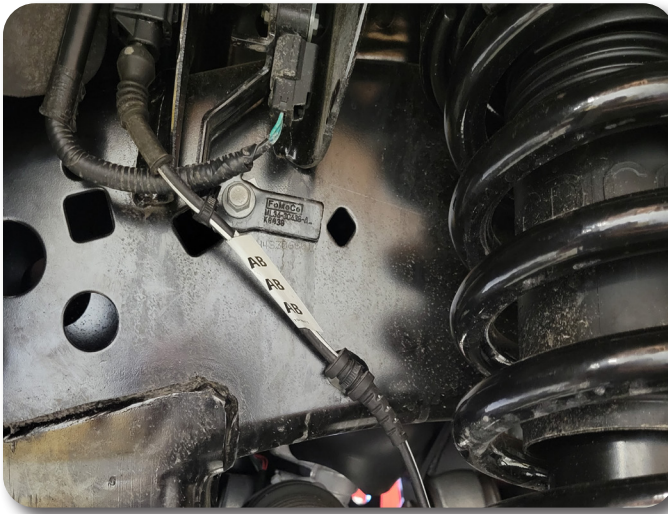

Figure 32B

63. Remove the ride height sensor bracket from the upper control arm and disconnect the nut holding the sensor linkage to the bracket. Figure 33 Retain hardware.



Figure 33

64. Install the supplied sensor relocation brackets to the upper control arms with factory bolts. Torque to 177 in-lbs. Reconnect sensor linkage to the relocation bracket with the factory nut. **Figure 34: Driver Side Shown**



Figure 34

Step 65 Note:

Hardware for the drive shaft spacer is in Bolt Pack 828.

65. Install the supplied 1/4" drive shaft spacer and reattach front drive shaft to differential with new hardware. Torque bolts to 41 ft-lbs **Figure 35.**



Figure 35

Step 66 Note:

Rivets for the "Zone Offroad" badge are in Bolt Pack 886.

66. The "Zone Offroad" badge can now be riveted on to the front cross member using the provided 3/16" rivets **Figure 36.** Any residue on the badge can be cleaned up using alcohol or brake cleaner before install. With the badge not installed it can be painted to what ever color you desire, or left raw as a stainless steel badge



Figure 36

67. Install the wheels and lower the vehicle to the ground.

68. Bounce the front of the vehicle to settle the suspension. Center the lower control arm cams and torque to 250 ft-lbs. Adjust the toe before driving it to an alignment shop.
69. Cycle steering, the crash bars that protrude from the frame may create clearance issues with the front tires. Modifications may be required for clearance.
70. Check all hardware for proper torque.

» REAR INSTALLATION

71. Block the front wheels and raise the rear of the vehicle. Place jack stands under the frame rails ahead of the spring hangers.
72. Remove the wheels.
73. Disconnect the rear brake line from the frame. Save bolt for later installation.
74. Support the rear axle with a hydraulic jack.
75. Remove the OE shocks. Retain mounting hardware.
76. Remove rear ride height sensor at the leaf spring side if applicable. **Figure 37**



Figure 37

Note: Perform the rear installation on one side at a time.

77. Remove the axle u-bolts on one side of the axle.
78. Lower the axle and remove the OE lift block (if installed), it will not be reused.

» 5" REAR BLOCK KIT INSTALLATION; 4", 3-1/4", OR 2" REAR BLOCK KITS SKIP AHEAD

79. Using C-clamps, clamp the leaf spring pack together on each side of the center pins. Remove the center pins and discard.
80. Place the new bottom plate on the bottom of the leaf pack and secure with new center pin (120400FSCP) in the 'forward' hole and flat head allen bolt through the 'rear' hole (Bolt Pack #895). Install new u-bolt retaining plate on top (02087B), it will be offset 'forward'. Tighten to 35 ft-lbs **Figure 38 & Figure 39 A / B**.

Step 75 Note:

If installing on a CCD equipped truck, only remove bottom shock hardware .

Step 80 Note:

Flat head allen bolt is located in BP #774.

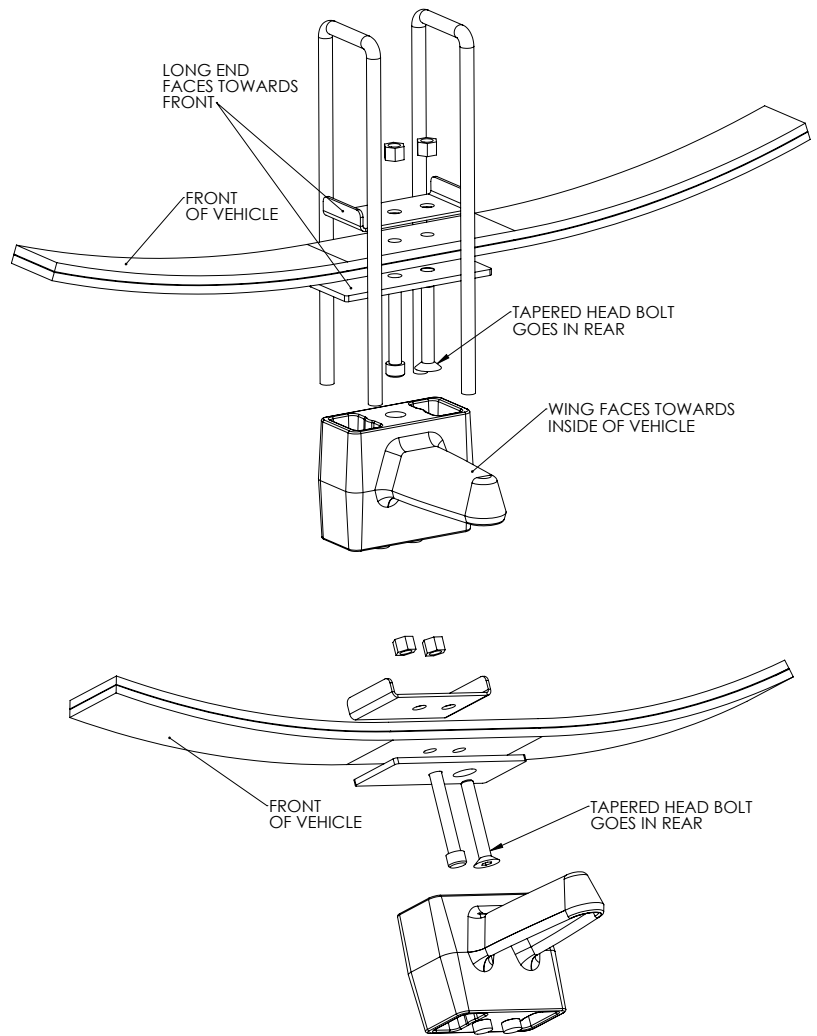

Figure 38

Figure 39 Note:

Trim excess from centerpin and flat head allen bolt.



Figure 39A



Figure 39B

81. Install the new provided lift block so that the bump stop wing goes toward the inside of the vehicle. The block will use the both of the lower center pin holes. The upper only uses 1 hole which will shift the axle slightly forward.
82. Raise the axle/block to the spring while aligning the center pin. Fasten the spring/block assembly with the provided square u-bolts, high nuts and washers (Bolt Pack #895). Snug u-bolts, they will be torqued with the weight of the vehicle on the springs Figure 40.

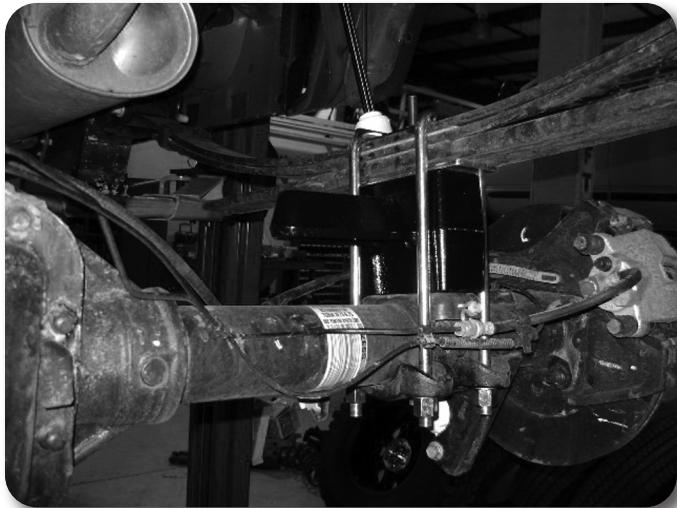

Figure 40

83. Repeat installation procedure on the opposite side of the vehicle.

» 4", 3-1/4", or 2" REAR BLOCK KIT INSTALLATION

84. **4" Block Kits Only:** Install rear block (02429 - DRV side, 02430 - Pass side). The block is designed to offset the axle forward slightly. The bump stop wing will be centered under the bump stop on the frame with the vertical gusset facing towards the front of the vehicle. Align the center pins and raise axle.
85. **3-1/4" or 2" Block Kits Only:** Install the rear blocks. Align the center pins and raise axle.
86. Attach radiused u-bolts with the factory lower u-bolt plate, factory upper u-bolt plate, high nuts and washers (Bolt Pack #896). Snug u-bolts, they will be torqued with the weight of the vehicle on the springs

Step 84 Note

Since the 4" blocks have a bump stop wing on the lift block, a bump stop extension is not needed on the frame. Extra 10mm hardware for the bump stop extension will be in Bolt Pack 896 that will not be used.

87. **3-1/4" or 2" Block Kits Only:** Remove the factory bump stop. There is a bolt in the center of it attaching it to the frame.
88. **3-1/4" or 2" Block Kits Only:** Place the proved bump stop extension between the frame and the bump stop cup and fasten with the provided 10mm x 80mm bolts and washers (Bolt Pack #896). Hold the bump stop extension so it remains centered on the cup as the bolt is tightened **Figure 41**. Tighten hardware to 35 ft-lbs.

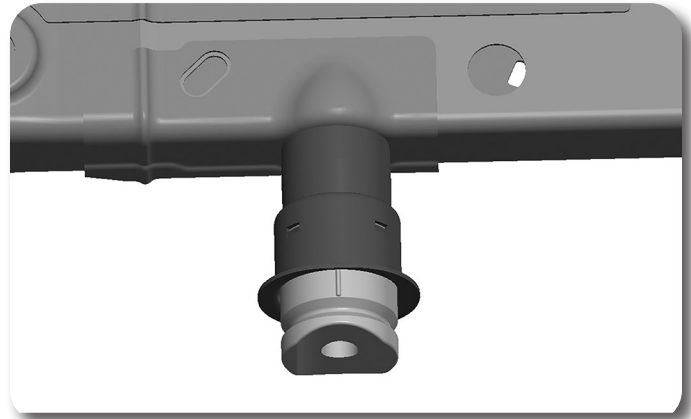

Figure 41

89. Install shock relocation brackets to the axle with supplied sleeve (133) and hardware. (Bolt Pack #354 & #941) Each shock relocation consists of an inside and outside mount. The larger piece (05303) will go on the outside left of the factory bracket and the smaller piece (05304) goes on the inside right. **Figure 42** The driver and passenger side mounts on axle will be identical. Leave hardware loose.



Figure 42

90. Attach lower shock with factory hardware, snug hardware but do not tighten at this time.
91. Torque 3/8" hardware to 44 ft-lbs.

»» **ALL KITS FINAL INSTALLATION**

92. Install the provided brake line relocation bracket (05025) to the driver's side frame rail with the OE brake line bracket bolt **Figure 43**. Torque to 15 ft-lbs.

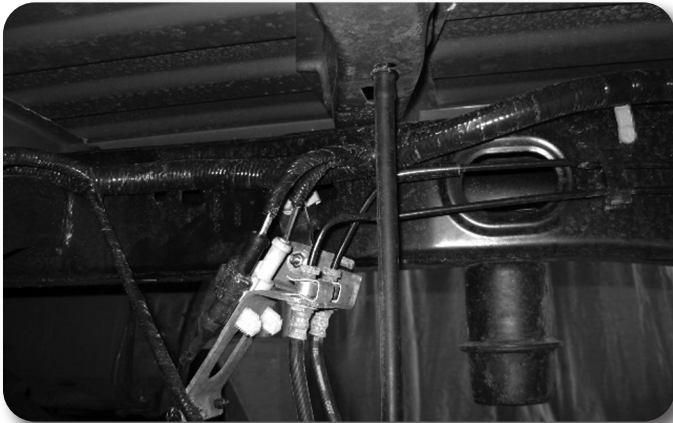

Figure 43

93. Attach the brake line to the relocation bracket with the 5/16" bolt, nut and washer (Bolt Pack #896 or #895). Torque to 15 ft-lbs.
94. Install the provided new shocks (CCD Models reattach factory shocks to axle) with the OE hardware. Torque all shock 22mm hardware to 60 ft-lbs..
95. Install the wheels and lower the vehicle to the ground.
96. Bounce the rear of the vehicle to settle the suspension.
97. Torque the u-bolts to 100-120 ft-lbs.

»» **FINAL INSTALLATION NOTES**

98. Check all lines/wires for proper slack.
99. Reconnect the power steering control module connector.
100. Check all hardware for proper torque
101. Check hardware after 500 miles.
102. A complete front end alignment is necessary.
103. Adjust headlights.

Step 92 Note

Hardware for brake line relocation bracket is located in bolt pack 895 or 896 depending upon which rear lift height kit is used..

Post-Installation Warnings

1. Check all fasteners for proper torque. Check to ensure for adequate clearance between all rotating, mobile, fixed, and heated members. Verify clearance between exhaust and brake lines, fuel lines, fuel tank, floor boards and wiring harness. Check steering gear for clearance. Test and inspect brake system.

2. Perform steering sweep to ensure front brake hoses have adequate slack and do not contact any rotating, mobile or heated members. Inspect rear brake hoses at full extension for adequate slack. Failure to perform hose check/ replacement may result in component failure.

3. Perform head light check and adjustment.

4. Re-torque all fasteners after 500 miles. Always inspect fasteners and components during routine servicing.

Component	Torque (FT-LBS)
<i>9/16" or 14mm Differential Hardware</i>	95
<i>1/2" Differential Hardware</i>	65
<i>18mm Crossmember Hardware</i>	250
<i>1/2" Differential Skid</i>	65
<i>3/8" Sway Bar to Frame Hardware</i>	35
<i>Strut Spacer to Strut Nuts</i>	40
<i>Hub Bolts</i>	145
<i>6mm Vacuum Hub Bolts</i>	106 In-lbs
<i>6mm Dust Shield Bolts</i>	106 In-lbs
<i>Upper Ball Joint Nut</i>	46
<i>Lower Ball Joint Nut</i>	76
<i>Upper Strut Nuts</i>	40
<i>Lower Strut Nuts</i>	66
<i>CV Shaft nut</i>	30
<i>Tie Rod to Steering Knuckle</i>	76
<i>Brake Rotor to Steering Knuckle</i>	184
<i>Brake Line Relocation to Frame</i>	15
<i>Brake Line Bracket to Relocation Bracket</i>	15
<i>6mm Brake Line to Steering Knuckle Bolts</i>	92 In-lbs
<i>7/16" Sway Bar to Sway Bar Drop Hardware</i>	45
<i>Sway Bar Link Hardware</i>	59
<i>Driveshaft Bolts</i>	41
<i>Lower Control Arm Cams</i>	250
<i>Center Pin Nuts</i>	35
<i>Rear Brake Line Relocation Bracket to Frame</i>	15
<i>Rear Brake Line to Relocation Bracket</i>	15
<i>Rear Shocks</i>	60
<i>Rear U-Bolts</i>	100-120