



F2632-F2432 Installation Instructions 2014 Ford F-150 4WD 4" & 6" Suspension System

Read and understand all instructions and warnings prior to installation of product and operation of vehicle.

Zone Offroad Products recommends this system be installed by a professional technician. In addition to these instructions, professional knowledge of disassembly/ reassembly procedures and post installation checks must be known. Minimum tool requirements include the following: Assorted metric and standard wrenches, hammer, hydraulic floor jack and a set of jack stands. See the "Special Tools Required" section for additional tools needed to complete this installation properly and safely.

» PRODUCT SAFETY WARNING

Certain Zone Suspension Products are intended to improve off-road performance. Modifying your vehicle for off-road use may result in the vehicle handling differently than a factory equipped vehicle. Extreme care must be used to prevent loss of control or vehicle rollover. Failure to drive your modified vehicle safely may result in serious injury or death. Zone Offroad Products does not recommend the combined use of suspension lifts, body lifts, or other lifting devices.

You should never operate your modified vehicle under the influence of alcohol or drugs. Always drive your modified vehicle at reduced speeds to ensure your ability to control your vehicle under all driving conditions. Always wear your seat belt.

» TECHNICAL SUPPORT

Live Chat provides instant communication with Zone tech support. Anyone can access live chat through a link on www.zoneoffroad.com.

www.zoneoffroad.com may have additional information about this product including the latest instructions, videos, photos, etc.

Send an e-mail to tech@zoneoffroad.com detailing your issue for a quick response.

888.998.ZONE Call to speak directly with Zone tech support.

» PRE-INSTALLATION NOTES

1. Special literature required: OE Service Manual for model/year of vehicle. Refer to manual for proper disassembly/reassembly procedures of OE and related components.
2. Adhere to recommendations when replacement fasteners, retainers and keepers are called out in the OE manual.
3. Larger rim and tire combinations may increase leverage on suspension, steering, and related components. When selecting combinations larger than OE, consider the additional stress you could be inducing on the OE and related components.
4. Post suspension system vehicles may experience drive line vibrations. Angles may require tuning, slider on shaft may require replacement, shafts may need to be lengthened or trued, and U-joints may need to be replaced.
5. Secure and properly block vehicle prior to installation of Zone Offroad Products. Always wear safety glasses when using power tools.
6. If installation is to be performed without a hoist, Zone Offroad Products recommends rear alterations first.
7. Due to payload options and initial ride height variances, the amount of lift is a base figure. Final ride height dimensions may vary in accordance to original vehicle attitude. Always measure the attitude prior to beginning installation.

Difficulty Level

easy 1 2 3 4 5 difficult

Estimated installation: 8-10 hours

Tire/Wheel Fitment

6" Lift

37x12.50 on 18x9 w/ 5" backspacing

37x12.50 on 20x9 w/ 5.5" backspacing

4" Lift

35x12.50 on 18x9 w/ 5" backspacing

35x12.50 on 20x9 w/ 5.5" backspacing

17" wheels will not fit after installation.
Stock 20's can be reinstalled with stock tires only

Kit Contents

ZONF2632/ZONF2432 Box Kit

Qty	Part
1	Front Crossmember
2	Differential Drop Bracket
1	Differential Drop Bracket - PS
2	6in Strut Spacer (F2632 only)
2	4in Strut Spacer (F2432 only)
1	Differential Vent Hose
1	769 Bolt Pack - Strut Spacers
6	<i>7/16"-14 nylock nut</i>
6	<i>3/8" USS flat washer</i>

ZONF2619 Rear 5" Box Kit

Qty	Part
2	Rear 5" Block
1	E-brake Bracket
2	Lower Spring Plate
2	Upper Spring Plate
4	9/16 x 3-1/8 x 12-1/2 Square U-bolt
2	1/2" x 4" Center Pin
8	9/16" SAE Washer
8	916" Fine High Nut
1	Brake Line Bracket
1	774 Bolt Pack - Rear Components
2	<i>1/2"-20 x 3-1/2" flat head bolt</i>
2	<i>1/2"-20 nut</i>
2	<i>7/16"-14 x 1-1/4" bolt</i>
4	<i>7/16" SAE washer</i>
2	<i>7/16"-14 lock nut</i>
1	<i>1/4"-20 lock nut</i>
1	<i>1/4" USS washer</i>

ZONF2419 Rear 4" Box Kit

Qty	Part
1	Rear 4" Block - Drv
1	Rear 5" Block - Pass
1	E-brake Bracket
4	9/16 x 3-1/8 x 12-1/2 Square U-bolt
8	9/16" SAE Washer
8	916" Fine High Nut
1	Rear Brake Line Bracket
1	704 Bolt Pack - Brake Line Bracket
2	<i>1/4"-20 lock nut</i>
2	<i>1/4" SAE flat washer</i>
1	605 Bolt Pack - E-Brake Bracket
2	<i>7/16"-14 x 1-1/4" bolt</i>
4	<i>7/16" SAE washer</i>
2	<i>7/16"-14 lock nut</i>

ZONF2615 Box Kit

Qty	Part
1	Steering knuckle - Drv

ZONF2616 Box Kit

Qty	Part
1	Steering knuckle - Pass

ZONF2633 Box Kit

Qty	Part
1	Rear Crossmember
2	Sway Bar Drop Bracket
1	Differential Skid Plate
1	Driveshaft Spacer
8	Eccentric Cam
4	3/4" USS Flat Washer
2	M18 x 150 Bolt
2	M18 x 150mm Cam Bolt
2	M18 x 170mm Cam Bolt
6	M18 Lock Nut
2	Brake Line Bracket
1	Loctite - 1ml
1	925 Bolt Pack - Driveshaft Spacer
6	<i>10mm x 100mm socket head bolt</i>
1	781 Bolt Pack - Differential/Misc
2	<i>9/16"-12 x 4" bolt</i>
1	<i>9/16"-12 x 3-3/4" bolt</i>
1	<i>9/16"-12 x 1-1/4" bolt</i>
8	<i>9/16" SAE washer</i>
4	<i>9/16"-12 lock nut</i>
2	<i>1/2"-13 x 3" bolt</i>
4	<i>1/2"-13 x 1-1/4" bolt</i>
8	<i>1/2" SAE washer</i>
2	<i>1/2"-13 lock nut</i>
4	<i>3/8"-16 x 1-1/4" bolt</i>
8	<i>3/8" SAE washer</i>
4	<i>3/8"-16 lock nut</i>
2	<i>1/4"-20 lock nut</i>
4	<i>1/4" SAE washer</i>
2	<i>6mm x 18mm bolt</i>
1	407 Bolt Pack - Sway Bar Drop
8	<i>3/8" USS washer</i>
4	<i>7/16"-14 x 1-1/4" bolt</i>
4	<i>7/16"-14 lock nut</i>

INSTALLATION INSTRUCTIONS

Important—measure before starting!

Measure from the center of the wheel up to the bottom edge of the wheel opening

LF _____ RF _____

LR _____ RR _____

» FRONT INSTALLATION

1. Park the vehicle on a clean, flat surface and block the rear wheels for safety.
2. Measure from the center of the wheel up to the bottom edge of the wheel opening and record below:

LF _____ RF _____

LR _____ RR _____
3. Raise the front of the vehicle and support with jack stands at each frame rail behind the lower control arms.
4. Remove the front wheels.
5. Models equipped with Electronic Power Assist Steering - disconnect the power steering control module connector to avoid arching of the contacts in the internal power relay from a hammer blow or impact wrench.
6. Remove the brake caliper anchor bracket bolts and remove the caliper from the knuckle **Figure 1**. Hang the caliper out of the way. Do not let the caliper hang by the brake hoses.
7. Disconnect the hub vacuum line from the hub. **Figure 1**



Figure 1

8. Remove the brake rotor and set aside.
9. Disconnect the ABS and hub vacuum lines from the retaining clips. Disconnect the brakeline bracket from the frame rail. Disconnect the ABS line from the inner fenderwell, and disconnect the clip **Figures 2 / 3**.

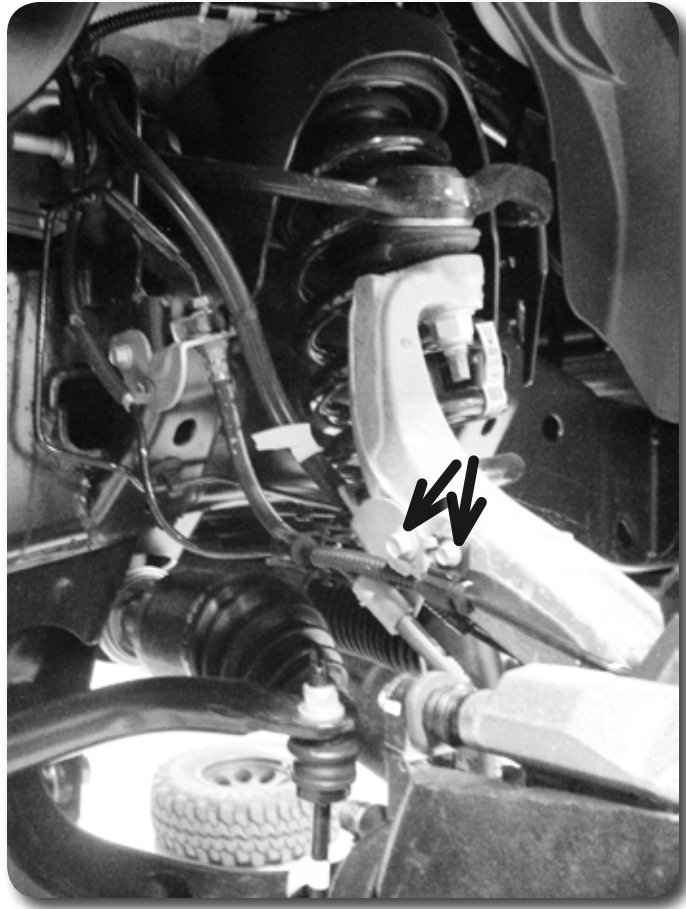

Figure 2



Figure 3

10. Disconnect the tie rod ends from the steering knuckles [Figure 4](#). Remove and retain the mounting nuts. Strike the steering knuckle near the tie rod end to dislodge the end. Take care not to strike the tie rod end.



Figure 4

11. Disconnect the sway bar links from the sway bar **Figure 5**. Retain hardware. The sway bar links do not need to be removed from the lower control arms.



Figure 5

12. Remove the four sway bar mounting nuts and remove the sway bar from the vehicle **Figure 6**. Retain hardware.



Figure 6

13. Carefully remove the hub dust cap to expose the axle shaft nut Figures 7/8. Remove the nut. Retain the cap and nut, they will be reinstalled later.

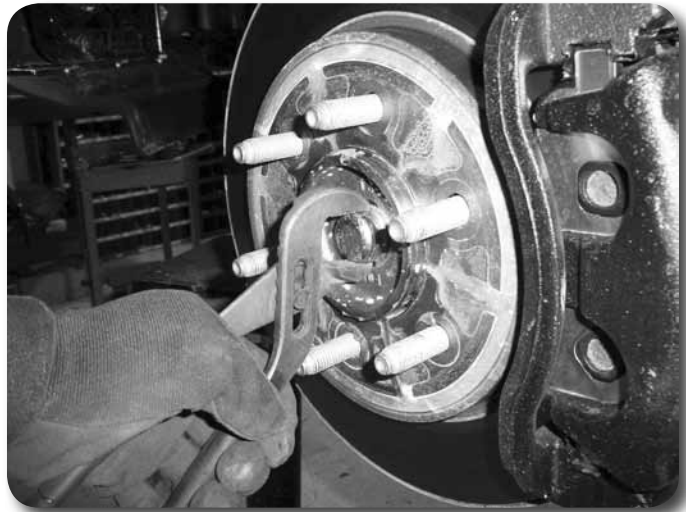

Figure 7



Figure 8

14. Loosen but do not remove the three strut assembly mounting nuts at the frame **Figure 9**. Do not loosen the middle strut nut.

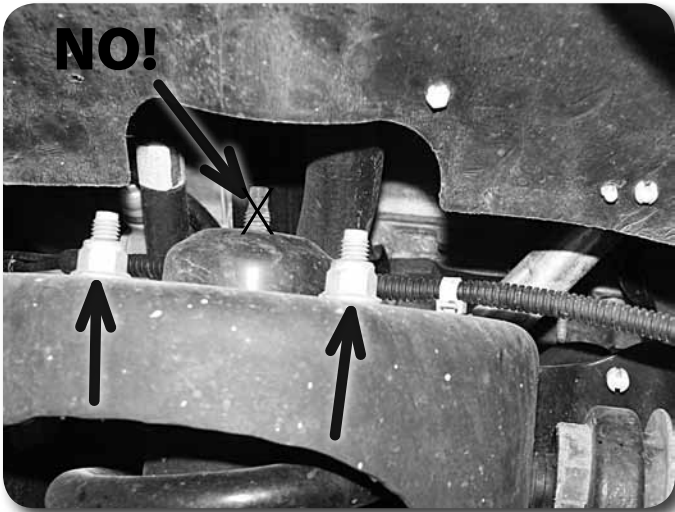

Figure 9

15. Loosen and remove the nut from the strut-to-lower control arm mounting bolt **Figure 10**. Leave the bolt in place at this time. Retain the mounting nut.

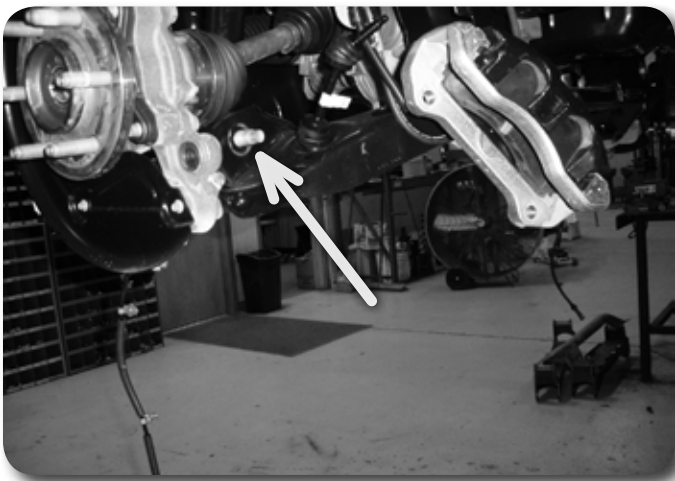

Figure 10

16. Remove the upper and lower ball joint nuts **Figure 11** and reinstall a few turns.

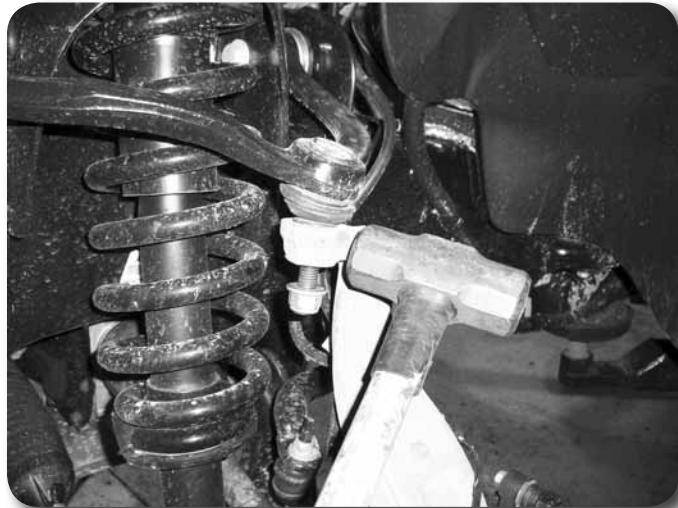

Figure 11

17. Strike the knuckle near the upper and lower ball joints to dislodge the joints from the knuckle.
18. Remove the upper ball joint and the strut-to-lower control arm bolt. Swing the knuckle/lower control arm down to remove the CV shaft from the hub. Retain ball joint nut and strut bolt.
19. Remove the lower ball joint nut and remove the knuckle from the vehicle. Retain hardware.
20. Remove the lower control arm mounting bolts and remove the lower control arm from the vehicle. Retain hardware.
21. Mark the struts to distinguish between driver's and passenger's.
22. Remove the three strut assembly mounting nuts at the frame and remove the strut assembly from the vehicle.
23. Remove the driveshaft mounting bolts and disconnect the driveshaft from the differential **Figure 12**. Allow the driveshaft to rest out of the way.



Figure 12

24. Remove the passenger's side CV shaft. Strike the shaft with a hammer to dislodge it from the splines. This will make handling the differential much easier. **Figure 13**



Figure 13

25. Support the front differential with an appropriate jack. Loosen all of the hardware and slide the differential all the way to the passenger's side. Orientate the joint at the steering rack so there is the most possible clearance to remove the front driver's side bolt. Remove this bolt first. Disconnect the differential breather hose from the differential housing. Remove the rear driver's side and one passenger's side differential mounting bolts [Figure 14 / 15 / 16](#) and remove the differential from the vehicle.

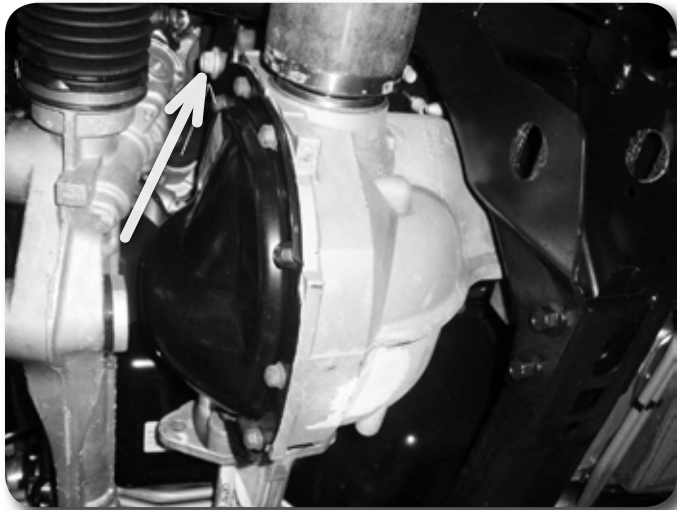

Figure 14

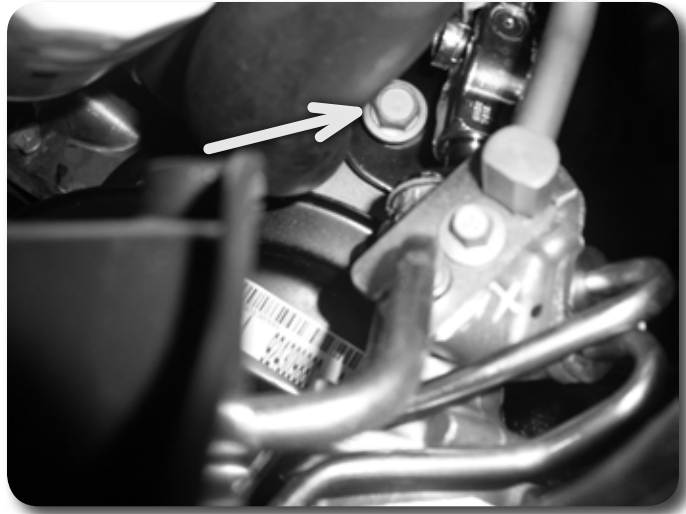

Figure 15

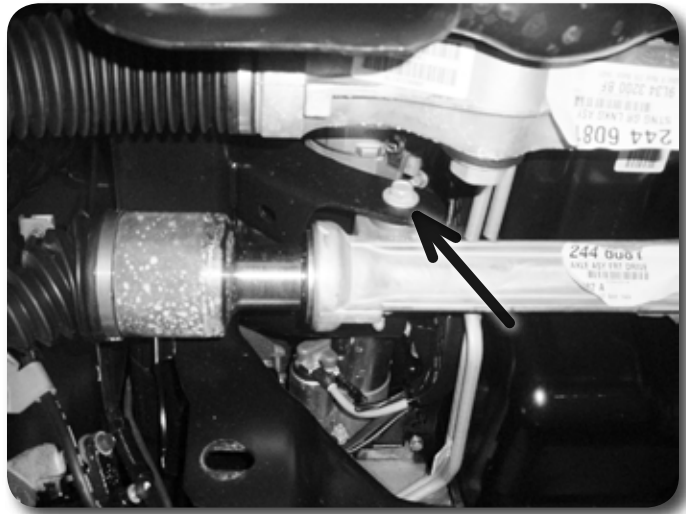

Figure 16

26. The driver's side rear lower control arm frame pocket must be modified to provide clearance for the differential in its relocated position. On the front side measure from the inside edge of the factory control arm slot $\frac{5}{8}$ " Figure 17. Make a vertical cut line at the mark. Measure down $1\frac{3}{4}$ " from the center of the slot, make a horizontal cut line.

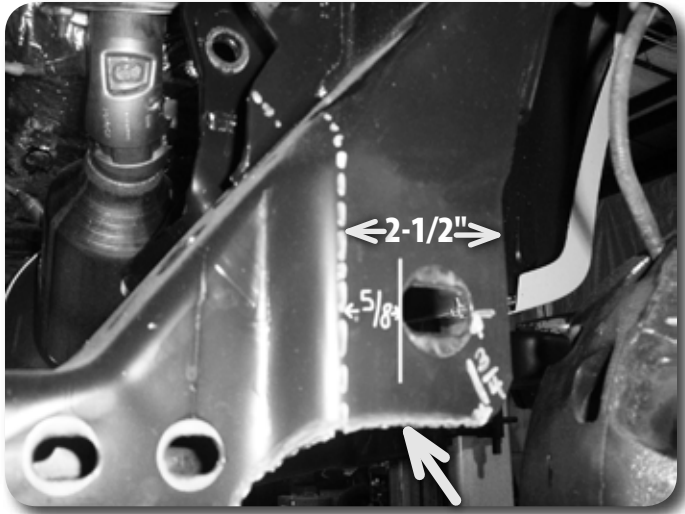

Figure 17

27. On the back side measure from the outside edge of the control arm slot 4-1/2" and mark Figure 18. Make a vertical cut line at the mark.

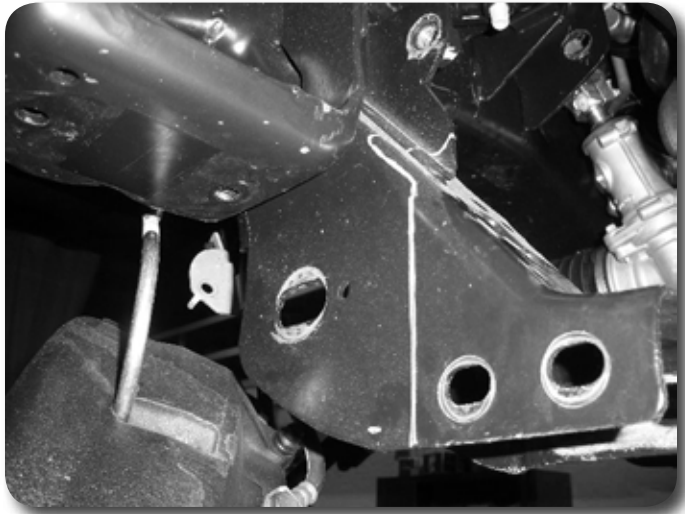

Figure 18

28. On the 'inside' face, measure up 3/4" from the bottom of the original diff mount bracket. Draw a horizontal line to the front and rear face. Figures 19
29. Trim the area from the vehicle.

Figure 18 Note:

Measure in 5/8" from inside of slot edge.

Measure down 1-3/4" from the center of the slot and make a horizontal line.

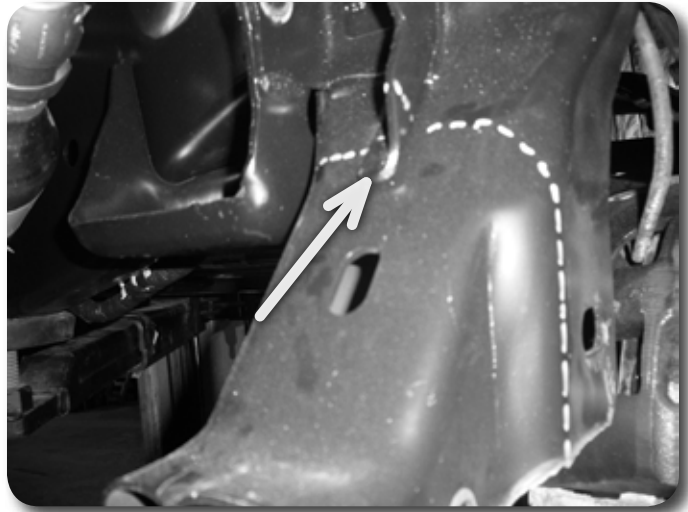

Figure 19

Figure 20 Note:

Measure up 3/4" from the edge as shown.

30. The passenger's side control arm pocket must also be trimmed. Measure down 1-3/4" and make a horizontal cut line. The cut will stop where the vertical offset begins, taper the cut as shown. Figure 20

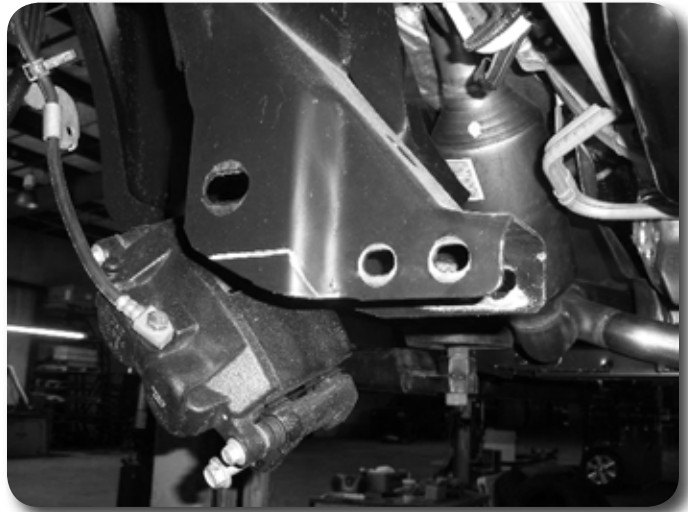

Figure 20

31. Install the rear crossmember Figure 21

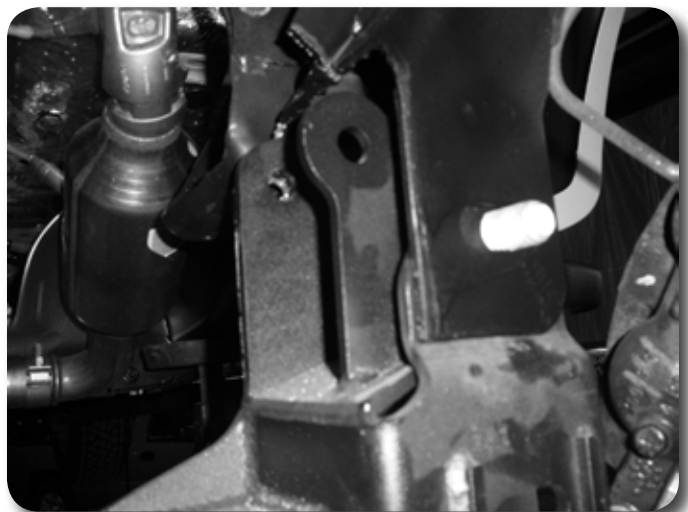

Figure 21

32. With the crossmember installed mark the differential hole on the factory control arm bracket. Remove the crossmember and drill a 5/8" hole at the mark, for easiest access drill the hole from front to back. **Figure 22**



Figure 22

Step 32 Note:

Drill hole from front to rear.

33. Install the passenger side and front driver side differential brackets onto the differential, run the provided 9/16" hardware from front to rear for clearance to the steering rack.
34. Loosely install the new differential drop brackets in the passenger's side and front driver's side factory differential mounting locations with the factory hardware. The brackets should offset toward the front of the vehicle when properly installed.
35. Raise the differential in the vehicle by aligning the OE differential mounts to the two front drop brackets. Attach the brackets to the frame with the OE hardware. **Figure 23**

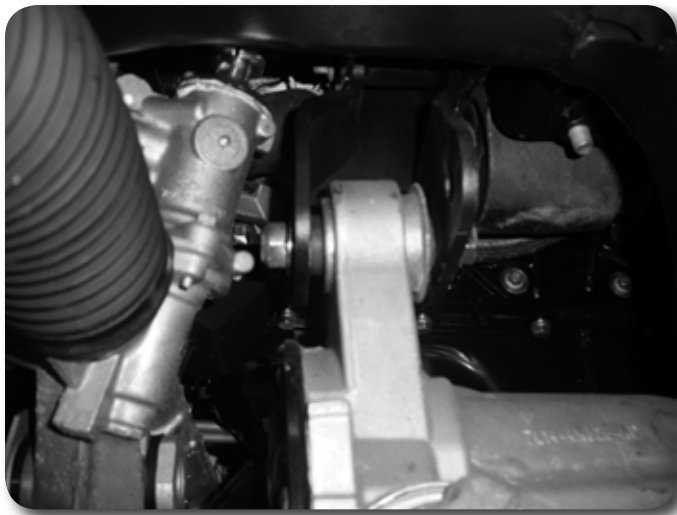

Figure 23

Step 33 Note:

Differential bracket hardware is located in bolt pack 781

The driver's side front bolt is 9/16" x 3-3/4"

36. Install the new rear crossmember in the rear lower control arm frame pockets and fasten with new 18mm bolts and washers (do not put nuts on at this time). Run bolts from front to rear. Leave hardware loose. Ensure the hole that was drilled in the frame pocket lines up to the differential mounting hole in the bracket. **Figure 24**

Figure 25 Note:

Run driver's side front diff bolt from front to rear. The driver's side rear bolt is 9/16" x4". (BP #781)

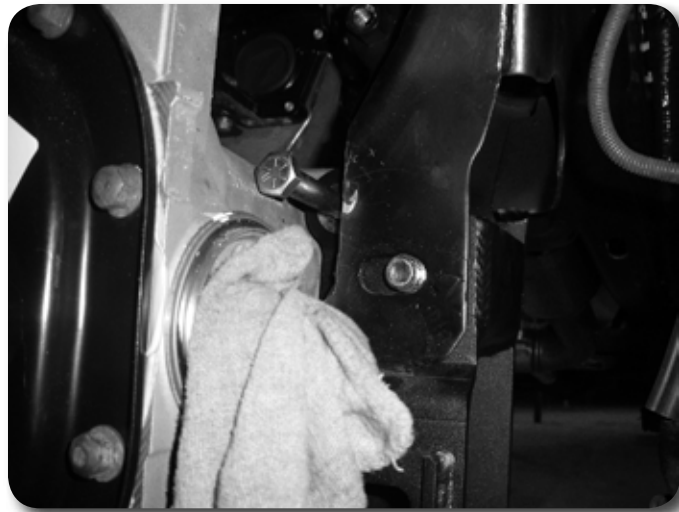

Figure 24

37. Fasten the differential to the rear crossmember Figure 25 with a 9/16" bolt, washers, and nut. Run the bolt from front to rear. Leave hardware loose.

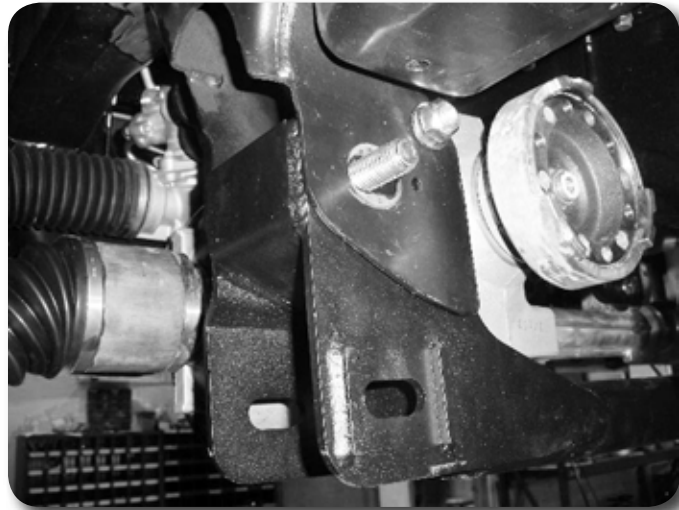

Figure 25

38. Install the offset differential support bracket to the passenger's side differential bracket using 9/16" hardware and 1/2" x 3" hardware to the crossmember. The horizontal slots will be located up at the differential. Leave hardware loose.

Figure 26

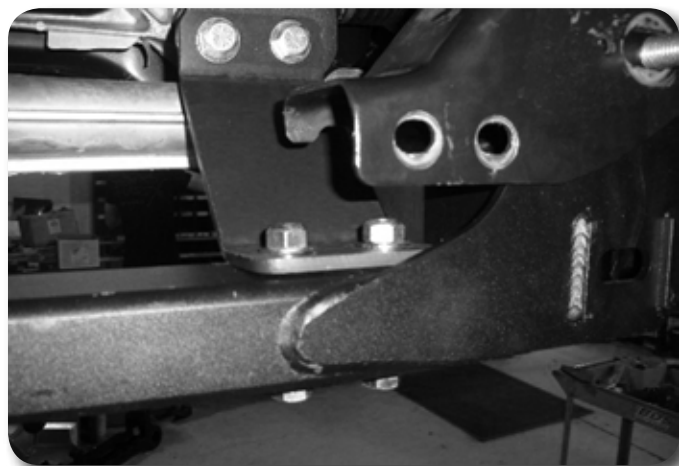

Figure 26

Figure 27 Note:

Passenger's side differential drop bracket hardware is located in BP #781.

39. Go back and torque all the differential mounting hardware (9/16" and 14mm) to 95 ft-lbs (6 bolts total). Remove the elbow from the vent line and attach the differential hose extension to the line and to the differential.
40. Install the front crossmember in the front lower control arm pockets and fasten with the OE lower control arm hardware. Leave hardware loose.
41. Install the lower control arms in the new crossmembers and fasten with the provided 18mm cam bolts, cam washers and 18mm nuts. Run the front bolts from front to rear and leave loose. Run the rear bolts from rear to front. The main body of the cam will be 'up' in the cam slot
42. Install the provided differential skid plate to the front and rear crossmembers with 1/2" x 1-1/4" bolts and 1/2" SAE washers into the threaded holes in the crossmembers **Figure 27**. Leave hardware loose.



Figure 27

Figure 28 Note:

1/2" x 1-1/4" bolts with washers - use loc-tite on threads. (BP #781)

43. Install the sway bar drop brackets with new 3/8" x 1-1/4" hardware, snug but do not tighten at this time. Attach the crossmember 18mm nut with 3/4" USS washer. Note: Use a ratchet extension through the lower slots to access the hardware **Figures 28**



Figure 28

Figure 29 Note:

Install 3/8" x 1-F" hardware into sway bar drop brackets. (BP #781)
Run the bolts from bottom - up.

44. With the lower control arms installed, go back and torque the four crossmember mounting bolts to 222 ft-lbs. Ensure that the front crossmember is centered in

the vehicle. Torque the differential skid plate bolts to 65 ft-lbs. Tighten sway bar drop hardware to 35 ft-lbs.

45. Place the upper strut spacers on top of the factory struts with factory hardware. Tighten the factory nuts to 40 ft-lbs.
46. Loosely install the strut assembly with new 7/16" nuts and washers on top of the frame strut mount. **Figure 29**



Figure 29

47. Reinstall the passengers side CV.
48. Remove the four hub bolts from the knuckle and remove the hub from the knuckle **Figure 30**. Inspect mounting surface of the hub assembly and clean any dirt or corrosion off as necessary.

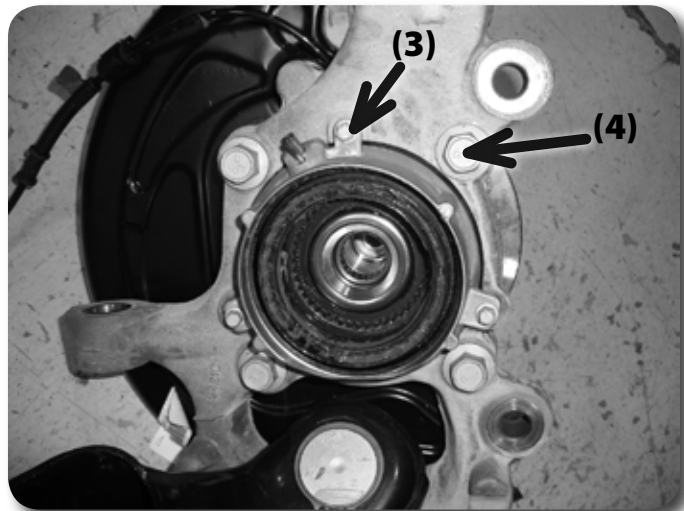

Figure 30

49. Install the hub into the corresponding new knuckle and fasten with the factory bolts. The ABS wire will be located at the 'top' of the hub. Use Loctite on the bolt threads and torque to 148 ft-lbs.
50. Remove the three 6mm bolts mounting the vacuum hub assembly to the inside of the factory knuckle **Figure 31**. Transfer the vacuum assembly over to the new knuckle. Make sure the vacuum port is pointing towards the top. Attach with the factory bolts, tighten bolts securely (about 5-7 ft-lbs).

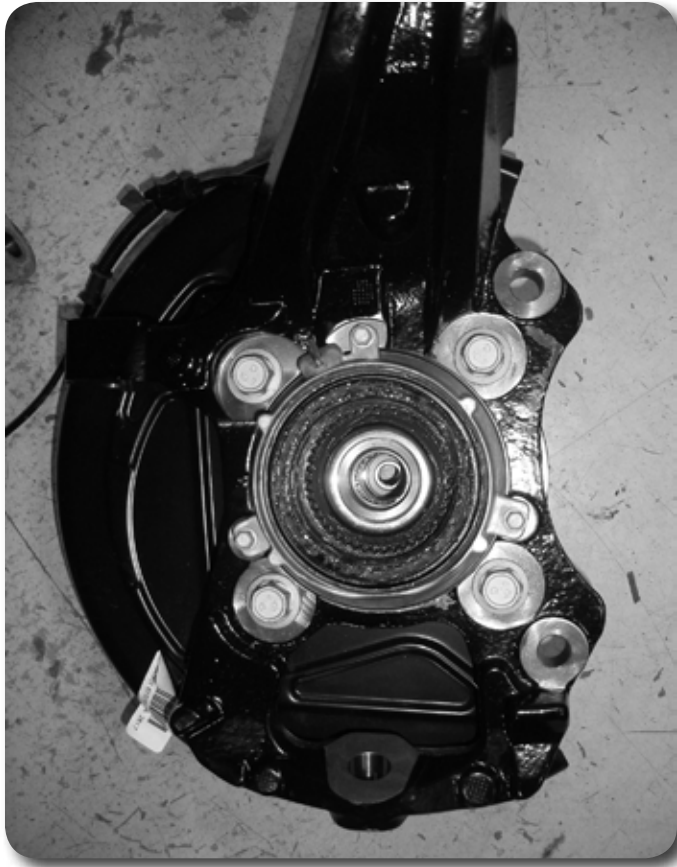

Figure 31

51. Install the dust shield with the factory 6mm bolts, tighten bolts securely (about 5-7 ft-lbs). Route the ABS cable behind the dust shield.
52. Install the new knuckle assembly on the lower control arm ball joint and loosely fasten with the original nut. Install the CV shaft in the hub, swing the whole assembly up and attach the lower control arm to the strut with the original hardware. Leave all hardware loose.
53. Attach the upper control arm to the knuckle with the original nut. Torque the upper ball joint to 85 ft-lbs and the lower ball joint to 111 ft-lbs.
54. Torque the upper strut nuts to 50 ft-lbs. Torque the lower strut bolts to 80 ft-lbs.
55. Fasten the CV shaft to the hub with the original nut. Make sure the splines are engaged properly in the vacuum actuated section of the hub. The hub should have a very minor amount of rotational play with the CV shaft if installed properly, torque to 20 ft-lbs. Reinstall the dust cap.
56. Install tie rod from top-down. Torque to 111 ft-lbs.
57. Install the brake rotor and caliper to the knuckle with OE bolts. Torque to 148 ft-lbs.
58. Install the brake line relocation brackets at the frame. Attach with factory hardware to frame, attach brakeline retaining clip with 1/4" nut and washer to the relocation bracket. Tighten to 15 ft-lbs. **Figures 32**

Figure 33 Note:

1/4" nut and washer is located in bolt pack 781.



Figure 32

59. Attach the ABS line to the connector at the inner fender and the vacuum line to the hub. Route the lines similar to the factory setup down to the side of the knuckle. Attach the ABS wire with the factory 6mm bolt to the side of the knuckle. Attach the brakeline with a new 6mm x 18mm bolt with 1/4" washer to the side of the knuckle, the brakeline locating tab will go into the unthreaded hole. Figures 33

Figure 34 Note:

New 6mm bolt and washer (BP #781) is used to attach the metal brakeline bracket to the steering knuckle.

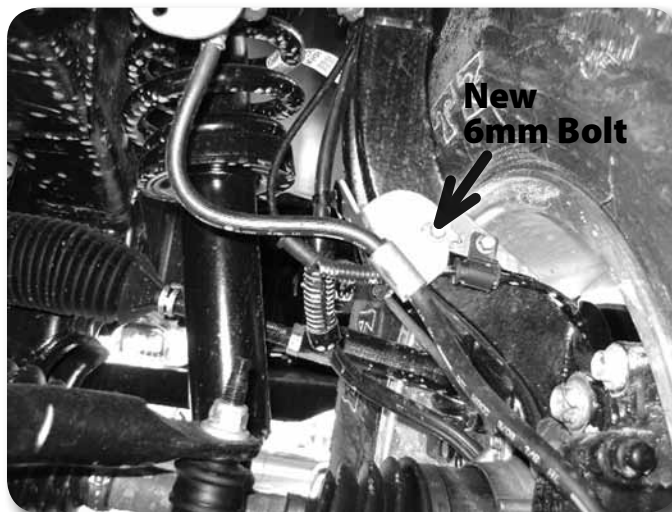

Figure 33

60. Install the sway bar to the new sway bar drop brackets with 7/16" x 1-1/4" hardware. Attach the sway bar to the sway bar end links with the original hardware. Torque the 7/16" hardware to 45 ft-lbs. Torque sway bar link nut to 45 ft-lbs.
61. Install the supplied driveshaft spacer and reattach front driveshaft to differential with new hardware. Torque bolts to 76 ft-lbs. Figure 34

Step 60 Note:

Sway bar mounting hardware is in BP #407

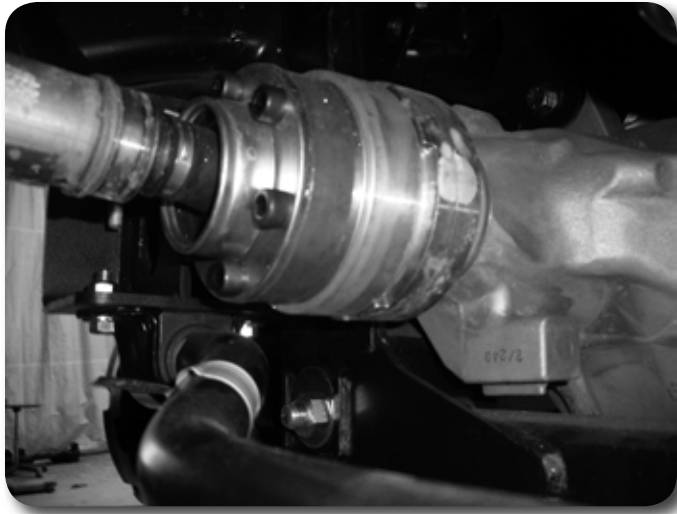

Figure 34

Figure 36 Note:

10mm allen head bolts located in BP #925 - use loc-tite on threads

62. Install the wheels and lower the vehicle to the ground.
63. Bounce the front of the vehicle to settle the suspension. Center the lower control arm cams and torque to 150 ft-lbs. Adjust the toe before driving it to an alignment shop.
64. Check all hardware for proper torque.

» **REAR INSTALLATION**

1. Block the front wheels and raise the rear of the vehicle. Place jack stands under the frame rails ahead of the spring hangers.
2. Remove the wheels.
3. The parking brake cable must be relocated. To disconnect the cable from the frame first pull down on the cable and clamp it off with vise grips near the middle of the frame **Figure 1**. This will gain slack to disconnect the driver's side rear cable from the main (passenger's side) cable.



Figure 1

Remove the driver's side parking brake cable from the junction bracket. **Figure 2**



Figure 2

4. Compress the retaining tabs and remove the driver's side cable from the spring hanger Figure 3. It will be relocated and reconnected later.

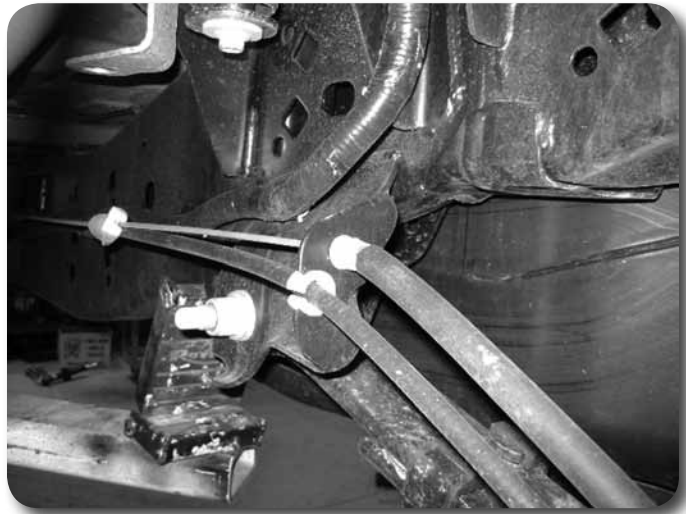

Figure 3

5. Disconnect the rear brake line from the frame. Figure 4

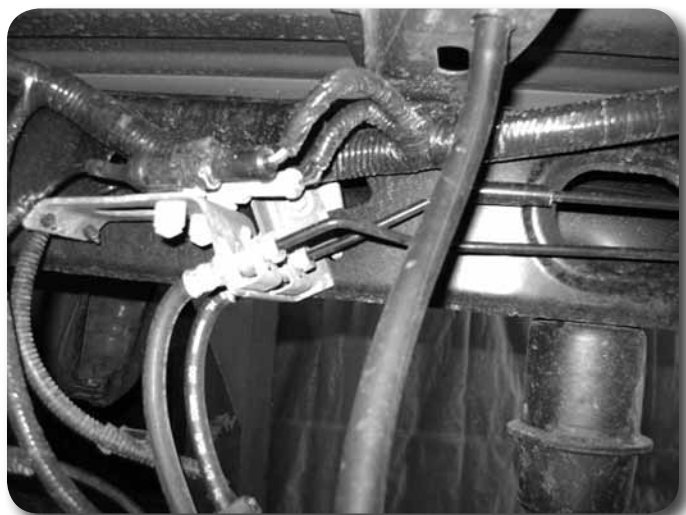

Figure 4

6. Support the rear axle with a hydraulic jack. Remove the factory shocks. Retain mounting hardware.

Note: Perform the rear installation on one side at a time.

7. Remove the passenger's side u-bolts.
8. Lower the axle and remove the factory lift block, it will not be reused.
9. For 5" rear block kits follow steps 11-14. 4" kits, skip ahead to step 15
10. Using C-clamps, clamp the leaf spring pack together on each side of the center pins. Remove the center pins and discard.
11. Place the plate on the bottom of the leaf pack and secure with new center pin in the 'forward' hole and flat head allen bolt through the 'rear' hole. Install new u-bolt retaining plate on top, it will be offset 'forward'. Tighten to 35 ft-lbs.

Figures 5 / 6 / 7

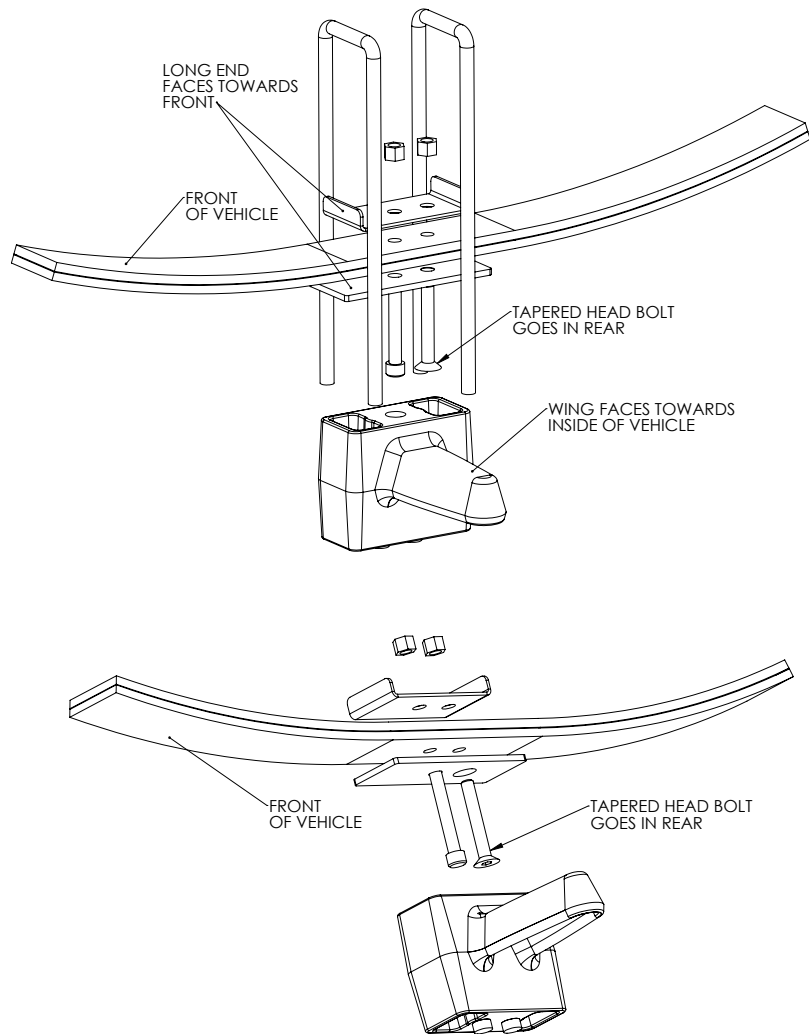

Figure 5

Figure 5 Note:

Flat head allen bolt is located in BP #774.



Figure 6

Figure 6 Note:

Trim excess from centerpin and flat head allen bolt.

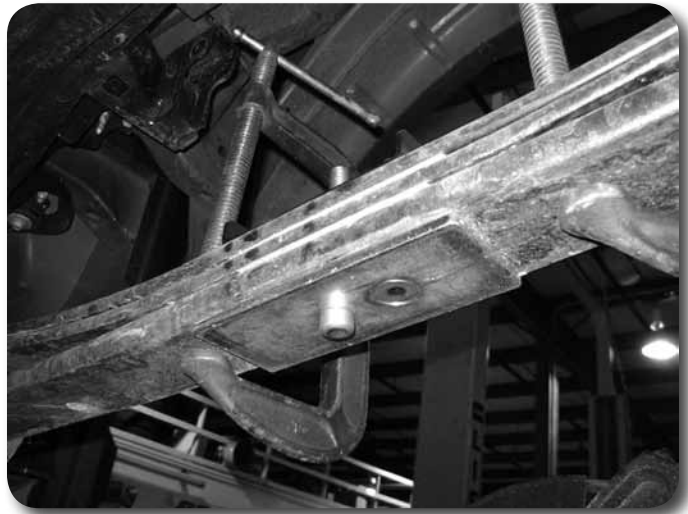

Figure 7

12. Install the new provided lift block so that the bump stop wing goes toward the inside of the vehicle. The block will use the both of the lower center pin holes. The upper only uses 1 hole which will shift the axle slightly forward.
13. Raise the axle/block to the spring while aligning the center pin. Fasten the spring/block assembly with the provided u-bolts, high nuts and washers. Snug u-bolts, they will be torque with the weight of the vehicle on the springs. **Figure 8**

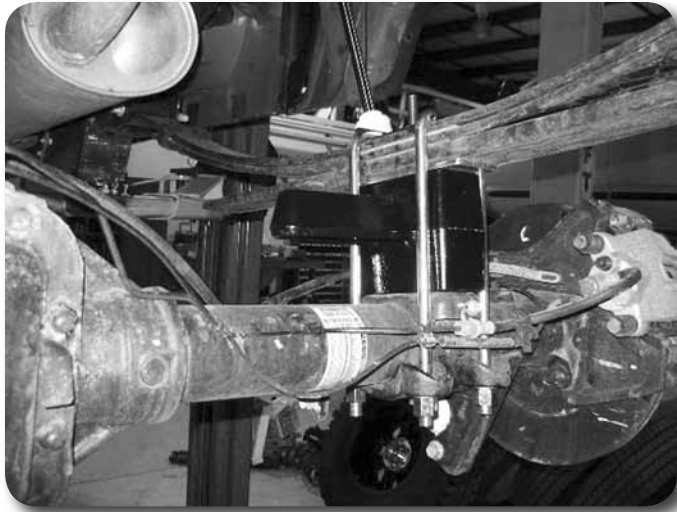

Figure 8

14. Install the new bump stop as shown **Figure 9**. The gusset on the wing will face towards the front of the vehicle. The part # is stamped on the bump stop wing. Part # 02429 = Driver's side, #02430 = Pass side.

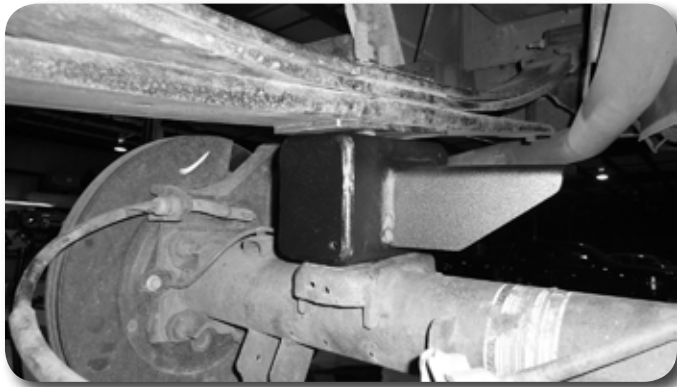

Figure 9

15. Raise the axle and align the center pins. Fasten the assembly with new u-bolts, high nuts, and washers. Snug - ubolts, do not tighten at this time. They will be tightened with the weight of the vehicle on the springs.
16. Repeat installation procedure on the driver's side of the vehicle.
17. Install the provided parking brake relocation bracket to the driver's side front spring hanger using 7/16" bolts, washers, and nuts. **Figure 10**
18. Reconnect the parking brake cable at the junction. When reconnected, remove the clamp to allow the cable to return to its normal tension. Attach the parking brake cable through the relocation bracket through the slot in the bottom. Models with Ford's electric retracting steps will need to order an extra relocation bracket, available separately. The steps can be temporarily disabled until the new bracket is installed. Feature is controlled in the instrument cluster computer.

Step 21 Note

Hardware for e-brake relocation bracket is located in bolt pack 774.



Figure 10

19. Install the provided brake line relocation bracket to the driver's side frame rail with the factory brake line bracket bolt Figure 11. Torque to 15 ft-lbs.



Figure 11

Post-Installation Warnings

1. Check all fasteners for proper torque. Check to ensure for adequate clearance between all rotating, mobile, fixed, and heated members. Verify clearance between exhaust and brake lines, fuel lines, fuel tank, floor boards and wiring harness. Check steering gear for clearance. Test and inspect brake system.
2. Perform steering sweep to ensure front brake hoses have adequate slack and do not contact any rotating, mobile or heated members. Inspect rear brake hoses at full extension for adequate slack. Failure to perform hose check/ replacement may result in component failure.
3. Perform head light check and adjustment.
4. Re-torque all fasteners after 500 miles. Always inspect fasteners and components during routine servicing.

20. Attach the brake line to the relocation bracket with a 1/4" nut and 1/4" USS washer. It may be necessary to rotate the OE brakeline clip bracket to have the lines face 'down' for adequate slack. Torque to 15 ft-lbs.
21. Install the new shocks with the OE hardware. Torque to 60 ft-lbs.
22. Check all lines/wires for proper slack.
23. If the vehicle is equipped with EPAS, reconnect the power steering control module connector.
24. Install the wheels and lower the vehicle to the ground.
25. Bounce the rear of the vehicle to settle the suspension.
26. Torque the u-bolts to 100-120 ft-lbs.
27. Check all hardware for proper torque
28. Check hardware after 500 miles.
29. A complete front end alignment is necessary.
30. Adjust headlights.