



## F2614 Installation Instructions 2009-14 Ford F-150 2WD 6" Suspension System

### Read and understand all instructions and warnings prior to installation of product and operation of vehicle.

Zone Offroad Products recommends this system be installed by a professional technician. In addition to these instructions, professional knowledge of disassembly/ reassembly procedures and post installation checks must be known. Minimum tool requirements include the following: Assorted metric and standard wrenches, hammer, hydraulic floor jack and a set of jack stands. See the "Special Tools Required" section for additional tools needed to complete this installation properly and safely.

#### » PRODUCT SAFETY WARNING

Certain Zone Suspension Products are intended to improve off-road performance. Modifying your vehicle for off-road use may result in the vehicle handling differently than a factory equipped vehicle. Extreme care must be used to prevent loss of control or vehicle rollover. Failure to drive your modified vehicle safely may result in serious injury or death. Zone Offroad Products does not recommend the combined use of suspension lifts, body lifts, or other lifting devices.

You should never operate your modified vehicle under the influence of alcohol or drugs. Always drive your modified vehicle at reduced speeds to ensure your ability to control your vehicle under all driving conditions. Always wear your seat belt.

#### » TECHNICAL SUPPORT

*Live Chat* provides instant communication with Zone tech support. Anyone can access live chat through a link on [www.zoneoffroad.com](http://www.zoneoffroad.com).

[www.zoneoffroad.com](http://www.zoneoffroad.com) may have additional information about this product including the latest instructions, videos, photos, etc.

Send an e-mail to [tech@zoneoffroad.com](mailto:tech@zoneoffroad.com) detailing your issue for a quick response.

**888.998.ZONE** Call to speak directly with Zone tech support.

#### » PRE-INSTALLATION NOTES

1. Special literature required: OE Service Manual for model/year of vehicle. Refer to manual for proper disassembly/reassembly procedures of OE and related components.
2. Adhere to recommendations when replacement fasteners, retainers and keepers are called out in the OE manual.
3. Larger rim and tire combinations may increase leverage on suspension, steering, and related components. When selecting combinations larger than OE, consider the additional stress you could be inducing on the OE and related components.
4. Post suspension system vehicles may experience drive line vibrations. Angles may require tuning, slider on shaft may require replacement, shafts may need to be lengthened or trued, and U-joints may need to be replaced.
5. Secure and properly block vehicle prior to installation of Zone Offroad Products. Always wear safety glasses when using power tools.
6. If installation is to be performed without a hoist, Zone Offroad Products recommends rear alterations first.
7. Due to payload options and initial ride height variances, the amount of lift is a base figure. Final ride height dimensions may vary in accordance to original vehicle attitude. Always measure the attitude prior to beginning installation.

#### Difficulty Level

easy 1 2 3 **4** 5 difficult

Estimated installation: 6-8 hours

#### Tire/Wheel Fitment

37x12.50x18 w/ 5" Backspacing

35x13.50x18 w/ 5" Backspacing

35x12.50x18 w/ 4.5" Backspacing

37x12.50x20 w/ 5-5.5" Backspacing

35x13.50x20 w/ 5-5.5" Backspacing

35x12.50x20 w/ 4.5" Backspacing

17" wheels will not fit after installation. Stock 20's can be reinstalled with stock tires only

## Kit Contents

### F2615 Box Kit

Qty	Part
1	Steering Knuckle (Drv)

### F2616 Box Kit

Qty	Part
1	Steering Knuckle (Pass)

### F2614 Box Kit

Qty	Part
1	Front Crossmember
1	Rear Crossmember
2	Sway Bar Drop
2	Brake Line Drop Bracket
8	Cam Washer
2	Front Cam Bolt
2	Rear Cam Bolt
4	18mm Cam Bolt Nut
2	Crossmember Support
1	Bolt Pack 773 - Main
2	18mm-2.50 x 150mm bolt
4	3/4" SAE Washer
2	18mm-2.50 Prevailing torque nut
2	1/4"-20 prevailing torque nut
4	1/4" USS flat washer
2	6mm-1.00 x 18mm bolt
4	1/2"-13 x 1-1/4" button head bolt
4	1/2" SAE Washer
4	3/8"-16 x 1-1/4" bolt
8	3/8" SAE Thru hardened Washer
4	3/8"-16 Prevailing torque nut
1	Bolt Pack 407 - Sway Bar Drop
8	3/8" USS washer
4	7/16"-14 x 1-1/4" bolt
4	7/16"-14 prevailing torque nut

### F2619 Box Kit

2	5" Offset Rear Block
1	E-brake Bracket
2	Lower Offset Center Pin Plate
2	Upper U-bolt Retaining Plate
4	9/16" x 3-1/8" x 15" Square U-bolt
1	Offset Brake Line Drop Bracket
8	9/16" High Nut
8	9/16" SAE Washer
2	1/2" x 4" center pin
1	Bolt Pack 768 - Rear Brake Line Relocation
2	1/4"-20 x 3/4" bolt
2	1/4"-20 nylock nut
4	1/4" USS flat washer
1	Bolt Pack 774 - Rear Block Kit
2	1/2"-20 x 3-1/2" bolt
2	1/2"-20 nut
2	7/16"-14 x 1-1/4" bolt
4	7/16" SAE washer
2	7/16"-14 Prevailing torque nut
1	1/4"-20 prevailing torque nut
1	1/4" USS washer

### F2690 Box Kit (2009-13 6" Only)

2	6" Replacement Strut
2	12mm-1.75 Flange Nut
2	Strut Coil Seat Pack

### F2624 Box Kit (2014 6" Only)

2	6" Strut Spacer
2	Bolt Pack 769 - Strut spacers
6	7/16"-14 nylock nut
6	3/8 USS flat washer

# INSTALLATION INSTRUCTIONS

## » FRONT INSTALLATION

1. Park the vehicle on a clean, flat surface and block the rear wheels for safety.
2. Raise the front of the vehicle and support with jack stands at each frame rail behind the lower control arms.
3. Remove the front wheels.
4. 2011 and newer models equipped with EPAS (Electronic Power Assist Steering) disconnect the power steering control module connector to avoid arching of the contacts in the internal power relay from a hammer blow or impact wrench.
5. Remove the brake caliper anchor bracket bolts and remove the caliper from the knuckle **Figure 1**. Hang the caliper out of the way. Do not let the caliper hang by the brake hoses.

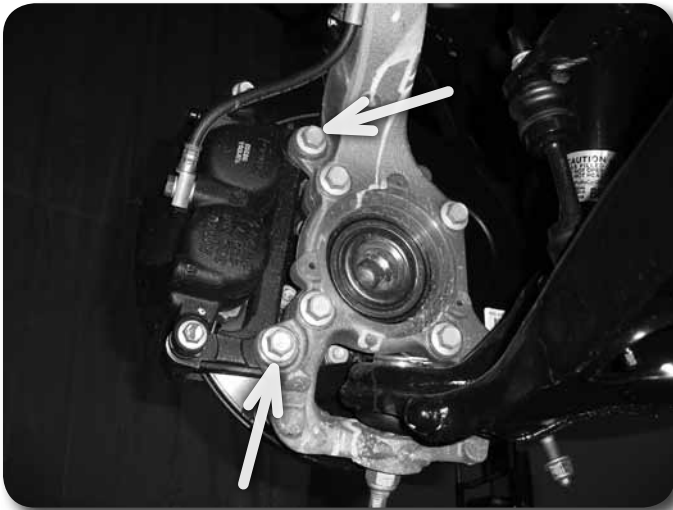

Figure 1

6. Remove the brake rotor and set aside.
7. Disconnect the ABS and hub vacuum lines from the retaining clips. Disconnect the brakeline bracket from the frame rail. Disconnect the ABS line from the inner fender well, and disconnect the clip **Figure 2A/B**.

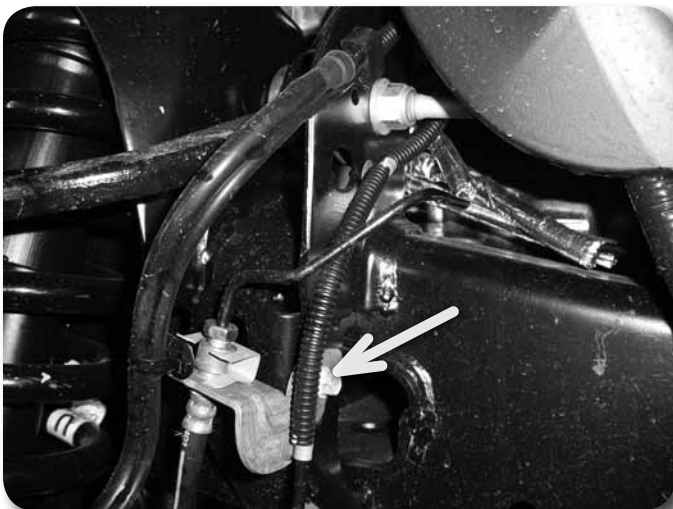

Figure 2A

### Important—measure before starting!

Measure from the center of the wheel up to the bottom edge of the wheel opening

LF \_\_\_\_\_ RF \_\_\_\_\_

LR \_\_\_\_\_ RR \_\_\_\_\_



Figure 2B

8. Disconnect the tie rod ends from the steering knuckles **Figure 3**. Remove and retain the mounting nuts. Strike the steering knuckle near the tie rod end to dislodge the end. Take care not to strike the tie rod end.



Figure 3

9. Remove the upper and lower ball joint nuts and reinstall a few turns.
10. Strike the knuckle near the upper and lower ball joints to dislodge the joints from the knuckle.
11. Remove the upper ball joint and lower ball joint nuts and remove the knuckle from the vehicle. Save ball joint nuts.
12. Disconnect the sway bar links from the sway bar **Figure 4**. Retain hardware. The sway bar links do not need to be removed from the lower control arms.



Figure 4 - 2009-13 Shown

13. Remove the four sway bar mounting nuts and remove the sway bar from the vehicle **Figure 5**. Retain hardware
14. Remove the strut-to-lower control arm mounting bolt on 2009-13 models. 2014 models: Remove the two bar pin bolts. Save hardware.



Figure 5

15. Remove the lower control arm mounting bolts **Figure 6** and remove the lower control arms from the vehicle. Save hardware.

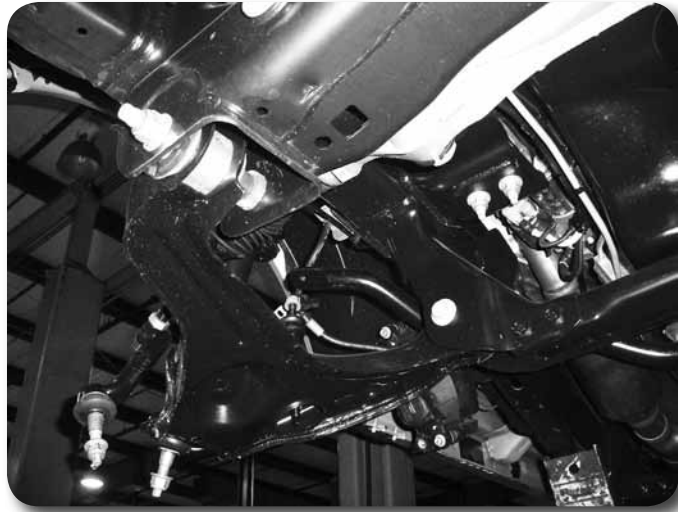

Figure 6

16. Mark the struts to distinguish between driver's and passenger's. In addition, mark the relationship between the coil and the lower strut mounting hole and finally the top plate and the rubber coil seat.
17. Remove the three strut assembly mounting nuts at the frame **Figure 7** and remove the struts from the vehicle. Do not loosen the middle strut nut.



Figure 7

### Step 18 Note

The offset portion of the crossmember ends go toward the front of the vehicle and the factory rear crossmember remains in place. Crossmember hardware is located in hardware pack #773.

18. The factory rear control arm pockets must also be trimmed to clear the new rear crossmember. Measure down 1-3/4" from the center of the factory control arm slot and make a horizontal cut line. The cut will stop where the vertical offset in the factory mount begins. **Figure 8**

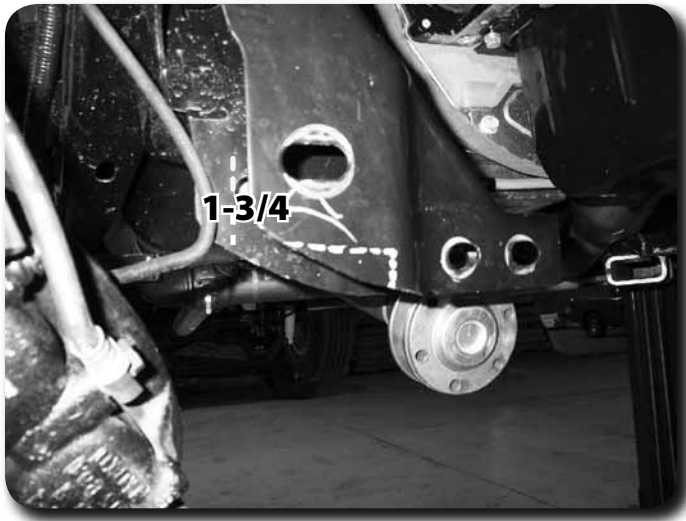

Figure 8

19. Install the new rear crossmember in the rear lower control arm frame pockets and fasten with new 18mm x 150mm bolts and washers. Do not put nuts on at this time. Run bolts from front to rear. Leave hardware loose. **Figure 9.**



Figure 9

20. Install the front crossmember in the front lower control arm pockets and fasten with the original lower control arm hardware **Figure 10**. Run bolts from front to rear. Leave hardware loose.
21. Install the lower control arms in the new crossmembers and fasten with the provided 18mm cam bolts, cam washers and 18mm nuts. Run the front bolts from front to rear and leave loose. Run the rear bolts from rear to front. The main body of the cam will be 'up' in the cam slot.
22. Install the sway bar drop brackets with new 3/8" x 1-1/4" bolts, washers and nuts. Run hardware from bottom - up, snug but do not tighten at this time. Attach the crossmember 18mm nut with 3/4" USS washer **.Figure 10, 11**

### **Step 21 Note**

Sway bar bracket hardware is located in hardware pack #407. Use a ratchet extension through the lower slots to access the hardware

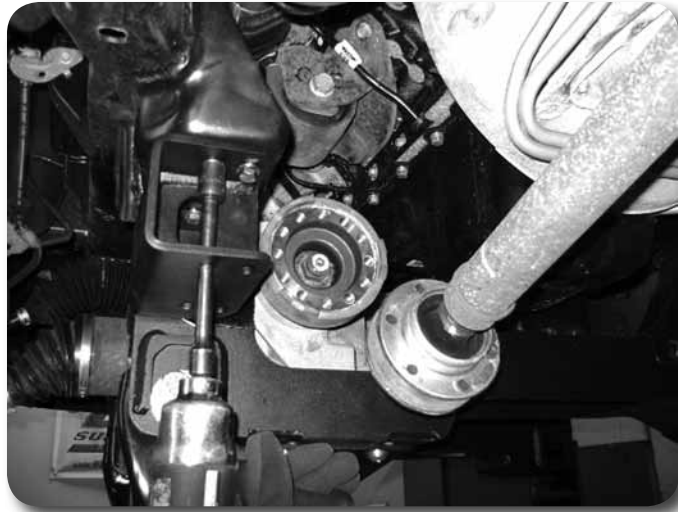

Figure 10

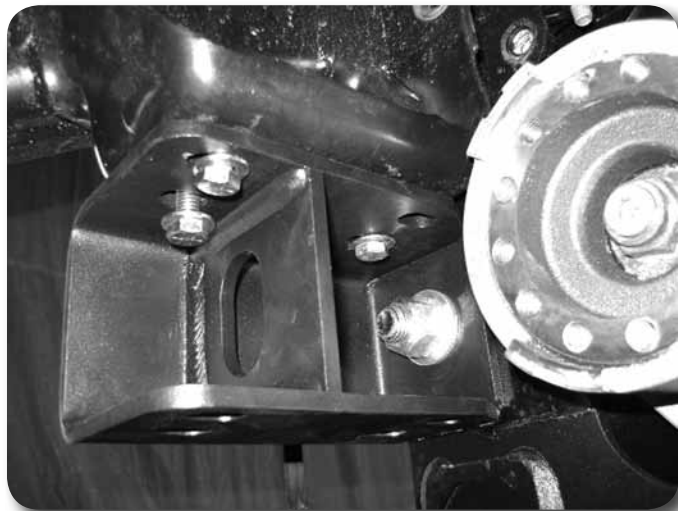

Figure 11

23. With the lower control arms installed, go back and torque the four crossmember mounting bolts to 222 ft-lbs. Ensure that the front crossmember is centered in the vehicle. Tighten sway bar drop hardware to 35 ft-lbs.

**2009-2013 models use steps 23-29, 2014 models use steps 30-31**

24. (2009-13 models) Place the strut assembly into a high quality spring compressor. Make alignment marks on the coil spring, strut and upper coil mount plate. These marks will help to align the assembly when the new strut is installed.

Figure 12a





Figure 12a

25. (2009-13 models) Compress the coil per the spring compressor instructions and remove the strut nut.
26. (2009-13 models) Remove the strut from the coil and top cap.
27. (2009-13 models) Locate the new struts. Turn the strut rod counterclockwise to release the rod and allow it to extend. Install the provided coil seat on the new struts.
28. (2009-13 models) Remove the factory bump stop from the original strut rod and install it on the new strut rod **Figure 12b**. Transfer any alignment marks made on the original strut to the new strut.



Figure 12b

### Step 31 Note

Strut Spacer hardware is located in bolt pack 769

29. (2009-13 models) Align marks on coil to the upper mount and also with the lower mounting hole. Install the new strut in the coils spring and factory top cap. Fasten the strut rod with the new provided 12mm flange nut. Torque strut rod nut to 40 ft-lbs.
30. (2009-13 models) Install the strut assemblies in the appropriate sides on the vehicle with factory frame hardware, leave hardware loose at this time. Skip to step 32
31. (2014 models) Place the provided strut spacer on each strut and attach with the factory hardware. Tighten to 40 ft-lbs. The strut spacer is the same for both sides.
32. (2014 models) Install the strut and spacer assembly into the vehicle. Attach the upper mount with the new 7/16" nuts and washers. Leave hardware loose at this time.



Figure 13

33. Raise the lower control arm and loosely fasten to the strut with the original hardware.
34. Remove the four hub bolts from the knuckle and remove the hub from the knuckle **Figure 14**. Inspect mounting surface of the hub assembly and clean any dirt or corrosion off as necessary.



Figure 14 - 4wd Shown, 2wd Similar

35. Install the hub into the corresponding new knuckle and fasten with the factory bolts. The ABS wire will be located at the 'top' of the hub. Use Loctite on the bolt threads and torque to 148 ft-lbs.
36. Remove the factory dust shields from the original knuckles and install them on the new knuckles with the factory 6mm bolts. Tighten bolts securely (about 5-7 ft-lbs). Route the ABS cable between the dust shield and the knuckle.
37. Install the new knuckle assembly on the lower control arm ball joint and loosely fasten with the original nut. Leave hardware loose.
38. Attach the upper control arm to the knuckle with the original nut. Torque the upper ball joint to 85 ft-lbs and the lower ball joint to 111 ft-lbs.
39. Torque the upper strut frame mount nuts to 35 ft-lbs. The lower bolt will be tightened later with the weight of the vehicle on the suspension.
40. Install the brake rotor and caliper to the knuckle with factory bolts. Torque to 148 ft-lbs. **Figure 15**

**Step 37 Note**  
Loosen the upper control arm to frame bolts to aid in attaching the upper balljoint if necessary.



Figure 15

41. Install the brake line relocation brackets at the frame **Figure 16**. Attach with factory hardware to frame, attach brakeline retaining clip with a provided 1/4" nut and washer to the relocation bracket. Tighten to 15 ft-lbs.

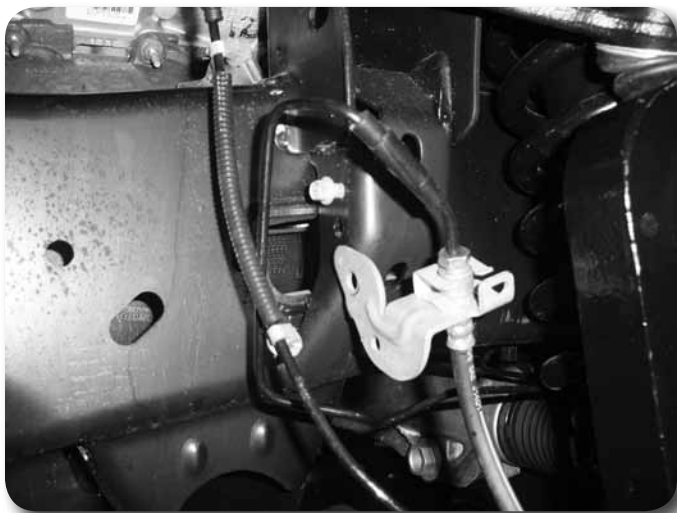

Figure 16

42. Attach the ABS line to the connector at the inner fender and the vacuum line to the hub. Route the lines similar to the factory setup down to the side of the knuckle. Attach the ABS wire with the factory 6mm bolt to the side of the knuckle. Attach the brakeline with a new 6mm x 18mm bolt with 1/4" washer to the side of the knuckle, the brakeline locating tab will go into the unthreaded hole. Figure 17.



Figure 17

43. Install the sway bar to the new sway bar drop brackets Figure 18 with provided 7/16" x 1-1/4" bolts, nuts and 7/16" SAE washers. Attach the sway bar to the sway bar end links with the original hardware. Torque the 7/16" hardware to 45 ft-lbs. Torque sway bar link nut to 45 ft-lbs.



Figure 18

44. Install tie rod ends to the knuckles from top-down. Torque to 111 ft-lbs.  
45. If equipped, re-connect EPAS control module connector.  
46. Install the wheels and lower the vehicle to the ground.  
47. Bounce the front of the vehicle to settle the suspension. 2009-13 models: Torque the lower strut mount bolt to 350 ft-lbs. 2014 models: Torque the lower strut mount bolts to 80 ft-lbs. Center the lower control arm cams and torque to 150 ft-lbs. Adjust the toe-in before driving it to an alignment shop.

48. Check all hardware for proper torque.

## Rear Installation

1. Block the front wheels and raise the rear of the vehicle. Place jack stands under the frame rails ahead of the spring hangers.
2. Remove the wheels.
3. The parking brake cable must be relocated. To disconnect the cable from the frame first pull down on the cable and clamp it off with vise grips near the middle of the frame **Figure 19**. This will gain slack to disconnect the driver's side rear cable from the main (passenger's side) cable.



Figure 19

4. Remove the driver's side parking brake cable from the junction bracket **Figure 20**.



Figure 20

5. Compress the retaining tabs and remove the driver's side cable from the spring hanger **Figure 21**. It will be relocated and reconnected later.

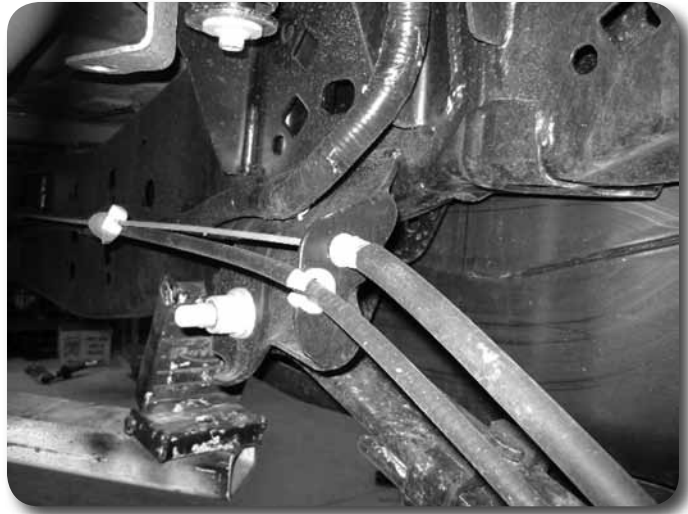

Figure 21

6. Disconnect the rear brake line from the frame. Figure 22

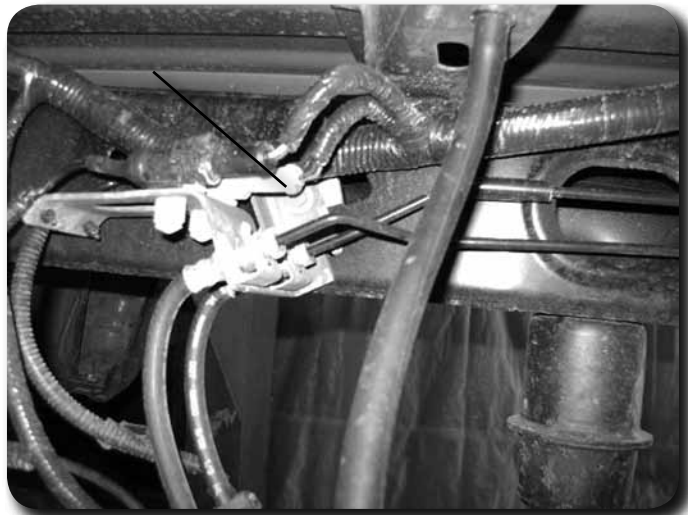

Figure 22

7. Support the rear axle with a hydraulic jack. Remove the factory shocks. Save mounting hardware.

*Perform the rear installation on one side at a time. All required hardware is located in hardware pack #774.*

8. Remove the passenger's side u-bolts.
9. Lower the axle and remove the factory lift block, it will not be reused.
10. Using C-clamps, clamp the leaf spring pack together on each side of the center pins. Remove the center pins and discard.
11. Place the plate on the bottom of the leaf pack and secure with new center pin in the 'forward' hole and flat head allen bolt through the 'rear' hole. Install new u-bolt retaining plate on top, it will be offset 'forward'. Tighten to 35 ft-lbs.

Figure 23,24,25

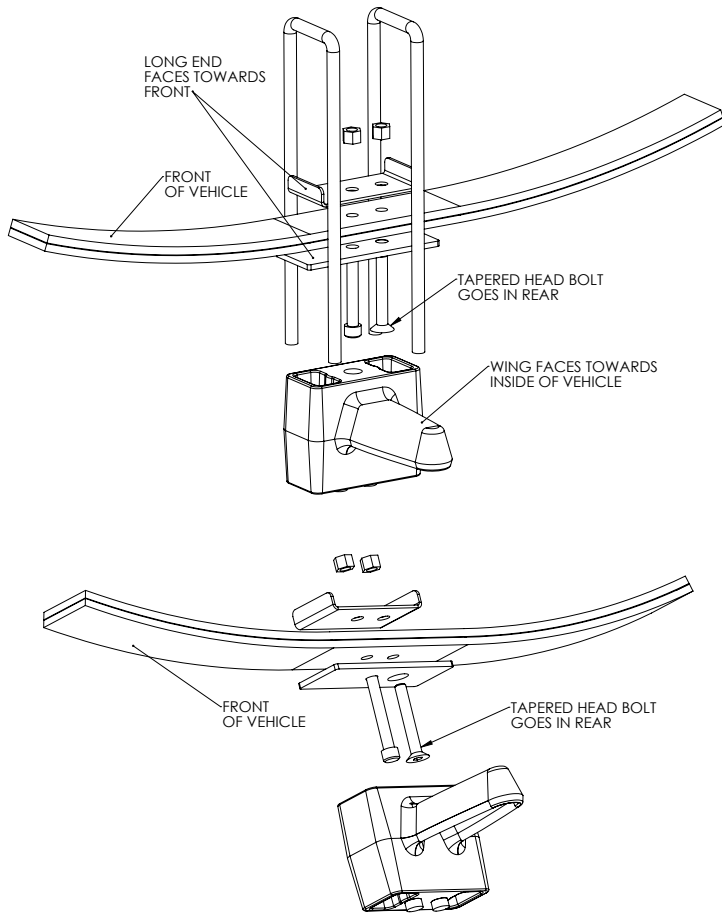

Figure 23



Figure 24

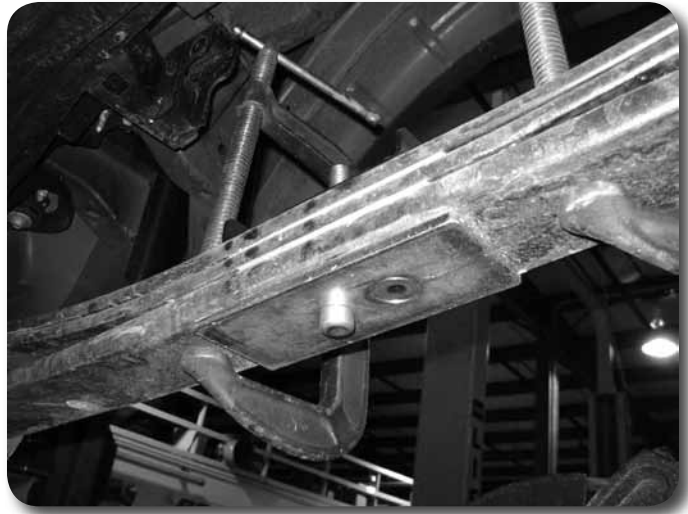

Figure 25

12. Install the new provided lift block so that the bump stop wing goes toward the inside of the vehicle. The block will use the both of the lower center pin holes. The upper only uses 1 hole which will shift the axle slightly forward.
13. Raise the axle/block to the spring while aligning the center pin. Fasten the spring/block assembly with the provided u-bolts, high nuts and washers. Snug u-bolts, they will be torque with the weight of the vehicle on the springs.

Figure 26

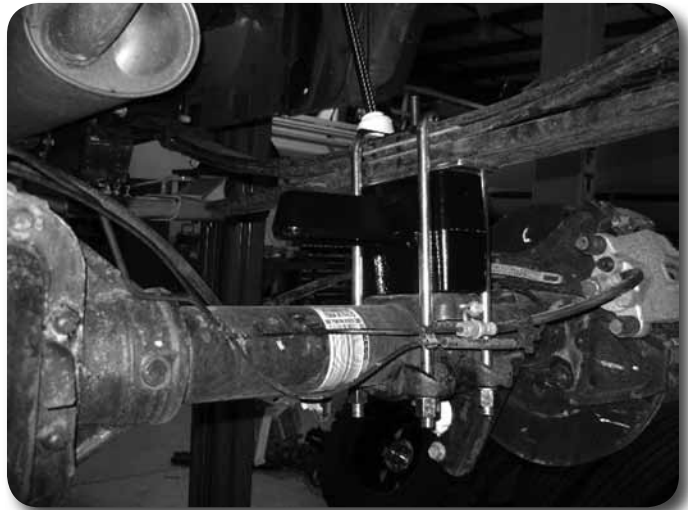

Figure 26

14. Repeat installation procedure on the driver's side of the vehicle.
15. Install the provided parking brake relocation bracket to the driver's side front spring hanger using provided 7/16" bolts, washers, and nuts. **Figure 27**
16. Reconnect the parking brake cable at the junction. When reconnected, remove the clamp to allow the cable to return to its normal tension. Attach the parking brake cable through the relocation bracket through the slot in the bottom **Figure 27**





Figure 27

17. Install the provided brake line relocation bracket to the driver's side frame rail with the factory brake line bracket bolt Figure 28. Torque to 15 ft-lbs.



Figure 28

18. Attach the brake line to the relocation bracket with a provided 1/4" nut and 1/4" USS washer. It may be necessary to rotate the factory brakeline clip bracket to have the lines face 'down' for adequate slack. Torque to 15 ft-lbs.
19. Install the provided new shocks with the factory hardware. Torque to 60 ft-lbs.
20. Check all lines/wires for proper slack.
21. Install the wheels and lower the vehicle to the ground.
22. Bounce the rear of the vehicle to settle the suspension.
23. Torque the u-bolts to 100-120 ft-lbs.
24. Check all hardware for proper torque
25. Check hardware after 500 miles.
26. A complete front end alignment is necessary.
27. Adjust headlights.

### Post-Installation Warnings

1. Check all fasteners for proper torque. Check to ensure for adequate clearance between all rotating, mobile, fixed, and heated members. Verify clearance between exhaust and brake lines, fuel lines, fuel tank, floor boards and wiring harness. Check steering gear for clearance. Test and inspect brake system.
2. Perform steering sweep to ensure front brake hoses have adequate slack and do not contact any rotating, mobile or heated members. Inspect rear brake hoses at full extension for adequate slack. Failure to perform hose check/ replacement may result in component failure.
3. Perform head light check and adjustment.
4. Re-torque all fasteners after 500 miles. Always inspect fasteners and components during routine servicing.