



#F1420 Installation Instructions 2011 Ford Super Duty F250/350 4wd 4" Suspension Lift

Read and understand all instructions and warnings prior to installation of product and operation of vehicle.

Zone Offroad Products recommends this system be installed by a professional technician. In addition to these instructions, professional knowledge of disassembly/ reassembly procedures and post installation checks must be known. Minimum tool requirements include the following: Assorted metric and standard wrenches, hammer, hydraulic floor jack and a set of jack stands. See the "Special Tools Required" section for additional tools needed to complete this installation properly and safely.

» PRODUCT SAFETY WARNING

Certain Zone Suspension Products are intended to improve off-road performance. Modifying your vehicle for off-road use may result in the vehicle handling differently than a factory equipped vehicle. Extreme care must be used to prevent loss of control or vehicle rollover. Failure to drive your modified vehicle safely may result in serious injury or death. Zone Offroad Products does not recommend the combined use of suspension lifts, body lifts, or other lifting devices.

You should never operate your modified vehicle under the influence of alcohol or drugs. Always drive your modified vehicle at reduced speeds to ensure your ability to control your vehicle under all driving conditions. Always wear your seat belt.

» TECHNICAL SUPPORT

www.zoneoffroad.com may have additional information about this product including the latest instructions, videos, photos, etc.

Send an e-mail to tech-zone@sporttruckusainc.com detailing your issue for a quick response.

888.998.ZONE Call to speak directly with Zone tech support.

» PRE-INSTALLATION NOTES

1. Special literature required: OE Service Manual for model/year of vehicle. Refer to manual for proper disassembly/reassembly procedures of OE and related components.
2. Adhere to recommendations when replacement fasteners, retainers and keepers are called out in the OE manual.
3. Larger rim and tire combinations may increase leverage on suspension, steering, and related components. When selecting combinations larger than OE, consider the additional stress you could be inducing on the OE and related components.
4. Post suspension system vehicles may experience drive line vibrations. Angles may require tuning, slider on shaft may require replacement, shafts may need to be lengthened or trued, and U-joints may need to be replaced.
5. Secure and properly block vehicle prior to installation of Zone Offroad Products. Always wear safety glasses when using power tools.
6. If installation is to be performed without a hoist, Zone Offroad Products recommends rear alterations first.
7. Due to payload options and initial ride height variances, the amount of lift is a base figure. Final ride height dimensions may vary in accordance to original vehicle attitude. Always measure the attitude prior to beginning installation.

Difficulty Level

easy 1 2 3 4 5 difficult

Estimated installation: 4-6 hours

Special Tools Required

30mm (1-3/16") Sockets

Heavy Duty Floor Jack and Stands

Tire/Wheel Fitment

Tire:

35 x 12.50

Wheel:

17x9, 4.5" backspacing

Kit Contents

Qty	Part		
2	Front Coil Spring	2	Bolt Pack - Sway Bar Drop
1	Front Track Bar	2	Front Bump Stop Extension
2	Front Track Bar Bushing	4	Zip Ties
1	Front Track Bar Sleeve	1	Bolt Pack - ABS Line
2	Radius Arm Drop Bracket	2	5" Rear Block
1	Bolt Pack - Radius Arm Brackets	2	Spring Plate
1	Sway Bar Drop (drv)	4	5/8" x 3-5/8" x 15" U-bolts/nuts/washers
1	Sway Bar Drop (pass)		

Important—measure before starting!

Measure from the center of the wheel up to the bottom edge of the wheel opening

LF _____ RF _____

LR _____ RR _____

Step 5 Note

If the taper does not release, try using a larger diameter pry bar. A loud pop will be heard when the taper releases. If available, a correct sized tie rod end tool can also be used to unseat the taper.

INSTALLATION INSTRUCTION

»» PRE-INSTALLATION NOTES

1. These vehicles, especially diesel models, are very heavy. Be sure that proper jacks/stands are used that are rated to handle the weight of the vehicle. Ensure that the vehicle is well supported before beginning the installation.
2. The factory front track bar bolt requires 405 ft-lbs of torque to be installed properly. Be sure you have the means of removing and installing this hardware properly. It is possible to install the hardware and torque to a more modest range (200 ft-lbs or so) and take the vehicle to a shop with the means to torque the hardware properly immediately after the installation is complete.
3. As a result of the location of the long radius arm suspension, support locations are limited. Use your best judgment while supporting the vehicle with sufficient strength stands at appropriate locations. The radius arms will need to move freely during this installation.

»» FRONT INSTALLATION

1. Park the vehicle on a clean, flat surface and block the rear wheels for safety.
2. Raise the front of the vehicle and proper support with jack stands under the frame rails - See Pre-Installation Note 3.
3. Remove the front wheels.
4. Support the front axle with a hydraulic jack.
5. Remove the track bar ball joint nut at the axle. **Figure 1** Thread the nut back on a couple of turns. Raise the axle a couple of inches with the jack. Place an appropriate sized pry bar between the axle mount and the track bar. **Figure 2** Lower the axle to pinch the pry bar between the track bar and axle mount. Take your hands off of the pry bar. Continue lowering the axle until the track bar unseats from the taper. Remove the nut and track bar from the ball joint. Save nut.



Figure 1



Figure 2

6. Disconnect the track bar from the driver's side frame mount. Remove the track bar from the vehicle. Save hardware.
7. Disconnect the front brake line brackets from the axle [Figure 3](#). Save hardware. Remove the front axle hub vacuum lines retaining clips from the axle/radius arm. [Figure 4A,B](#)

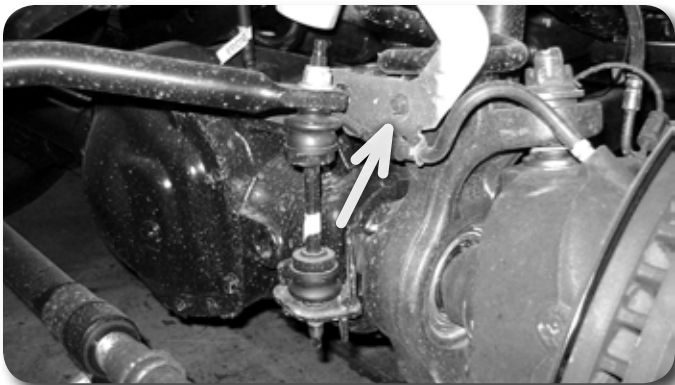

Figure 3



Figure 4A



Figure 4B

8. Remove the clips holding the front brake lines to the brackets on the frame. **Figure 5A** Using a proper line wrench, break loose the hard line at the junction block and rotate it 180 degrees. **Figure 5B** This will put the rubber line to the bottom. Tighten the hard line securely. Leave the brake line loose and save the retaining clip.



Figure 5A



Figure 5B

9. Disconnect the front sway bar from the frame. Swing the sway bar down and allow it to rest on the steering during the installation. Save frame mount hardware.
10. Remove the ABS brake lines from the retaining tabs on the radius arms. **Figure 6A** Carefully pull the plastic retaining clip free from the front of the radius arm. Remove the plastic tab from the rear portion of the arm. **Figure 6B** It will not be reused.



Figure 6A



Figure 6B

11. Disconnect the steering drag link from the pitman arm. Remove the cotter pin and castellated nut cap. Remove the nut and thread back on by hand a couple turns. Strike the end of the pitman arm near the drag link end to dislodge the taper from the pitman arm. **Figure 7** Remove the nut and the drag link from the pitman arm. Save all hardware.



Figure 7

12. With the axle still well supported with a jack, disconnect the front shocks from the axle mounts. Leave the shocks attached to the frame, they will be used for added axle support during the next portion of the installation. Save axle hardware.
13. Carefully lower the axle and remove the factory front springs. Take care not to over-extend any lines/hoses. Save the upper spring isolator to be reinstalled with the new springs.
14. Reconnect the shocks to the axle with the original hardware. The shocks will help support the axle during the radius arm bracket installation.
15. Remove the factory bump stops from the retainer cups on the frame. **Figure 8A** Remove the bolt holding the retainer cup to the frame and remove from vehicle. **Figure 8B**



Figure 8A



Figure 8B

16. Reinstall the retainer cups on the frame along with the provided 3" tall bump stop spacers. Fasten with a provided 8mm x 100mm bolt and washer. **Figure 9** Apply Loctite to the bolt and torque to 15 ft-lbs. Be sure the flat lip of the retainer cup is oriented out toward the coil spring. Reinstall the factory bump stop into the retainer cup.

Step 16 Note

The bump stop extension hardware is located in hardware pack #906.



Figure 9

17. Locate and loosen the four radius arm mounting bolts at the axle. **Figure 10** Once again make sure that the axle is well supported by a jack.



Figure 10

Step 17 Note

The driver's side upper nut is welded to the radius arm.

18. Starting with the passenger's side, remove the upper radius arm mounting bolt at the axle. It may be necessary to temporarily remove the shock from the axle mount to remove the bolt. Remove the radius arm bolt at the frame **Figure 11** and lower the radius arm from the frame bracket. Save hardware.



Figure 11

19. Install the new provided radius arm bracket into the factory frame bracket. Align the hole in the bracket with the factory mount holes and install 3/4" x 5" bolts, nuts and washers in the holes. **Figure 12** With both bolts installed, torque hardware to 250 ft-lbs.



Figure 12

20. Swing the passenger's side radius arm up into the new bracket and fasten with the factory hardware. Leave hardware loose.
21. Repeat the bracket installation on the driver's side.
22. With both brackets installed, reattach the upper radius arm mount to the axle with the factory hardware. Leave hardware loose. All radius arm hardware will be tightened with the weight of the vehicle on the suspension.
23. With the axle still well supported, disconnect the shocks from the axle and frame. Save the axle mount hardware.

Step 19 Note

Radius arm bracket hardware is located in hardware pack #430.

The new bolts will fit tight in the factory bracket. Installing them simultaneously will help to align the bracket holes. In some cases, because of varying tolerance the front factory bracket hole may need to be clearanced slightly.

24. Lower the axle just enough to install the new coil springs along with the factory upper rubber isolator. Once installed, rotate the coil so it seats properly in the axle mount. Raise the axle until the coil is seated in the upper mount.
25. Locate the new provided shocks, bushings and sleeves. Each shock is supplied with a short and a long bushing/sleeve set. Identify the bushings and sleeves. The longer bushing/sleeve installs in the BODY end of the shock. Lightly grease and install the bushings/sleeves in the correct locations.
26. Locate the new front shocks, bushings and sleeves. Install the bushings and sleeves into the shock eyes. Install the shocks using the factory lower hardware and provided stem hardware.
27. Torque shock hardware at axle to 100 ft-lbs. Tighten stem hardware until bushings deform.
28. Locate the new sway bar drop brackets. Install the brackets on the frame with the original sway bar mount hardware. When installed the brackets should offset toward the front of the vehicle and the open face point to the inside. **Figure 14** Leave hardware loose.

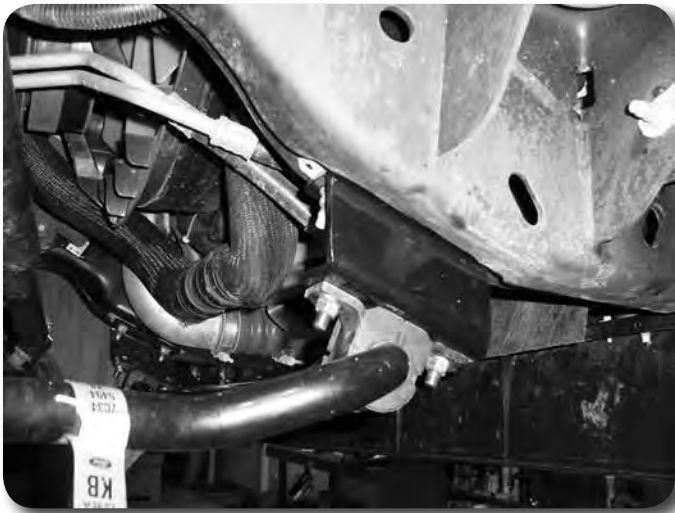

Figure 14

29. Attach the sway bar to the new drop brackets with the provided 3/8" hardware. Torque the factory hardware and new 3/8" hardware to 30 ft-lbs.
30. The ABS lines need to be rerouted along the frame. Make a mark on the frame approximately 1-1/2" behind the coil bucket and 1-1/2" from the bottom of the frame. Drill a 7/32" hole at the mark. Drill a second 7/32" hole in the inner fender liner, straight back from the first hole location. **Figure 15A**

Step 25 Note

The suspension will have to be compressed slightly to attach the shocks.

Step 28 Note

Sway bar drop hardware is located in hardware pack #422

Step 29,30 Note

All ABS line bracket hardware is located in hardware pack #656.



Figure 15A



Figure 15B

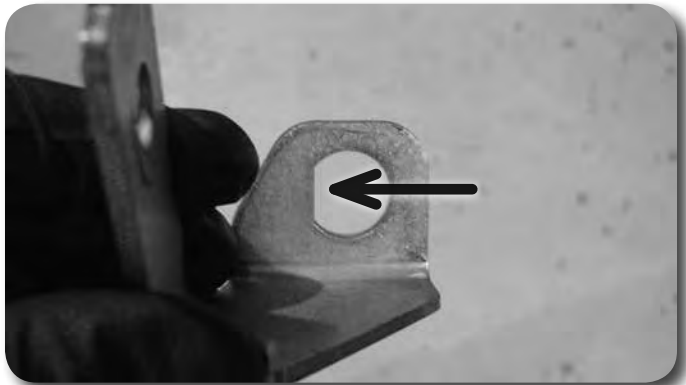

Figure 16A



Figure 16B



Figure 16C

31. Locate the provided wire clamps, 1/4" self tapping bolts and mountable zip ties (tree on the end). With the suspension at full extension (hanging from shocks) ensure that the ABS line still has some slack from the new mounting point on the frame to the axle. Fasten the line to the frame with the wire clamp and 1/4" self-tapping bolt. **Figure 15B** Attach the loose end inside the inner fender with the mountable zip tie. Note: The rubber collar on the ABS line can be slid on the line using a little silicone spray.
32. Reattach all vacuum lines. Use the provided zip ties where needed.
33. Remove the factory front brake line brackets from the frame. The brackets have a squared edge in the brake line mounting hole. **Figure 16A** Using a file or rotary grinder, remove the square edge to form a complete round hole. **Figure 16B** Reattach the brackets to the frame tighten securely with the factory hardware. Install the brake line junction in the bracket from the bottom and fasten with the factory retaining clip. **Figure 16C**
34. Properly bleed the brake system of air and top off the brake fluid reservoir with the proper type of fluid (see owners manual).
35. Reattach the steering drag link to the pitman arm. Torque nut to 148 ft-lbs. Install the original castellated nut cap and new 1/8" cotter pin.
36. Locate the provided new front track bar, track bar bushings and sleeve. Lightly grease and install the bushings and sleeve into the track bar.
37. Attach the new assembled front track bar to the original ball joint mount of the passenger's side of the axle. **Figure 17** Fasten with the factory nut and torque to 184 ft-lbs. The frame end will be attached with the vehicle's weight on the suspension.

Step 34 Note

New cotter pin is located in hardware pack #656.



Figure 17

38. Install the front wheels and lower the vehicle to the ground. Torque lug nuts to 165 ft-lbs.
39. Bounce the front of the vehicle to settle the suspension. Torque all factory radius arm hardware to 220 ft-lbs.
40. Install the new track bar into the factory frame bracket. **Figure 18** Lightly grease the faces of the bushings to ease installation. Fasten with the factory hardware and torque to 405 ft-lbs.

Step 39 Note

See pre-installation note #2.

The track bar end should fit tight into the bracket. If necessary, use a heavy rubber dead-blow rubber hammer to help align the end into the bracket.



Figure 18

41. Check all hardware for proper torque.

» REAR INSTALLATION

1. Block the front wheels for safety.
2. Raise the rear of the vehicle and support with jack stands under the frame rails just ahead of the spring hangers.
3. Remove the wheels.
4. Support the axle with a hydraulic jack.
5. Remove the factory shocks. Retain all mounting hardware.
6. Disconnect the passenger's side spring u-bolts. Using two C-Clamps, clamp the leaf spring on each side of the top u-bolt plate. **Figure 19** Remove the center pin

Step 5 Note

The factory rear block will vary depending on the vehicle model. F-250s will have a 1-7/8" block and F-350s will have a 3-3/4" block. In both cases, replacing the factory block with the new provided block will net the same level stance regardless of vehicle model.

nut and remove the u-bolt plate. Reinstall the center pin nut and torque to 40 ft-lbs. The u-bolts, top plate and bottom plate will not be reused.

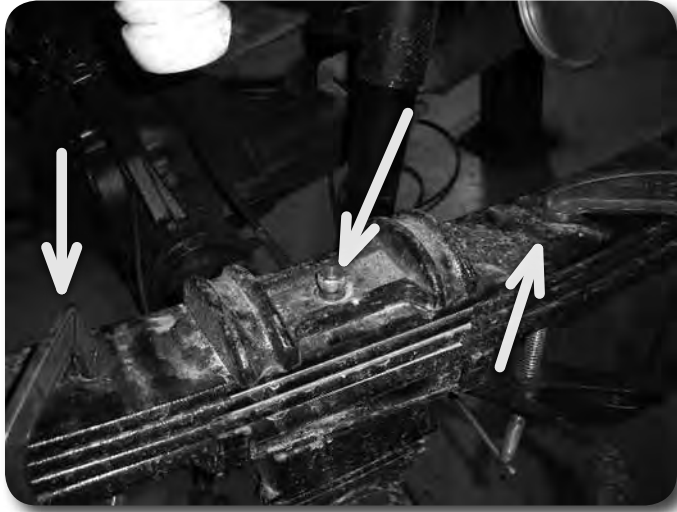

Figure 19

7. Remove the factory lift block. It will not be reused.
8. Models equipped with overload leaves will need the separation block modified. Trim the rotation tabs from the front side of block on both the inside and outside of the block. Use extreme care near the fuel tank, do not use any method that will create sparks if the block is not removed when modified. A sawzall is highly recommended. **Figure 20**

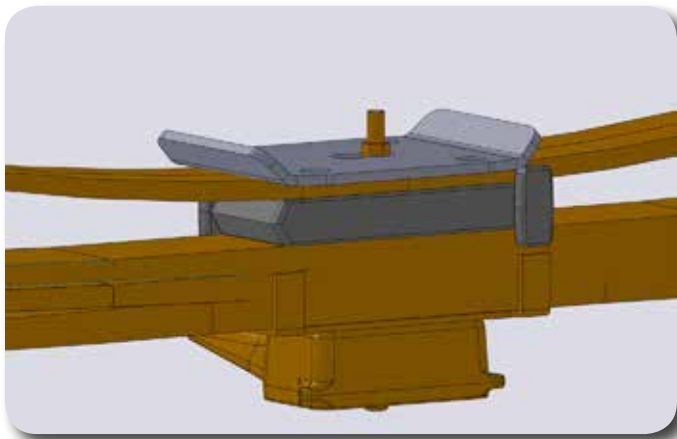

Figure 20

9. Lower the axle enough to place the provided 5" lift block between the axle and the leaf spring. Position the block so the bump stop wing faces inward. Make note that there are two center pin holes in the new blocks. The center pin will need to be aligned to the rear hole. This will ensure the axle moves slightly forward and the wheels are aligned properly in the wheel well.
10. Raise the axle to engage the block spring alignment pins. Be certain the leaf center pin aligns with the REAR hole in the new lift block. Position the new u-bolt plate on the top of the spring over the center pin nut. Position the plate so the bolt pattern is shifted forward on the spring. **Figure 21** Fasten the entire assembly with the provided u-bolts, high nuts and washers. Snug but do not torque the u-bolts at this time.

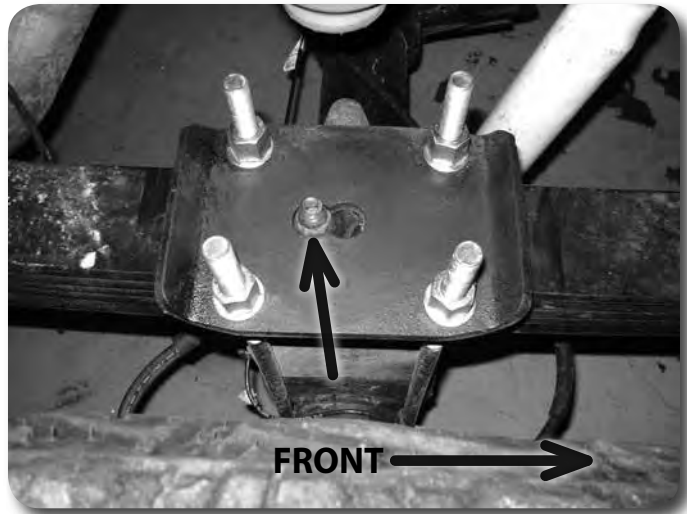

Figure 21

11. Repeat block installation of the driver's side. Take care not to over extend the brake lines. **Note:** The parking brake cable bracket will need to be removed from the spring center pin. Figure 22



Figure 22

12. If more parking brake cable slack is needed, remove the cable from the rear-most retaining bracket on the frame. Figure 23



Figure 23

13. The brakelines may require additional slack. Located the factory bracket on the axle. Using an adjustable wrench, carefully bend the bracket so the fittings are positioned vertical to allow more slack. Figure 24

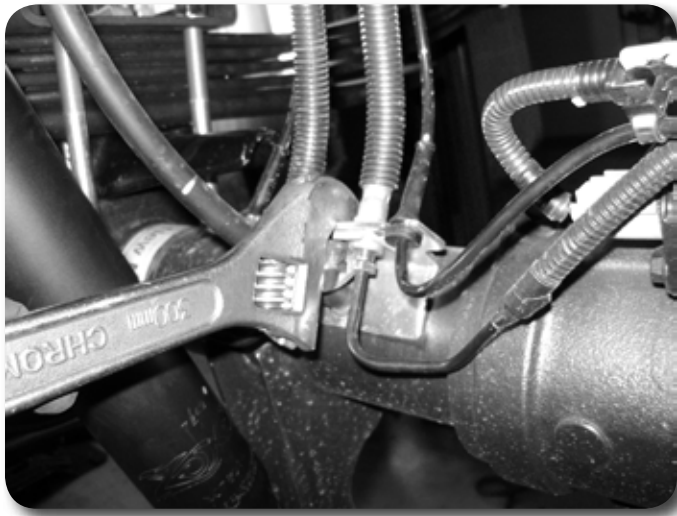

Figure 24

14. Install the new shocks with the original mounting hardware.
15. Install wheels and lower the vehicle to the ground.
16. With the weight of the vehicle on the axle, torque the u-bolts to 130-150 ft-lbs.

»» POST INSTALLATION

1. Check all hardware for proper torque. Check hardware after 500 miles.
2. Be sure the brake system has been properly bled and the brake fluid is topped off.
3. The steering wheel will need to be re-centered. This is done by adjusting the drag link collar near the passenger's side steering knuckle. Torque clamps to 41 ft-lbs. Thread the collar to lengthen the drag link.
4. Adjust headlights.

Post-Installation Warnings

1. Check all fasteners for proper torque. Check to ensure for adequate clearance between all rotating, mobile, fixed, and heated members. Verify clearance between exhaust and brake lines, fuel lines, fuel tank, floor boards and wiring harness. Check steering gear for clearance. Test and inspect brake system.
2. Perform steering sweep to ensure front brake hoses have adequate slack and do not contact any rotating, mobile or heated members. Inspect rear brake hoses at full extension for adequate slack. Failure to perform hose check/ replacement may result in component failure.
3. Perform head light check and adjustment.
4. Re-torque all fasteners after 500 miles. Always inspect fasteners and components during routine servicing.