



#C2552 2015 Chevy Colorado/GMC Canyon 5.5" Lift System

Read and understand all instructions and warnings prior to installation of product and operation of vehicle.

Zone Offroad Products recommends this system be installed by a professional technician. In addition to these instructions, professional knowledge of disassembly/ reassembly procedures and post installation checks must be known. Minimum tool requirements include the following: Assorted metric and standard wrenches, hammer, hydraulic floor jack and a set of jack stands. See the "Special Tools Required" section for additional tools needed to complete this installation properly and safely.

»» **PRODUCT SAFETY WARNING**

Certain Zone Suspension Products are intended to improve off-road performance. Modifying your vehicle for off-road use may result in the vehicle handling differently than a factory equipped vehicle. Extreme care must be used to prevent loss of control or vehicle rollover. Failure to drive your modified vehicle safely may result in serious injury or death. Zone Offroad Products does not recommend the combined use of suspension lifts, body lifts, or other lifting devices.

You should never operate your modified vehicle under the influence of alcohol or drugs. Always drive your modified vehicle at reduced speeds to ensure your ability to control your vehicle under all driving conditions. Always wear your seat belt.

»» **TECHNICAL SUPPORT**

www.zoneoffroad.com may have additional information about this product including the latest instructions, videos, photos, etc.

Send an e-mail to tech-zone@ridefox.com detailing your issue for a quick response.

888.998.ZONE Call to speak directly with Zone tech support.

»» **PRE-INSTALLATION NOTES**

1. Special literature required: OE Service Manual for model/year of vehicle. Refer to manual for proper disassembly/reassembly procedures of OE and related components.
2. Adhere to recommendations when replacement fasteners, retainers and keepers are called out in the OE manual.
3. Larger rim and tire combinations may increase leverage on suspension, steering, and related components. When selecting combinations larger than OE, consider the additional stress you could be inducing on the OE and related components.
4. Post suspension system vehicles may experience drive line vibrations. Angles may require tuning, slider on shaft may require replacement, shafts may need to be lengthened or trued, and U-joints may need to be replaced.
5. Secure and properly block vehicle prior to installation of Zone Offroad Products. Always wear safety glasses when using power tools.
6. If installation is to be performed without a hoist, Zone Offroad Products recommends rear alterations first.
7. Due to payload options and initial ride height variances, the amount of lift is a base figure. Final ride height dimensions may vary in accordance to original vehicle attitude. Always measure the attitude prior to beginning installation.

Difficulty Level

easy 1 2 3 **4** 5 difficult

Estimated installation: 6-8 hours

Special Tools Required

Cutoff Tools, Optional Welding, 36mm socket, T30 Torx bit, general hand tools

Tire/Wheel Fitment

305/55/20 w/ 5-1/4" Backspacing

295/70/17 or 18 w/ 4-1/2" Backspacing

Important Verify you have all of the kit components before beginning installation.

C2552 Kit Contents

ZONC2550

- 1 Steering Knuckle - DRV
- 1 Tie Rod End
- 1 9/16" SAE washer
- 1 Steering Stop

ZONC2551

- 1 Steering Knuckle - PASS
- 1 Tie Rod End
- 1 9/16" SAE washer
- 1 Steering Stop

ZONC2552

- 1 Front Crossmember
- 1 Rear Crossmember
- 1 DRV Diff Drop
- 1 Pass Diff Drop
- 1 Bolt Pack - Main Crossmember
- 1 Bolt Pack - Diff Drop Hardware

ZONC2553

- 1 Diff Skid Plate
- 1 Bolt Pack - Skid Plate / Bump Stop / Misc.
- 1 Bump Stop - DRV

- 1 Bump Stop - PASS
- 2 3/8" Serrated Edge Flanged Nut
- 2 Urethane Bump Stop
- 2 Sway Bar Link Stem
- 8 Sway Bar Link Bushing
- 1 Bolt Pack - Sway Bar Links
- 3 1/2" Rivet Nut
- 1 Bolt Pack - Rivet Nut Installation
- 1 Front Drive Shaft Spacer
- 1 Bolt Pack - Drive Shaft Spacer
- 3 9/16" USS Washer
- 4 Zip Tie
- 1 Loc-tite bottle

ZONC2554

- 2 5.5" Strut Spacer
- 1 Bolt Pack - Strut Spacers

ZONC2409

- 2 4" Rear Block
- 4 9/16" x 2-9/16" x 11-3/8" U-Bolt
- 8 9/16" SAE Washer
- 8 9/16" High Nut
- 5 Zip Ties

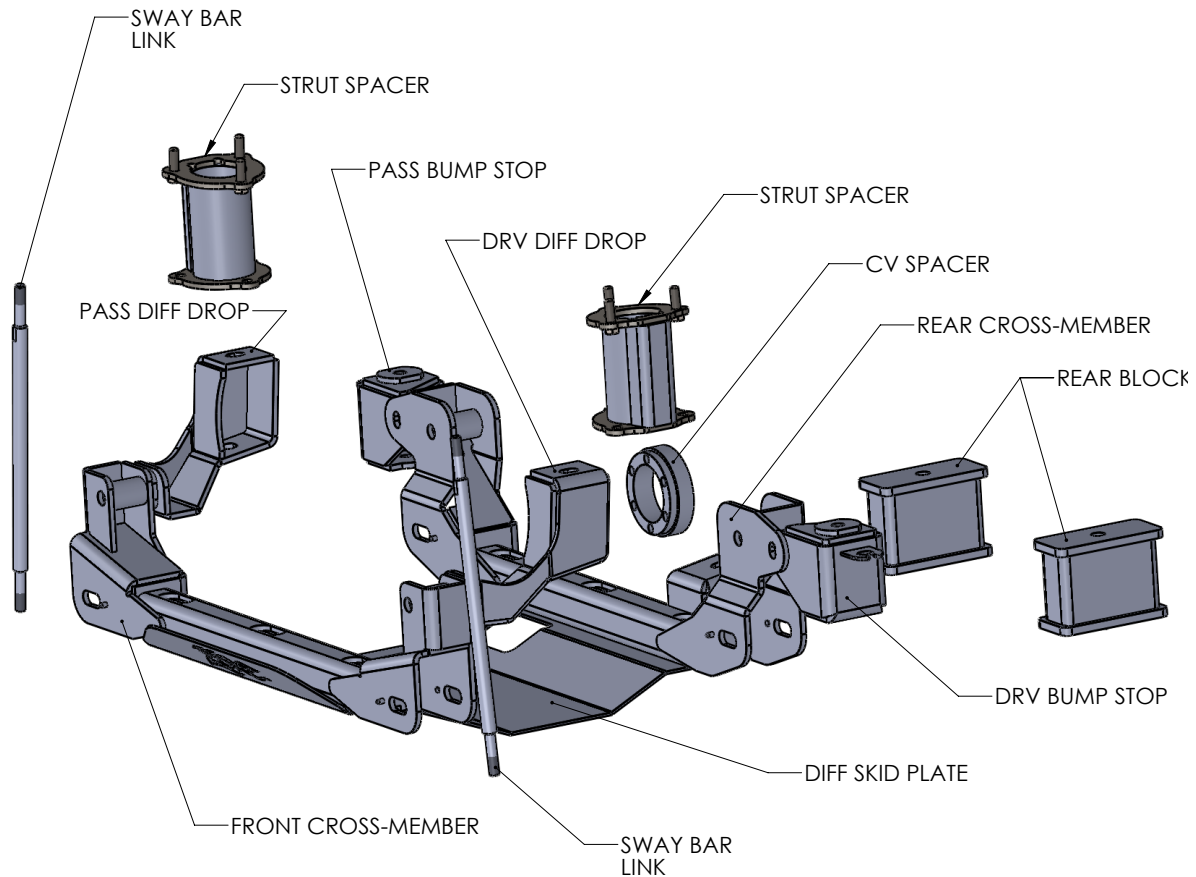

Installation Instructions

1. Park vehicle on clean, flat, and level surface. Block the rear wheels for safety.
2. Raise the front of the vehicle and support the frame rails with jackstands.
3. If a plasma cutter is to be used for frame bracket modification (later in installation), it is recommended to disconnect the battery at this time.

» DISASSEMBLY INSTRUCTIONS

4. Remove the front wheels
5. Remove the clip from the brake line to allow the brake line to detach from the bolt on brake line bracket.
6. Disconnect the ABS line from the bracket.
7. Remove the brake bracket from the side of the upper strut mount, Cut the Bracket to be able to slip the brake line out, Be careful not to cut the brake line itself, discard flanged bolt and bracket. (Fig 1).



Figure 1

8. Disconnect the brake caliper from the steering knuckle, retain mounting bolts. Hang the caliper out of the way; do NOT allow the caliper to hang from the brake line. (Fig 2)



Figure 2

Note:

These trucks are extremely sensitive to out of balance or tires with large lugs. A set of well balanced all terrain tires is recommended to keep the steering wheel from having a shimmy when driving.

Important—measure before starting!

Measure from the center of the wheel up to the bottom edge of the wheel opening

LF _____ RF _____

LR _____ RR _____

9. Remove the torx head bolt (T30) that attaches the rotor to the hub. Keep bolt for reinstallation. (Fig 3)



Figure 3

10. Disconnect the ABS wire from the backside of the steering knuckle, remove the clip and retain the bolt. (Fig 4)



Figure 4

11. Remove the ABS sensor from the side of the knuckle (T30), retain mounting bolt. (Fig 5)



Figure 5

12. Remove the CV nut, CV's have a tight fit to the hubs, it may be necessary to use an air hammer to separate them. Reinstall the nut a few turns to keep from damaging the CV shaft if this method is used. (Fig 6)



Figure 6

13. Remove the factory sway bar links, they will not be reused. (Fig 7)



Figure 7

14. Break the jam nuts loose on the tie rod ends at this time. The factory tie rod ends will be replaced later in the installation. (Fig 8)



Figure 8

15. Remove the ball joint nuts and tie rod end nuts. Use an appropriate tool to unseat the tapers from the factory knuckle. It is NOT recommended to use a hammer to separate the joints. (Fig 9)

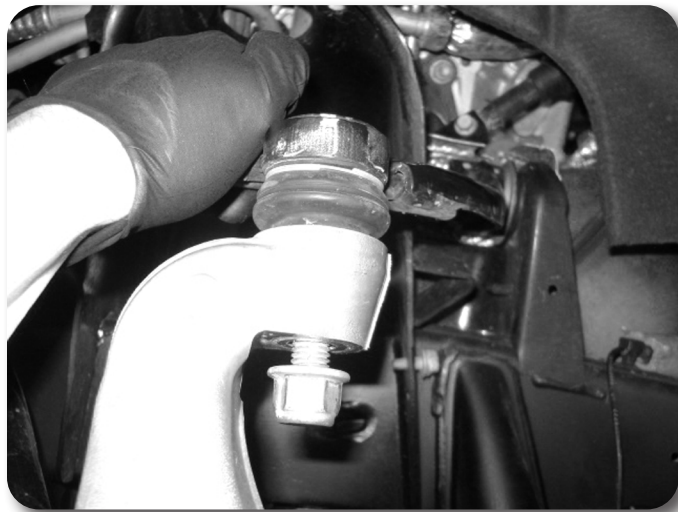

Figure 9

16. Remove the knuckle and hub assembly from the vehicle.
17. Remove the factory struts. Remove the lower bolt that attaches to the control arm and the 3 nuts that attach the strut to the upper strut mount. Do NOT remove the center nut that holds the strut assembly together. (Fig 11)

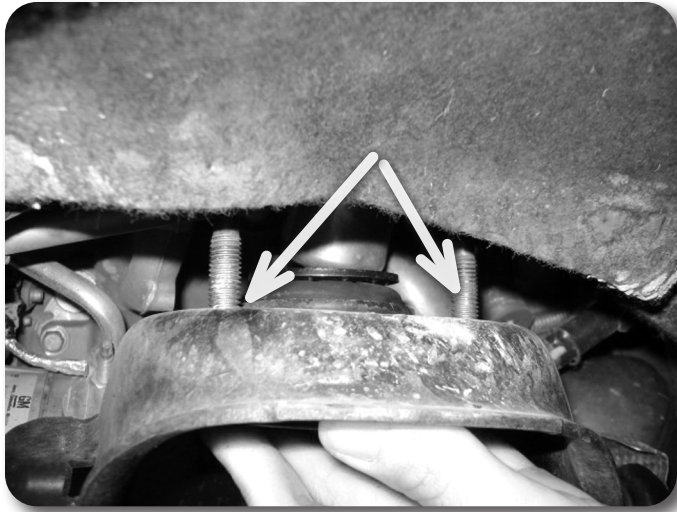

Figure 11

18. Remove the lower control arms. Retain the cam bolts / washers. (Fig 12, 13)



Figure 12



Figure 13

» DIFFERENTIAL REMOVAL

19. Disconnect the differential breather hose from the differential and the central axle disconnect wiring harness (Fig 14, 15)



Figure 14

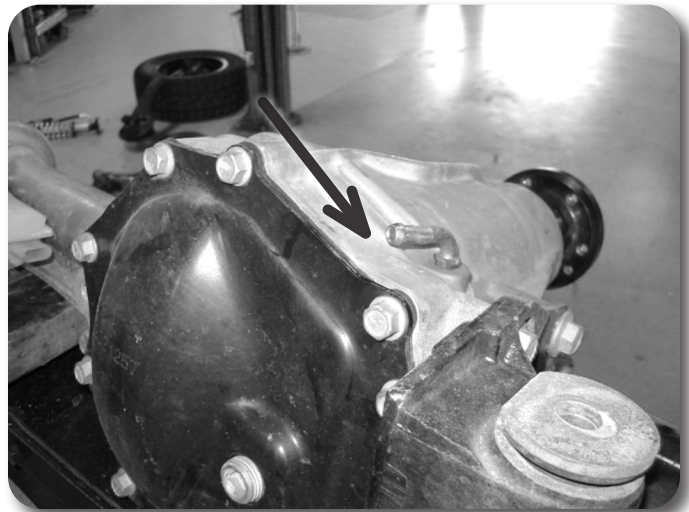

Figure 15

Figure 15 Note

The differential breather is difficult to access. It is easier to disconnect when the differential is lowered slightly..

20. Disconnect the front drive shaft from the differential. Discard front mounting hardware, it will not be reused) (Fig 16). Disconnect the front driveshaft from the transfer case, SAVE hardware, it will be reused. Remove the front driveshaft from the vehicle.



Figure 16

21. Remove both front splash guards (Fig 17 DSC03328., Discard splash guards they will not be reused.

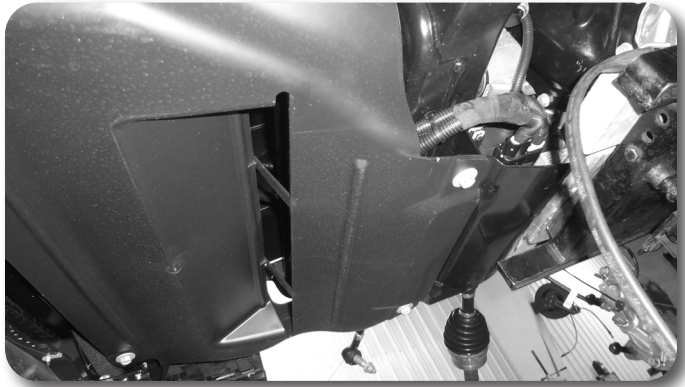

Figure 17

22. Remove the rear differential mounting bolt (Fig 18). Remove the rear factory cross member (Fig 19), Discard hardware, it will not be reused.



Figure 18

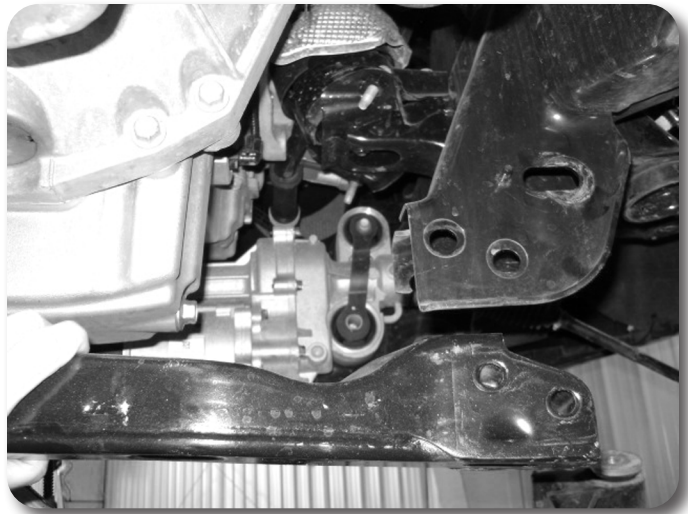

Figure 19

23. Support the differential with a hydraulic jack (transmission jack preferred). Remove the remaining two front mounting bolts and lower the differential from the vehicle. (Fig 20)

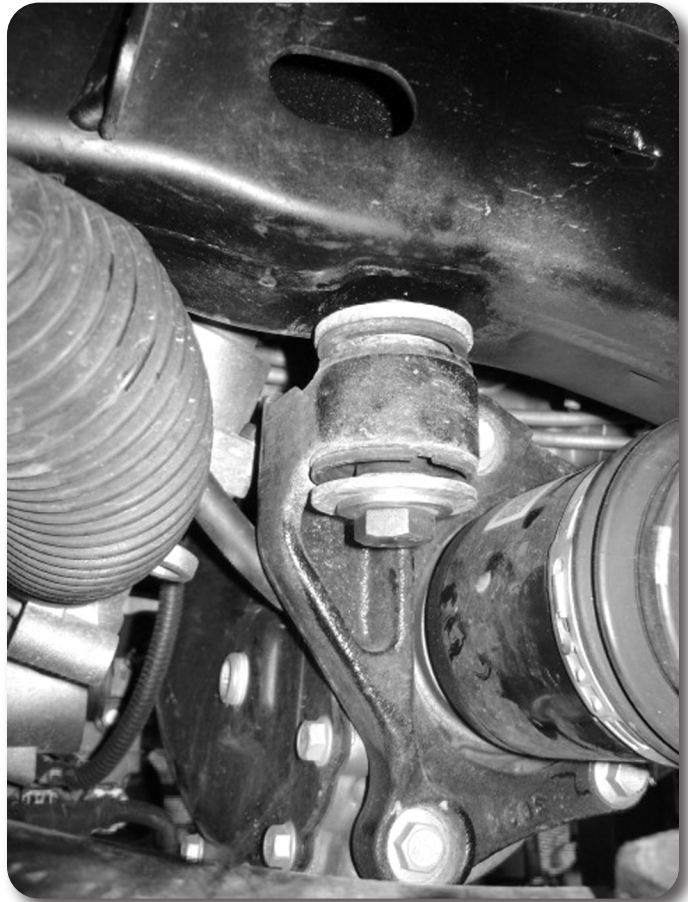

Figure 20

» FRAME MODIFICATION

24. The front factory lower control arm pocket will need to be modified to allow the new crossmember to be installed.

Front Pocket Modification

25. Measure down 1-1/8" from the BOTTOM of the factory slot on both the front and back sides and make a horizontal mark. Connect these two lines by measuring 'in' towards the center of the vehicle 1/8" and making a line that goes from front to back. Remove this section of material from the vehicle. Use a grinder to make the faces flush and remove any sharp edges so that the cross member can be installed easily. Coat with paint. (Fig 21a, 21b, 21c)

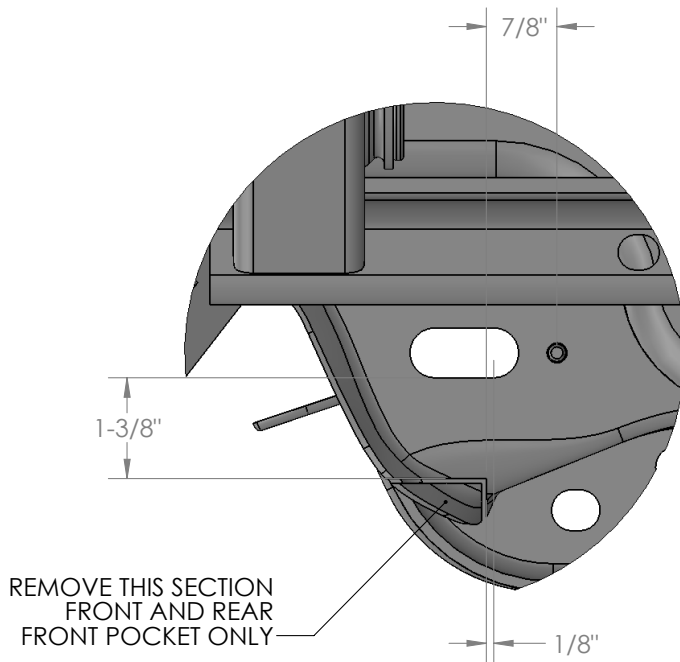

Figure 21a



Figure 21b



Figure 21c

Front Side of Passenger's Rear Pocket Modification

26. Draw a line that connects the top of the outside slot and bottom of the inside slot and remove the material from vehicle. Use a grinder to remove sharp edges, coat with paint when completed. (Fig 22a, 22b)

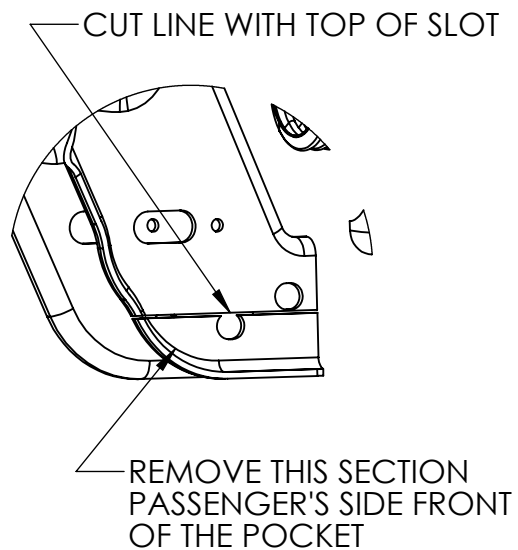

Figure 22a



Figure 22b

Driver's Rear Pocket Modification

27. Draw a horizontal line from the top of the outside slot.
28. Draw a vertical line from the center of the outside slot
29. Draw a line that would go through the center of the stock alignment pin that is perpendicular (about 45 degrees from horizontal) to the inside face.
30. Remove this section of material from the vehicle, remove any sharp edge with a grinder, and coat with paint. (Fig 23a, 23b)

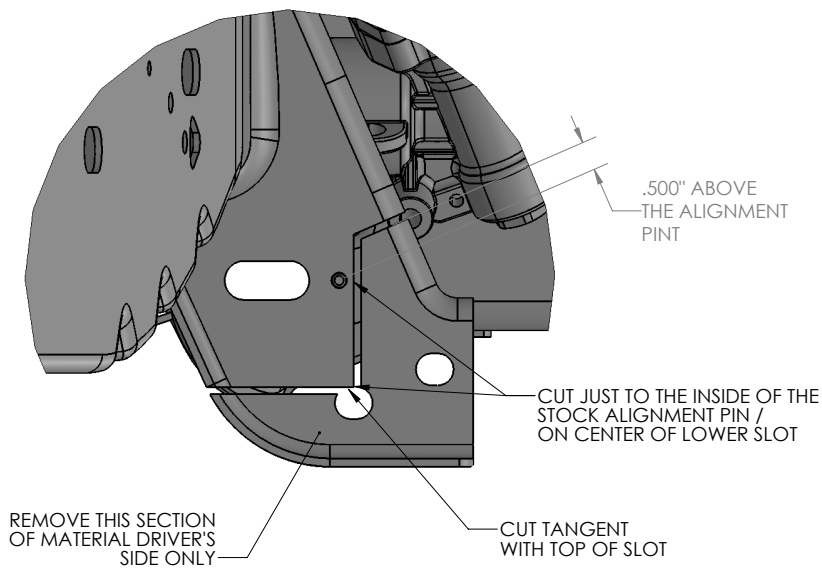

Figure 23a



Figure 23b

Step # 31 Note:

5/8" x 4-1/2" Crossmember Hardware is in Bolt Pack # 680

» CROSSMEMBER / DIFFERENTIAL INSTALLATION

31. Install the new front crossmember with new 5/8" hardware. Run the bolts from front to rear, Do NOT put the nuts on the bolts at this time. Crossmember are a tight fit if not enough material was removed during the frame pocket modification. (Fig 24)

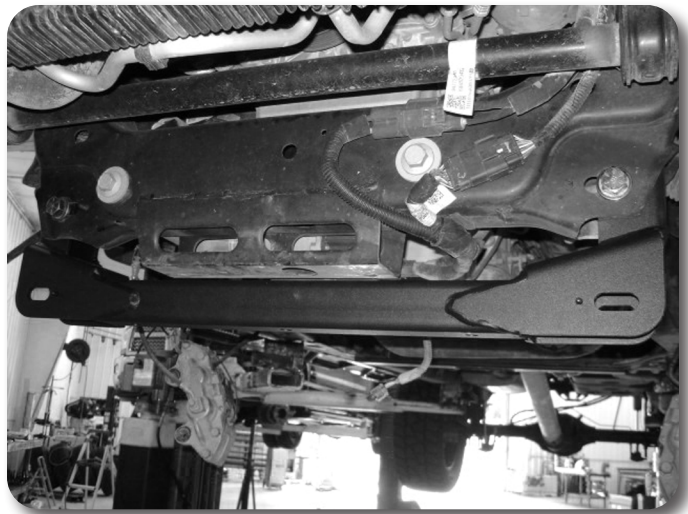

Figure 24

Step # 32 Note:

Differential hardware is in Bolt Pack # 681. Use 14mm x 30mm to attach the bracket to the frame.

32. Install the new differential drop brackets with new 14mm hardware to the frame. Brackets will attach to the front cross member hardware, attach with 5/8" nuts and washers. Leave all hardware loose. (Fig 25)



Figure 25

33. Install differential to the new drop brackets with 9/16" hardware. (Fig 26)

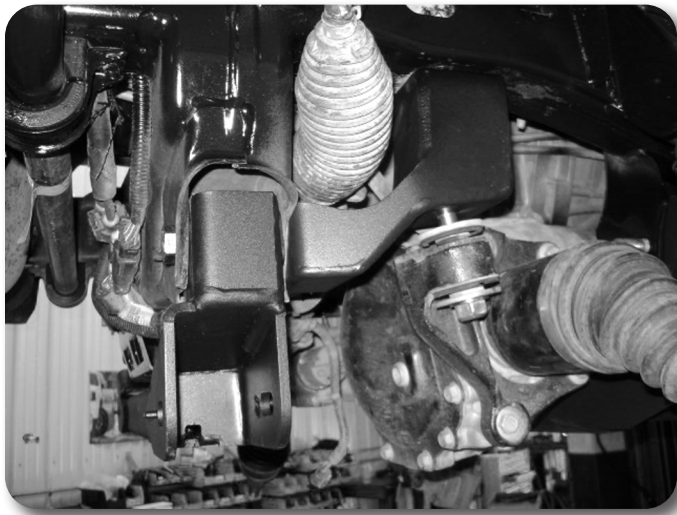

Figure 26

34. Raise the rear differential mount. Install rear cross member with new 5/8" hardware. Attach differential to rear crossmember with new 9/16" hardware. (Fig 27)



Figure 27

Step # 33 Note:

Differential hardware is in Bolt Pack # 681. Use 9/16" x 3-1/2" Hardware..

Step # 34 Note:

After test driving, if a vibration is present in the front driveshaft, use the provided 9/16" USS washers to space up the rear mount between the differential mount and the rear cross member. Gas model recommended to not use any spacer washers, Diesel model recommended to use two 9/16" spacer washers. Driving the vehicle and adding and removing spacer washers is the best way to reduce driveline vibrations.

35. Clearance the exhaust connection flange joint to create clearance for the front drive shaft. Grind the material away until the edge is flush with the edge of the flanged nut. (Fig 28)

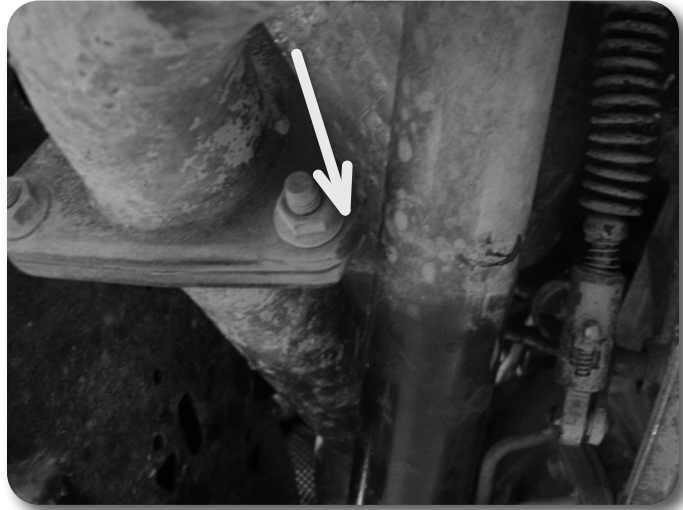

Figure 28

36. Attach the front driveshaft to the differential with the driveshaft spacer and new 10mm hardware with loc-tite. Tighten to 40 ft-lbs. (Fig 29)



Figure 29

37. Attach the front driveshaft to the Transfer Case with stock hardware with loc-tite. Tighten to 40 ft-lbs. Verify exhaust flange clears driveshaft.

Step # 36 Note:

Driveshaft hardware is in Bolt Pack # 828. Use 10mm x 75mm Hardware..Use loc-tite

» **BUMP STOP INSTALLATION**

38. Remove the factory bump stops (Fig 30)



Figure 30

39. Clearance the hole inside the bump stop cup to 11/16". Insert and seat 1/2" rivet nut. Follow rivet nut installation at the end of the instruction sheet. (Fig 31)

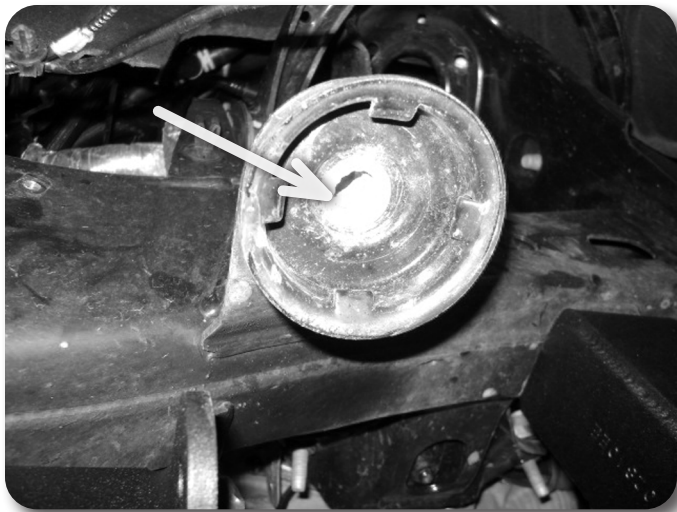

Figure 31

40. Attach the new bump stop extension to the rivet nut and rear crossmember with 1/2" hardware. Attach the bump stops to the bracket with 3/8" serrated edge flanged nut. (Fig 32a, 32b)

Step # 40 Note:

Bump Stop hardware is located in #684. Use 1/2" x 2" into the rivet nut, 1/2" x 1-1/4" to the rear crossmember, and 3/8" serrated edge flanged nut - included with the bump stop bag kit B1137 to secure the bumpstop to the bracket



Figure 32a

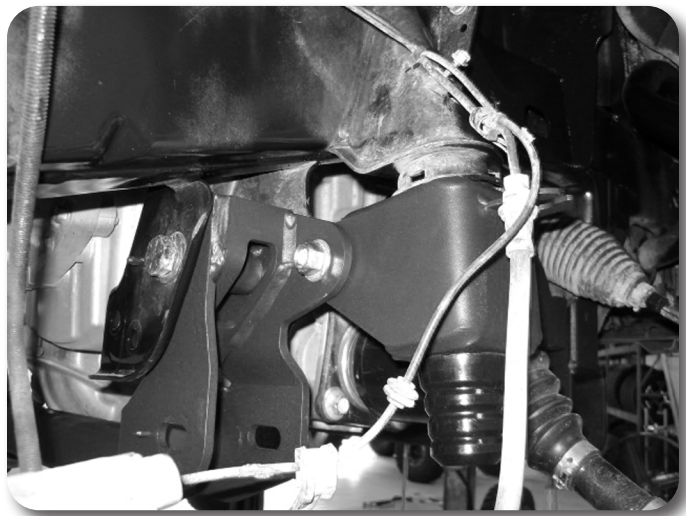

Figure 32b

41. Install lower control arms with factory cam bolts and nuts. Snug, but do not tighten at this time.
42. Go back and tighten 5/8" differential hardware to 120 ft-lbs., 9/16" and 14mm differential hardware to 90 ft-lbs. Tighten 1/2" bump stop hardware to 65 ft-lbs.

» STRUT MODIFICATION

43. Locate the upper strut spacers. Attach the strut spacers to the stock struts with factory hardware. Tighten to 40 ft-lbs. (Fig 33)



Figure 33

44. Install the strut and spacer into the vehicle. Attach the strut to the upper mount with new 3/8" nylock nuts and washers. Attach lower mount to the lower control arm with factory bolts. Tighten the 3/8" hardware to 35 ft-lbs; do NOT tighten the lower mount at this time. It will be done at the end of the installation with the vehicle weight on the ground. (Fig 34)



Figure 34

Step # 43 Note:

Use stock hardware. Tighten to 40 ft-lbs.

Step # 44 Note:

Strut Hardware is located in Bolt Pack #943. Use the 3/8" nuts with washers to attach the strut to the frame. Use the factory lower hardware at lower mount.

» **KNUCKLE ASSEMBLY**

45. Remove the factory hub and dust shield from the stock knuckles. Transfer them over to the new steering knuckle. Note: You MUST install the dust shield, failure to do so will cause ABS problems. (Fig 35)

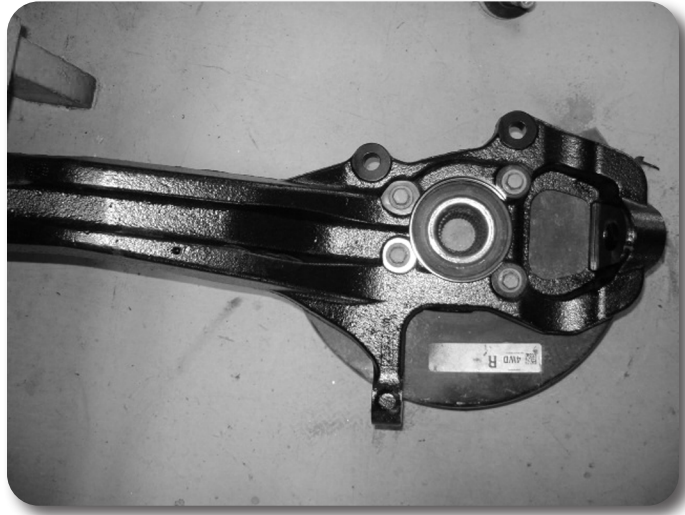

Figure 35

46. Apply loc-tite to the factory hub bolts, and tighten hub hardware to 95 ft-lbs.
47. Install grease zerk into new tie rod ends. Install the new tie rod ends onto the factory inner tie rods. Grease the tie rod ends before driving the vehicle. (Fig 36)



Figure 36

48. Install new steering knuckle assembly to the lower control arm and run the CV shaft through the hub. Attach upper ball joint and new tie rod end to knuckle assembly, use the included washer under the nut for the tie rod end. Use stock hardware tighten lower ball joint to 92 ft-lbs, upper ball joint to 70 ft-lbs, tie rod end to 44 ft-lbs, and CV nut to 177 ft-lbs. (Fig 37)

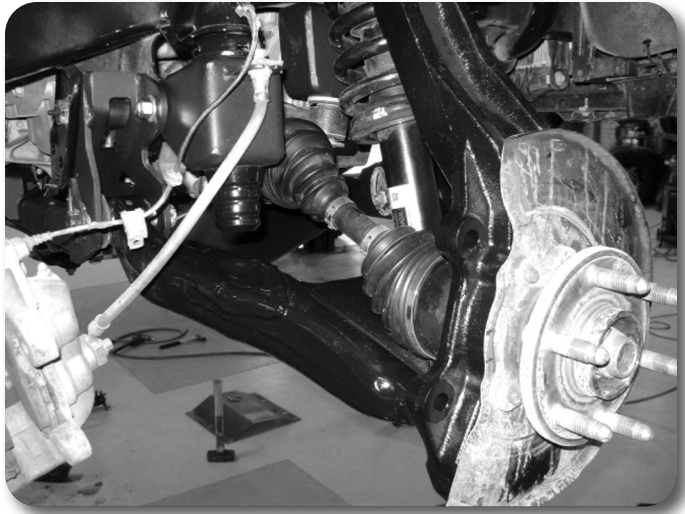

Figure 37

49. Reinstall the brake rotors with the torx bit holding the rotor to the hub assembly.
50. Reinstall the brake calipers with factory hardware. Tighten to 148 ft-lbs.
51. Clean any debris from the ABS sensors. Install the ABS sensors into the steering knuckle with factory hardware. Tighten to 11 ft-lbs. (Fig 38a)



Figure 38a

52. Attach the ABS sensor wire to the back of the steering knuckle with a new cable clamp and factory hardware. The grommet on the ABS wire can be slid by spraying it with silicone spray. Ensure there is adequate slack through wheel travel and full steering range of motion. (Fig 38b)

Step # 51 Note:

Any metallic debris on the ABS sensor can cause ABS errors, make sure the ABS sensor is clean before installing into the new steering knuckle.



Figure 38b

Step # 53 Note:

Sway bar hardware is in B1136 Bag Kit. Use the 7/16" nuts with washers located in Bolt Pack #682

53. Install new sway bar links with washers and bushings as shown. Attach with 7/16" nylock nuts.
54. Tighten new 7/16" nylock nuts to 12 ft-lbs. Do NOT over tighten the hardware.
Fig 39



Figure 39

» **BRAKE LINE MODIFICATION**

55. Carefully form the brake line to allow the mounting end to attach to the side of the bump stop cup. Reinstall the factory retaining clip to hold the brake line in place.
56. Reform the hard line slightly to create clearance from any sharp edges. Attach brake line to the side of the frame rail and the factory bump stop bracket by drilling $7/32$ " holes and using $3/16$ " cable clamps with $1/4$ " self threading bolts. Fig 40

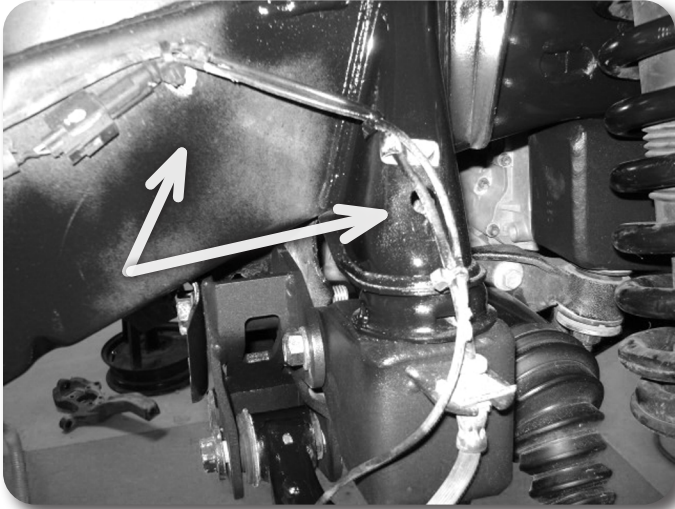

Figure 40

57. Recheck differential hardware for proper torque. Install skid plate with $3/8$ " hardware. Fig 41



Figure 41

Step # 55 Note:

Brakeline clips and hardware are in bolt pack # 684.

Step # 56 Note:

Differential skid plate hardware is in Bolt Pack # 684

» FINAL FRONT STEPS

58. Reinstall wheels. Tighten to factory specifications.
59. Lower vehicle to the ground. Adjust Cams as shown Fig 42a - front, Fig 42b - rear, Tighten Cam hardware to 170 ft-lbs. Tighten lower strut hardware to 95 ft-lbs.

CAM Placement

This is not the final alignment, but a good start for driving to an alignment shop. Adjust the toe-in to approximately 1/8" in, and straighten the steering wheel. Do NOT drive the vehicle with the steering wheel off-center.

42A - FRONT CROSSMEMBER SHOWN

42B - REAR CROSSMEMBER SHOWN

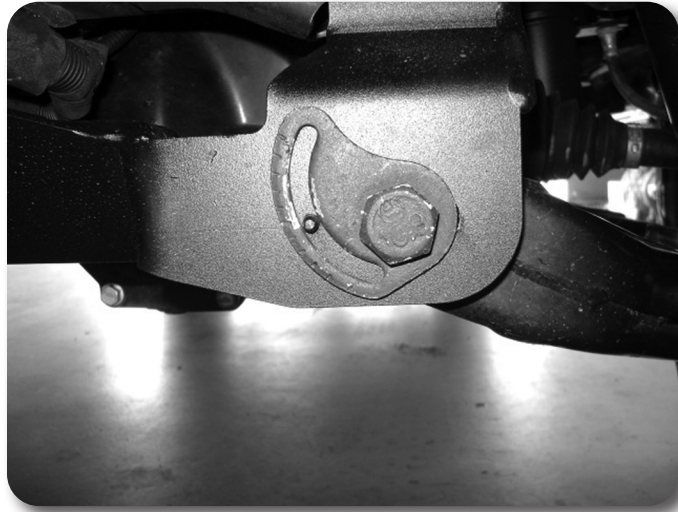

Figure 42a



Figure 42b

» REAR INSTALLATION

60. Block the front wheels for safety. Raise the rear of the vehicle and support frame rails with jackstands.
61. Remove the stock wheels and tires.
62. Disconnect the ABS wire from the clip on the side of the frame rail, this will allow extra slack in the ABS line. **Figure 43**



Figure 43

63. Remove the e-brake cable guide bracket from the side of the frame rail on the driver's side. It will not be reinstalled.
64. Form the stock brake line upper bracket 'down' to gain adequate slack. Use an adjustable wrench to form the stock brake line bracket down. **Figures 44a, 44b**



Figure 44a



Figure 44b

65. Working on one side of the vehicle at a time. Support the axle with a hydraulic jack, remove the factory u-bolts. Remove the stock shocks, retain hardware.
66. Diesel Models Only (Step #62-66): To remove the driver side upper shock bolt the DEF tank may be needed to be slid over to provide clearance. If the bolt cannot be removed, follow these instructions to provide clearance to the DEF tank.



Figure 45

67. Lower the spare tire and remove the spare tire from the vehicle. Follow the factory manual for removal of the spare tire. Remove the heat shield protecting the spare tire from the exhaust. There are 3 plastic push pins supporting the heat shield.

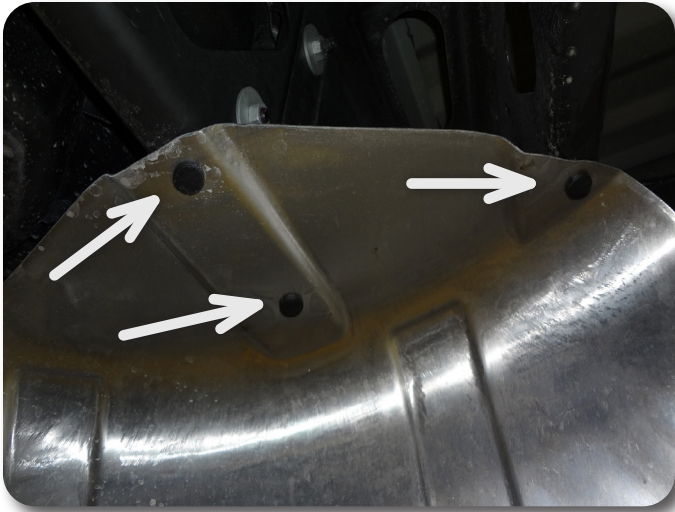

Figure 46

68. Support the DEF tank with a jack. Remove the two bolts supporting the front of the DEF tank. Remove the bolt on the passenger side of the DEF tank

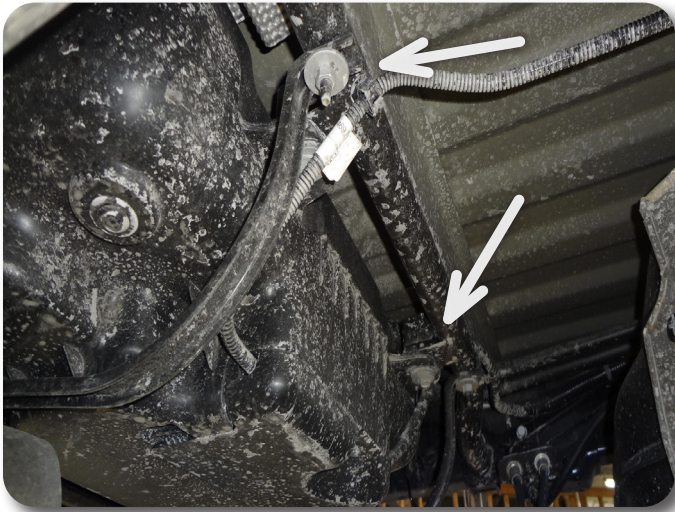

Figure 47



Figure 48

69. Remove the two nuts on the back side of the DEF tank. The support brackets on the back side of the DEF may also need to be loosened in order to slide the DEF tank over.



Figure 49



Figure 50

70. Slide the DEF tank towards the passenger side of the vehicle until there is enough clearance to remove the driver side upper shock bolt. Install the new shock with the OEM shock bolt. After the new shock is installed, reinstall the DEF tank, spare tire heat shield, and spare tire in the reverse sequence.
71. Lower the axle and install new lift block. Install new u-bolts with nuts and washers. Snug but do not tighten at this time. **Figures 51a, 51b**



Figure 51a

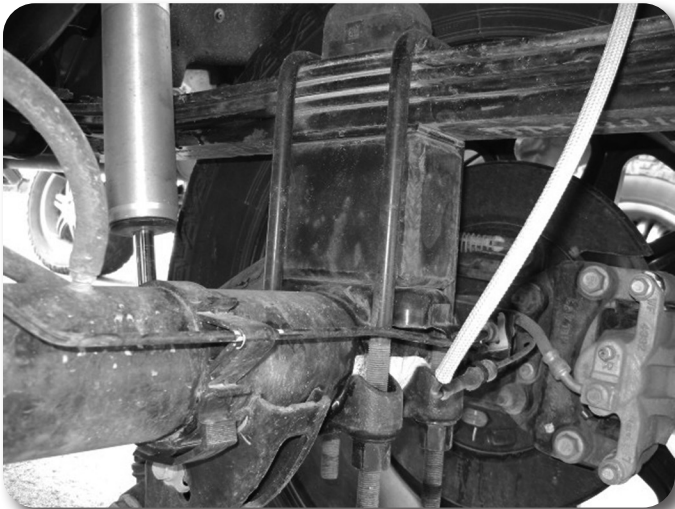

Figure 51b

72. Repeat block installation on opposite side of vehicle.
73. Grease and install new bushings and sleeves into shocks. Install the shocks with factory hardware. Install the shocks with the body down towards the axle. Tighten to 55 ft-lbs.
74. Lower the axle and check for adequate slack in the brake lines and abs wire, adjust as necessary.
75. Slide the grommet on the ABS wire on the passenger's side by the exhaust up (use silicone spray to allow the grommet to slide easily). Slide the ABS wire heat shield tubing up and secure with a zip tie. **Figure 52a**
76. Attach the ABS wire to the u-bolt with included zip tie **Figure 52b**, repeat on opposite side.

Step # 72 Note:

Install new shocks with the body down at the axle with factory hardware.



Figure 52a



Figure 52b

77. Use two zip ties, secure the e-brake cables together in front of where the old e-brake cable guide bracket contacted the cables. **Figure 53**



Figure 53

78. Install wheels, tighten lug nuts to factory specifications.
79. Lower the vehicle to the ground and torque u-bolts to 110 ft-lbs.
80. Reconnect the battery.
81. Recheck all hardware for proper torque. Check again after 500 miles.
82. A front end alignment is now required. Ensure the lower cam bolts are torqued to 170 ft-lbs after alignment.

» **OPTIONAL WELD ON STEERING STOPS:**

83. Included are optional weld on steering stops. These can be welded to the lower control arm to reduce rubbing or eliminate any interference issues that may be present at full steering lock. Disconnect the battery, prep lower control arm for welding, weld steering stop onto the lower control arm as shown. Coat with paint when completed. Figures 54a, 54b



Figure 54a



Figure 54b

» **OPTIONAL FRONT FENDERWELL MODIFICATION FOR TIRE CLEARANCE:**

84. Remove the 4 lower T-15 Torx head bolts that hold the fenderwell to the plastic support piece. Figures 55a, 55b



Figure 55a

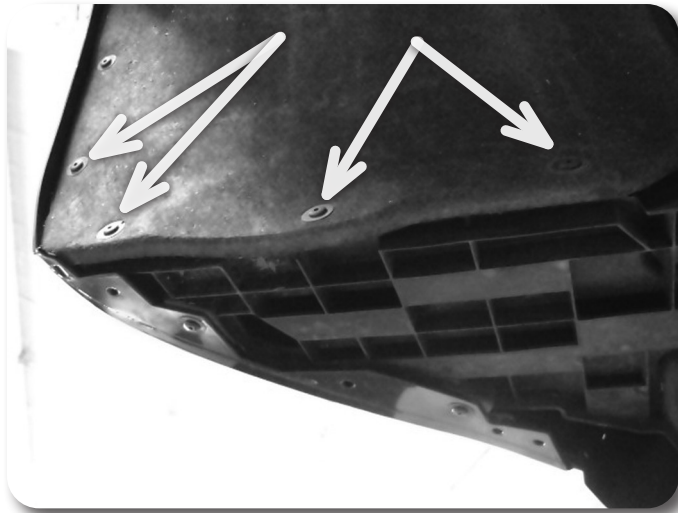

Figure 55b

Step # 84 Note:

A sawzall works well for trimming the factory plastic. A box cutter style knife with the blade heated by a MAP gas / propane torch cuts the factory plastic bumper cover nicely and leaves a good smooth finish.

85. Trim back to the first full support rib. Remove this section from the support piece. Figures 56a, 56b



Figure 56a



Figure 56b

86. Remove the nut clips from the trimmed piece. Hold the inner fenderwell up to the front support piece and drill new holes for the mounting hardware at a convenient location. Attach the inner fender to the plastic support piece with factory torx bit hardware. Trim a slight amount on the plastic bumper cover for additional clearance if required. **Figures 57a, 57b**



Figure 57a



Figure 57b

Rivet Nut Installation Instructions

» HOLE PREPARATION

87. Drill hole to appropriate size for rivet nut installation. 1/2" Rivnuts require an 11/16" hole and 3/8" Rivnuts require a 17/32" drill. It is critical that this hole is drilled to the correct size. Remove any burrs that could keep the rivet nut from seating flat against either side of the hole surface. **Figure 1A/B.**

Step 86 Note

If the correct drill size is not available, it is possible to drill the hole to an available smaller size and slowly grind it out to until the rivet-nut fits tight.

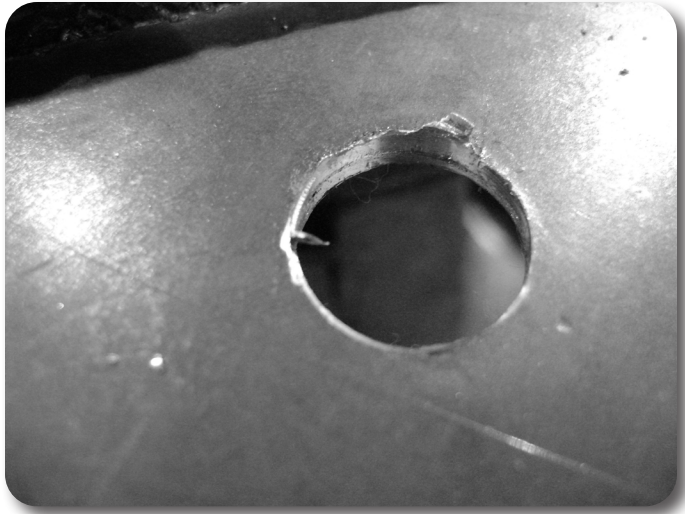

Figure 1A

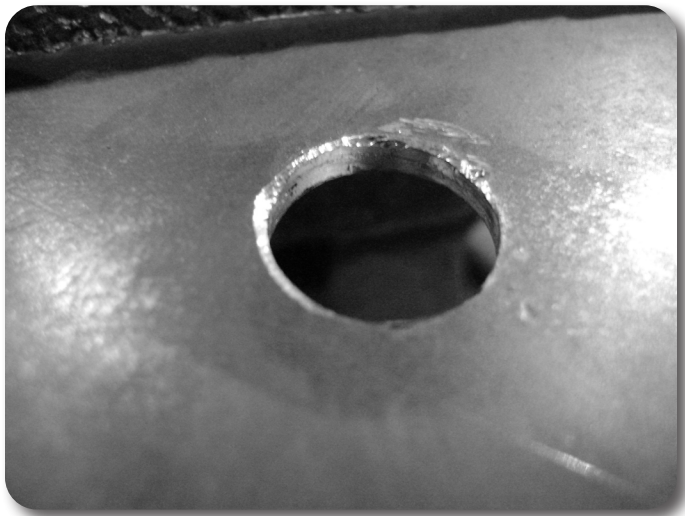

Figure 1B

» RIVET NUT INSTALLATION TOOL ASSEMBLY

88. For a 3/8" rivet nut, place the provided 3/8" SAE flat washer on the 3/8" x 1-1/2" bolt, followed by 7/16" hex nut and then a 3/8" serrated washer. **Figure 2** Thread this tool assembly into the rivet nut.

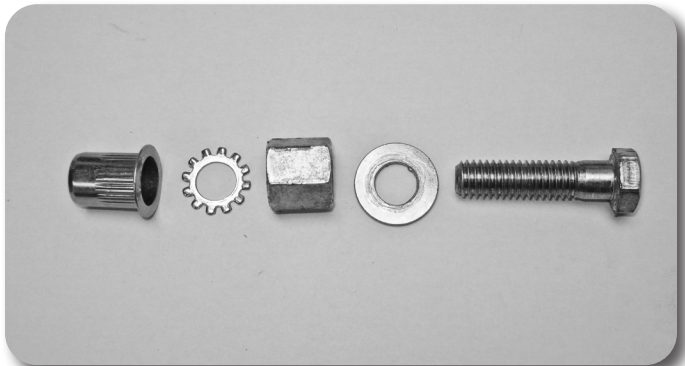

Figure 2

89. For a 1/2" rivet nut, place the provided 1/2" SAE washer on a 1/2" x 2" bolt followed by a 9/16" high nut and 1/2" serrated edge lock washer. Thread this tool assembly into the rivet nut as shown. **Figure 3.**

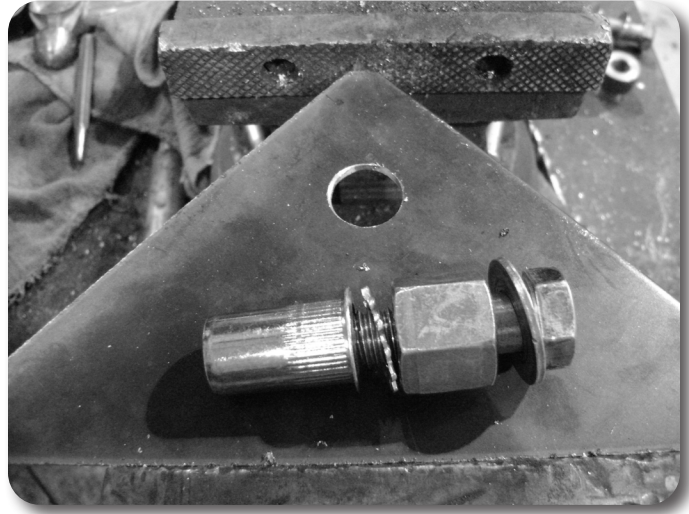

Figure 3 - 1/2" Rivet Nut Shown

» RIVET NUT INSTALLATION

90. Verify the correct size rivet nut for the application based on the thickness of material where the rivet nut is to be installed using the following chart.

Part Number	Thread Size	Body Length (in)	Material Thickness (in)		Drill Size (in)
			Min.	Max.	
95105A159	3/8-16	.690	.027	.150	17/32
95105A168	3/8-16	.805	.150	.312	17/32
95105A169	1/2-13	1.150	.063	.200	11/16
95105A170	1/2-13	1.300	.200	.350	11/16

91. Place the installation tool with the rivet nut threaded on the end into the appropriately sized hole.
92. For a 3/8" rivet nut, hold the nut closest to the rivet nut still with an 5/8" wrench and tighten the 3/8" bolt with a 9/16" wrench to set the rivet nut. Be sure to hold the rivet nut flush to the surface and square to the hole as it is tightened. **Figure 4**
93. For a 1/2" rivet nut, hold the nut closest to the rivet nut still with an 7/8" wrench and tighten the 1/2" bolt with a 3/4" wrench to set the rivet nut. Be sure to hold the rivet nut flush to the surface and square to the hole as it is tightened. **Figure 4**

Step 91 & 92 Note

If available, an impact gun is recommended for tightening the bolt to ensure the rivet nut remains square to the hole and to ease holding the nut from spinning.



Figure 4 - 1/2" Rivet Nut shown

» TORQUE SPECIFICATIONS

94. 3/8" rivet nuts will approach 40 ft. lbs for maximum grip strength. Do not exceed 45 ft-lbs when setting the rivet nut.
95. 1/2" rivet nuts will approach 90 ft lbs for maximum grip strength. Do not exceed 100 ft-lbs when setting the rivet nut.

» RIVET NUT TOOL REMOVAL

96. Once the center bolt is tightened, remain holding the nut from spinning with the wrench and loosen the center bolt to remove the installation tool.
97. Verify proper installation by checking for consistent rivet nut deformation to see the threads are square and centered to the rivet nut. Figure 5.



Figure 5

Step 93 & 94 Note

If using the recommended impact gun, use caution to not exceed the recommended torque specifications.

Step 95 *IMPORTANT*

It is very important to hold the nut as the bolt is loosened because the grip of the star washer will try to spin the rivet nut and ruin the installation.