



#C1400 Installation Instructions 2007 Chevy Tahoe/GMC Yukon 4" Combo Kit

Read and understand all instructions and warnings prior to installation of product and operation of vehicle.

Zone Offroad Products recommends this system be installed by a professional technician. In addition to these instructions, professional knowledge of disassembly/ reassembly procedures and post installation checks must be known. Minimum tool requirements include the following: Assorted metric and standard wrenches, hammer, hydraulic floor jack and a set of jack stands. See the "Special Tools Required" section for additional tools needed to complete this installation properly and safely.

» PRODUCT SAFETY WARNING

Certain Zone Suspension Products are intended to improve off-road performance. Modifying your vehicle for off-road use may result in the vehicle handling differently than a factory equipped vehicle. Extreme care must be used to prevent loss of control or vehicle rollover. Failure to drive your modified vehicle safely may result in serious injury or death. Zone Offroad Products does not recommend the combined use of suspension lifts, body lifts, or other lifting devices.

You should never operate your modified vehicle under the influence of alcohol or drugs. Always drive your modified vehicle at reduced speeds to ensure your ability to control your vehicle under all driving conditions. Always wear your seat belt.

» TECHNICAL SUPPORT

Live Chat provides instant communication with Zone tech support. Anyone can access live chat through a link on www.zoneoffroad.com.

www.zoneoffroad.com may have additional information about this product including the latest instructions, videos, photos, etc.

Send an e-mail to tech@zoneoffroad.com detailing your issue for a quick response.

888.998.ZONE Call to speak directly with Zone tech support.

Difficulty Level

easy 1 2 **3** 4 5 difficult

Estimated installation: 5-6 hours

Special Tools Required

Grinder/Cutoff Wheel

Tire/Wheel Fitment

33x11.50 w/stock wheel BS

» PRE-INSTALLATION NOTES

1. Special literature required: OE Service Manual for model/year of vehicle. Refer to manual for proper disassembly/reassembly procedures of OE and related components.
2. Adhere to recommendations when replacement fasteners, retainers and keepers are called out in the OE manual.
3. Larger rim and tire combinations may increase leverage on suspension, steering, and related components. When selecting combinations larger than OE, consider the additional stress you could be inducing on the OE and related components.
4. Post suspension system vehicles may experience drive line vibrations. Angles may require tuning, slider on shaft may require replacement, shafts may need to be lengthened or trued, and U-joints may need to be replaced.
5. Secure and properly block vehicle prior to installation of Zone Offroad Products. Always wear safety glasses when using power tools.
6. If installation is to be performed without a hoist, Zone Offroad Products recommends rear alterations first.
7. Due to payload options and initial ride height variances, the amount of lift is a base figure. Final ride height dimensions may vary in accordance to original vehicle attitude. Always measure the attitude prior to beginning installation.

Kit Contents

Qty	Part
2	Front Bumper Bracket
2	2" Spacer Sleeve - Front Bumper
12	2" Body Lift Block
1	Bolt Pack - Front Bumper
1	Bolt Pack - Rear Bumper
1	Bolt Pack - Body Lift
1	Rear Bumper Bracket (pass)
1	Rear Bumper Bracket (drv)
1	Parking Brake Cable Relocation Bracket
2	Strut Mount Spacer
1	Bolt Pack - Strut Spacer

Bolt Pack 256 – Front Bumper Hardware

Qty	Description
2	9/16"-12 x 7-1/2" bolt
4	9/16" SAE washer
2	9/16"-12 lock nut
4	3/8"-16 x 1" self tapping bolt
2	3/8"-16 x 1-1/4" bolt
4	3/8" SAE washer
2	3/8"-16 lock nut

Bolt Pack 257 – Rear Bumper Hardware

Qty	Description
6	9/16"-12 x 1-1/4" bolt
6	9/16" SAE washer
14	1/2"-13 x 1-1/4" bolt
28	1/2" SAE washer
14	1/2"-13 lock nut
4	3/8"-16 x 1" self tapping bolt

Bolt Pack 258 – Body Lift Hardware

Qty	Description
2	1/2"-13 x 6-1/2" bolt
4	1/2" SAE washer
2	1/2"-13 lock nut
10	14mm-2.00 x 160mm bolt
10	14mm washer

Bolt Pack 646– Strut Spacer

Qty	Description
4	7/16-14 x 3-1/2" Bolt
4	7/16-14 lock nut
8	3/8" USS washer

Important—measure before starting!

Measure from the center of the wheel up to the bottom edge of the wheel opening

LF _____ RF _____

LR _____ RR _____



Pre-Installation Notes

1. The rear bumper that holds the towing receiver will be modified. It is recommended that the rear bumper no longer be used for towing.
2. Save all hardware and plastic clips for reassembly.

Body Lift Installation Instructions

3. Block wheels for safety
4. Open the rear hatch.
5. Disconnect battery, remove negative first, then positive.
6. Remove the front splash guard. Save hardware.
7. Disconnect fog lights (if equipped), remove clip from light assembly **Figure 1**.

Step 4 Note

The rear hatch needs to be opened before the battery is disconnected

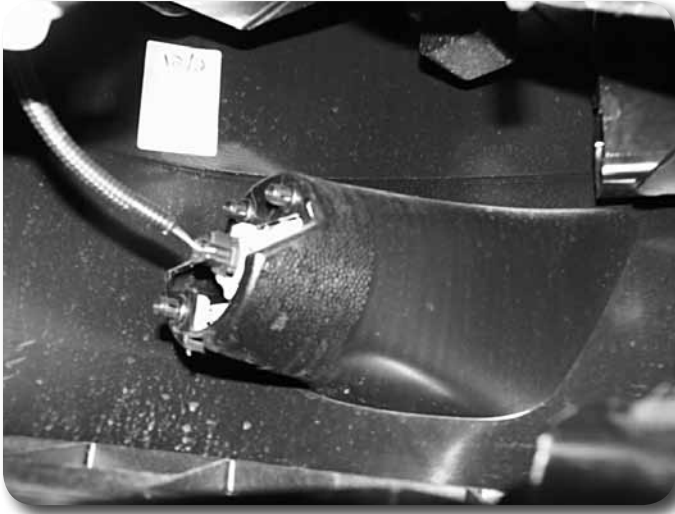

Figure 1

8. Remove 6 bolts at the top of the grill indicated in **Figure 2**.

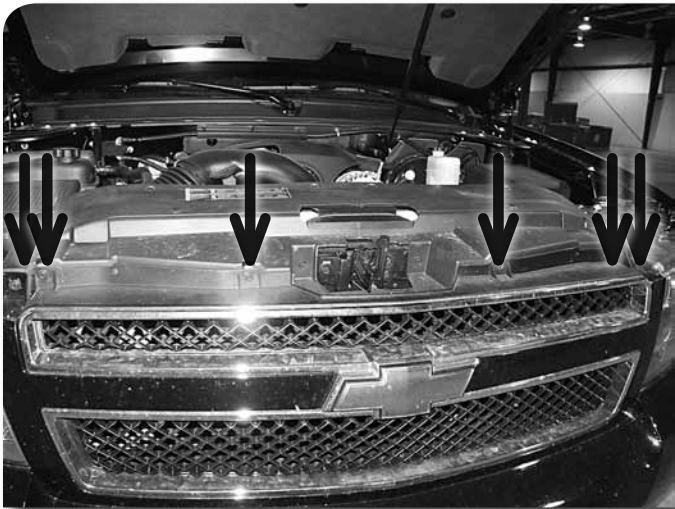

Figure 2

9. Remove 3 push plugs and 2 bolts indicated per wheel-well **Figure 3**.

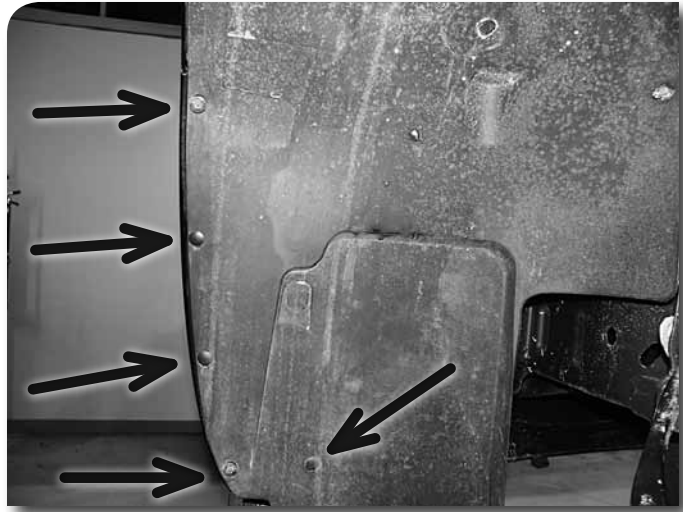

Figure 3

10. Note where the plastic bumper piece is located below frame alignment hooks. Measure down 2" and mark bumper for clearance. Figure 4. This will be trimmed once the bumper cover is removed.

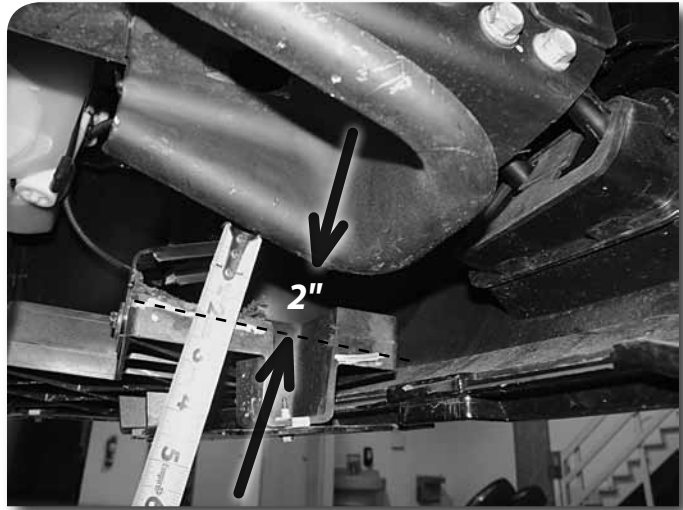

Figure 4

11. Flex the inner fender well out of the way and remove bolt as shown Figure 5. Repeat for opposite side.



Figure 5

12. Pull sides of bumper out Figure 6.



Figure 6

Step 12 Note:
The sides have clips that mount the bumper at the seam.

13. Pull bumper cover directly forward and remove from vehicle.
14. Remove tow hooks and save hardware.
15. Remove 2 bolts indicated that hold the steel bumper to frame rails Figure 7 and remove steel bumper from vehicle.

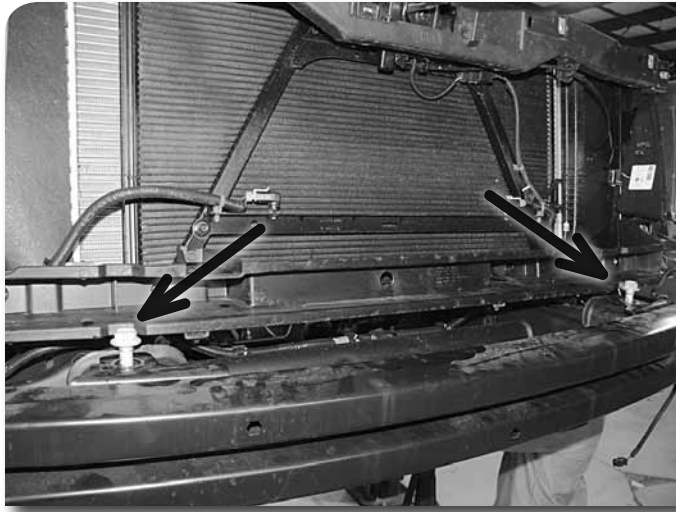

Figure 7

16. On the driver's side frame rail just below the driver's side door locate the parking brake cable. Disconnect the front half of the cable from the rear half. Compress the retaining clip and remove the front half of the cable from the body mount. Reroute the cable above the body mount near the top of the frame.
17. Remove 3 bolts in each wheel-well at rear of vehicle **Figure 8**.

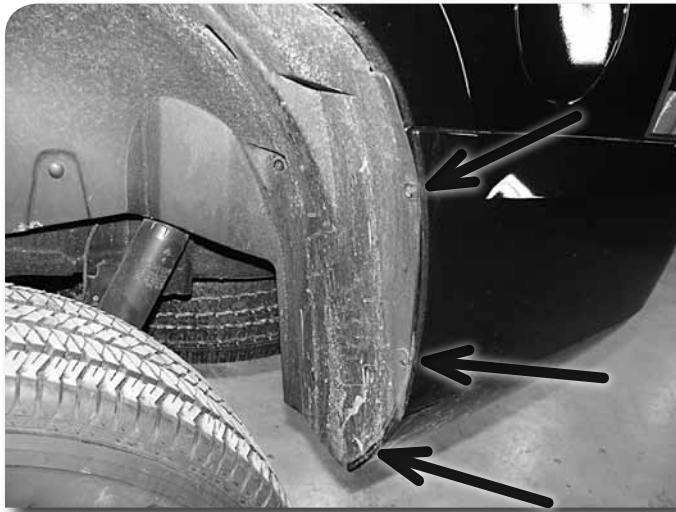

Figure 8

18. Disconnect wire harness that plugs into bumper cover on the passenger's side **Figure 9**.

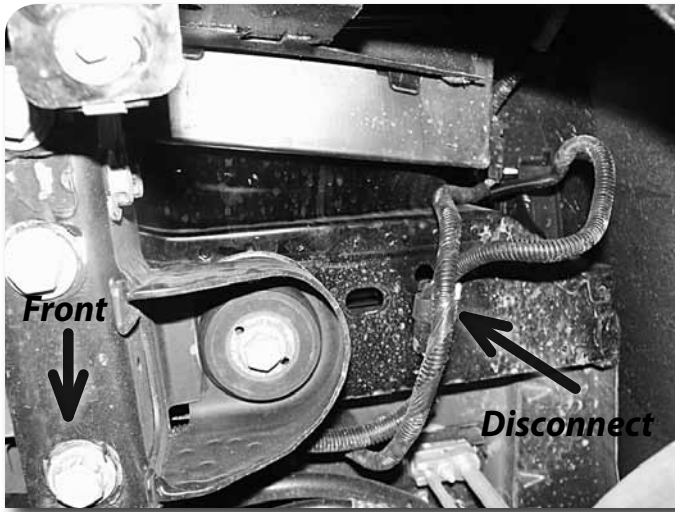

Figure 9

19. Remove 4 bolts and 2 plugs located in rear hatch area Figure 10.



Figure 10

20. Remove 2 lower bolts on the bottom side of the rear bumper cover Figure 11.



Figure 11

21. Pull sides of bumpers out (Same as front). The side clips are located where the bumper seam meets the body edge **Figure 12**.

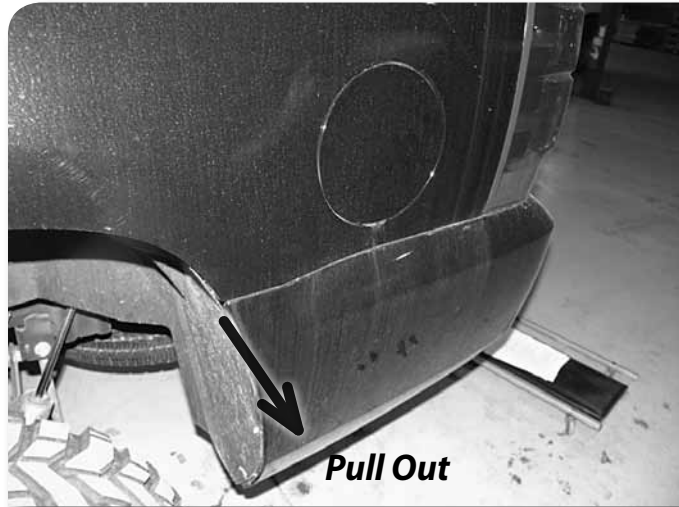

Figure 12

22. Pull bumper cover straight back and set aside.
23. Remove trailer hitch wire from retaining clips and disconnect plug from metal bumper. **Figures 13 & 14**.



Figure 13



Figure 14

24. Remove 5 bolts per side that attach the metal bumper to frame rails. Figure 11.
25. Remove metal bumper
26. Disconnect the emergency brake cable located below the driver's seat Figure 15.

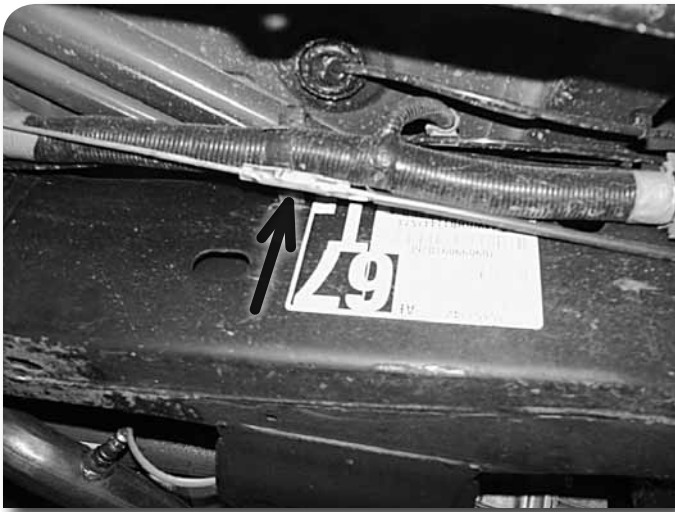

Figure 15

27. Mark orientation of steering shaft. Remove bolt that connects the steering shaft above steering rack and pinion. Do not disconnect shaft. Figure 16

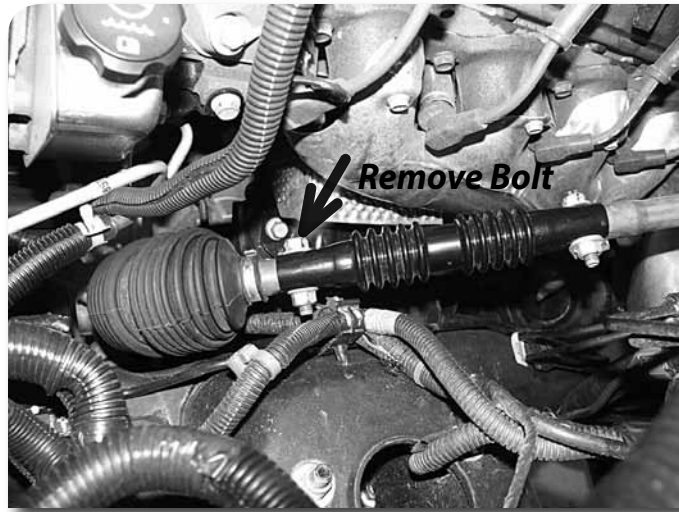

Figure 16

28. Remove front 2 body mounting bolts (Driver's and Passenger's side)
29. Remove 5 bolts from passenger's side of vehicle
30. Loosen 5 bolts on Driver's side of vehicle, do NOT remove at this time.
31. Carefully raise the passenger's side of the body. Regularly check and make sure that no lines are over-extended.
32. Insert body lift blocks at 6 places shown Figure 17.

Step 32 Note:

Driver's side is shown in the figure, same locations apply on the passenger's side.



Figure 17

33. Apply supplied Loctite to threads and loosely attach body to frame on passenger's side with 5 new 14mm x 160mm bolts. The front mount uses a 1/2" x 6-1/2" bolt, washers and nuts. Do NOT tighten at this time.
34. Remove 5 remaining bolts from driver's side.
35. Slowly and carefully lift driver's side until 2" blocks are able to be slid in.
36. Apply supplied Loctite to threads and install new 14mm x 160mm bolts in rear 5 locations. Install 1/2" x 6-1/2" bolt with washers and nut in front position.
37. Tighten all body mounting bolts to 55 ft-lbs.
38. Mark line as indicated Figure 18 on metal front bumper. Cut tabs from steel bumper. Only cut the tabs that are on the lower side of the bumper, these tabs have the welded nuts.

Steps 33-36 Note:

All body mount hardware is located in hardware pack #258.



Figure 18

39. Place 9/16" bolt through front bumper as shown Figure 19

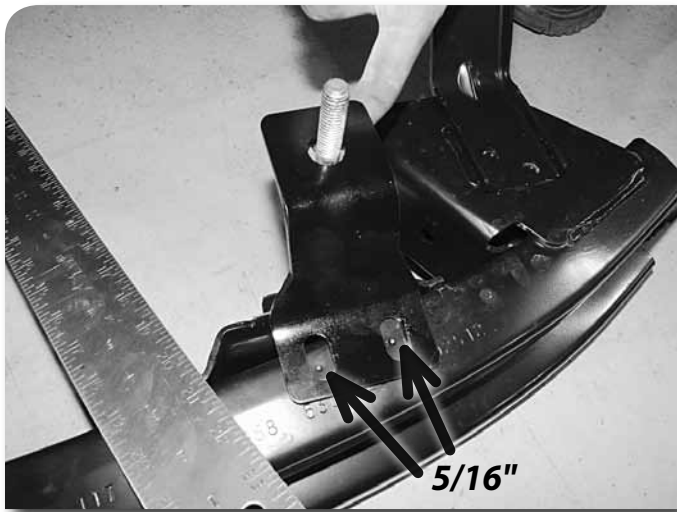

Figure 19

40. Position the provided front bumper bracket as shown with 9/16" bolt going through the center of the hole. Mark the center of the slots on the flat portion of the bumper.
41. Drill these holes to 5/16" and thread in the 3/8" x 1" self tapping bolts. Do NOT tighten at this time.
42. Install metal bumper with the provided 2" steel spacers on top of frame mounting position Figure 20.

Steps 39-43 Note:

Hardware for the front bumper installation is located in hardware pack #256.

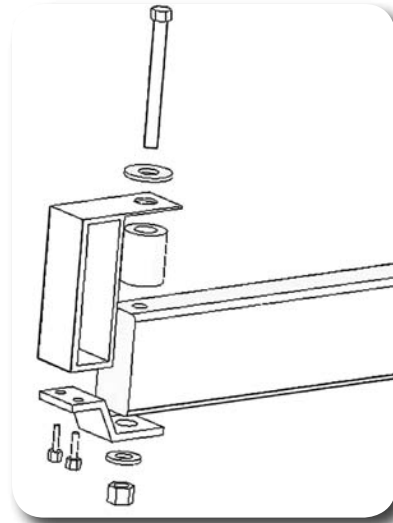

Figure 20

43. Install 9/16" x 7-1/2" bolt through assembly with washers and nuts. Adjust lower bracket as necessary, tighten 3/8" hardware to 25 ft-lbs, tighten 9/16" hardware to 95 ft-lbs
44. Cut welds and remove frame rail mounting brackets from rear bumper Figures 21 & 22 grind flush.



Figure 21

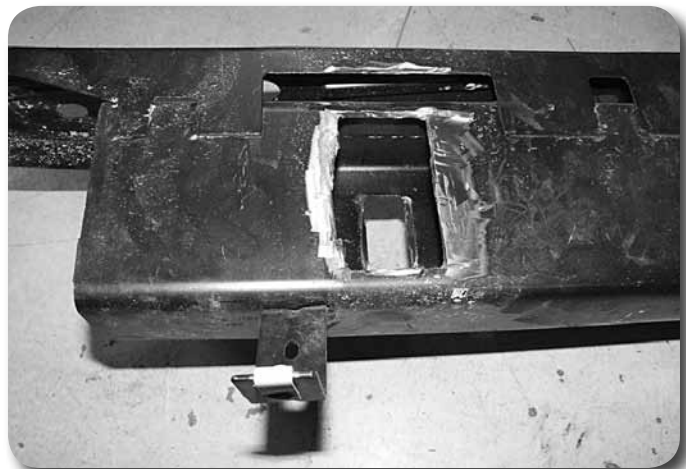

Figure 22

45. Place new relocation brackets onto bumper as shown Figure 23. The brackets are side specific and will mount to the bumper so that 'C' shapes are open toward each other when installed on the bumper.

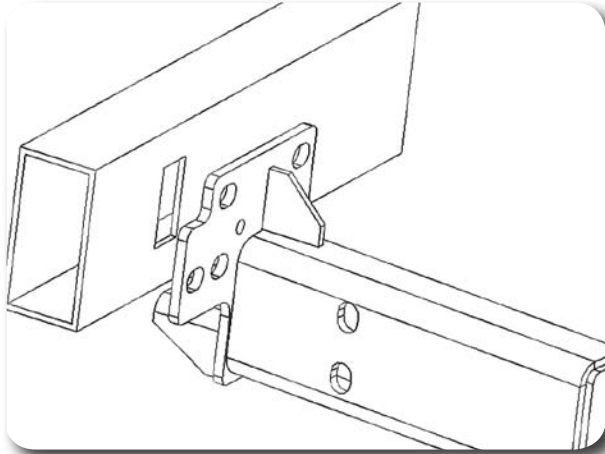

Figure 23

46. Clamp the brackets in place. Check the measurement from outside to outside, compare to frame pocket width. If dimensions are equal, mark the center of the slots and drill to $\frac{1}{2}$ ". If not adjust location until bracket will fit.
47. Install $\frac{1}{2}$ " x 1- $\frac{1}{4}$ " bolts. It will be easiest to install from inside the bumper out (as shown in figure). Leave hardware loose. Figure 24

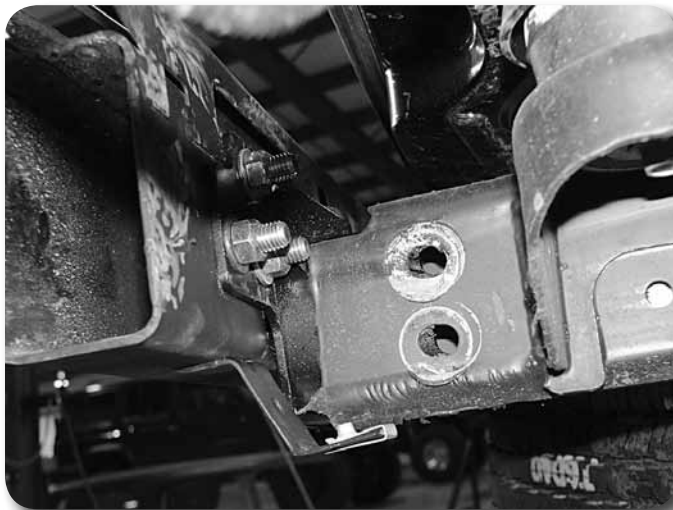

Figure 24

48. Drill center of bottom mounts to $\frac{5}{16}$ ". Attach brackets to bumper with $\frac{3}{8}$ " x 1 self-tapping bolts. Leave hardware loose.
49. Reinstall bumper with new relocation brackets.
50. Attach lower mounting holes with $\frac{9}{16}$ " x 1- $\frac{1}{4}$ " bolts. Do not tighten at this time.
51. Attach side mounting holes with $\frac{1}{2}$ " x 1- $\frac{1}{4}$ " bolts, nuts and washers. Run bolts from outside frame rail to inside.
52. Check the metal bumper to make sure it is level, square and spacing on driver's and passenger's side is equal. Adjust if necessary.
53. Tighten $\frac{3}{8}$ " hardware to 25 ft-lbs, $\frac{1}{2}$ " hardware to 65 ft-lbs and $\frac{9}{16}$ " hardware to 95 ft-lbs.

Step 45 Notes:

The bottom of the bracket will be flush to the bottom of the bumper. The small round location hole in the bracket should be centered on the edge of the rectangular slot in the bumper.

Steps 47-53 Note:

Hardware for the rear bumper bracket installation is located in hardware pack #257.

54. Flip the front tow hooks upside down to mount to opposite side frame rail. Align tow hook on outside of frame rail to mark new hole center to be drilled. Orientate the tow hook so that the rear hole will be slightly above the front hole, about 1/2" higher than the front. The tow hook with angle down. Drill 1/2" holes on frame side with only 1 mounting hole as shown. This will allow the tow hooks to be flipped and reused. **Figure 25**

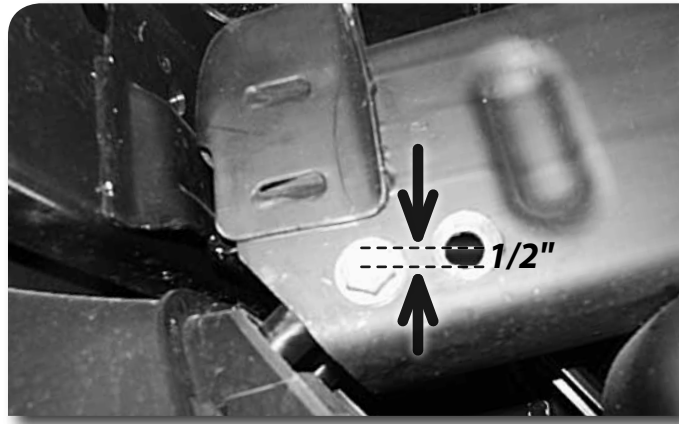

Figure 25

55. Install tow hooks with OE hardware, such that they are flipped over from the OE setup.
56. Grind off / cut inside of plastic bumper cover for clearance. Reference **Figure 4**. Approximately 1/2" will be removed.
57. Reinstall front bumper cover. Reinstall all mounting hardware and clips. *See previous figures.*
58. Reinstall rear bumper cover with OE mounting hardware and clips
59. Position emergency brake relocation bracket as shown in figure. Mark hole centers and drill to 3/8" **Figure 26**.



Figure 26

Step 60 Note:

Hardware for brake line bracket is located in hardware pack #256

60. Install emergency brakeline into brakeline bracket. Attach the bracket to the body mount with the provided 3/8" x 1-1/4" bolts, nuts and washers. Tighten 3/8" hardware to 30 ft-lbs. Reconnect front half of emergency brake cable to back half. Double check brake cable tension and adjust as necessary.
61. Reconnect steering linkage above rack and pinion. Tighten hardware to 30 ft-lbs
62. Reinstall front splash guard with factory hardware.
63. Reconnect battery.

64. Recheck all fasteners after 500 miles and at regularly scheduled maintenance intervals.

Strut Spacer Installation

65. Pack the vehicle on a clean, flat surface and block the rear wheels for safety.
66. Raise the front of the vehicle and support the frame rails with jack stands.
67. Remove the front wheels.
68. Disconnect the front driver's and passenger's side sway bar links from the sway bar. Save hardware. **Figure 27**



Figure 27

Perform the following installation steps on one side at a time.

69. Loosen but do not remove the three upper strut mount nuts at the frame. **Figure 28** Do not loose the center strut rod nut.



Figure 28

70. Remove the nut from the steering tie rod end. **Figure 29** Thread the nut back on a couple of turns by hand. Strike the knuckle near the tie rod end to dislodge the rod end taper from the knuckle. Remove the nut and the tie rod end from the knuckle. Save nut.

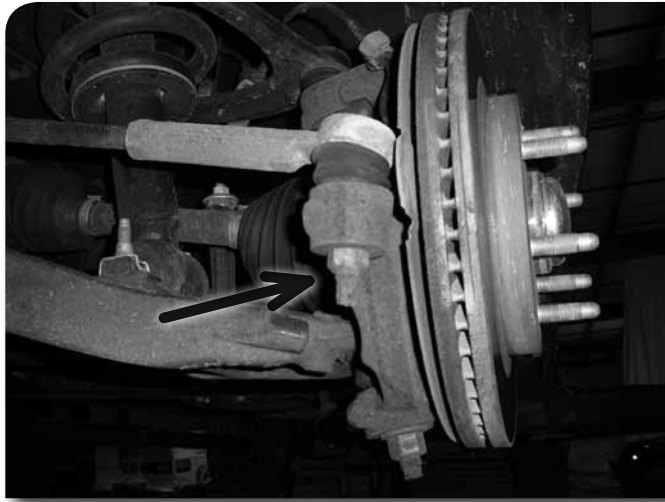

Figure 29

71. Remove the nut from the upper ball joint. **Figure 30** Thread the nut back on a couple of turns by hand. Strike the knuckle near the upper ball joint to dislodge the rod end taper from the knuckle. Remove the nut and allow the knuckle to swing rearward out of the way. Save the ball joint nut.



Figure 30

72. Support the lower control arm with a jack. Remove the two lower strut bar pin bolts. **Figure 31** The bolts will not be reused. Lower the control arm with the jack so there is about 1" of room between the strut bar pin and the lower control arm.



Figure 31

73. Using a flat head screw driver, remove the factory nut clips from the strut bar pins. **Figure 32** These will not be reused.



Figure 32

74. Locate one of the new provided strut mount spacers. Position the spacer between the strut bar pin and the control arm. The small tabs on the spacer will point up and be positioned on the outside of the strut bar pin. The "U" shaped portion of the spacer will wrap down around the backside of the control arm mount.
75. Align the holes in the strut bar pin and the spacer. Install the provided 7/16" x 3-1/2" bolts with washers down through the bar pin and spacer. **Figure 33** Once the bolts are in position, align them with the holes in the control arm and raise the control arm up to seat the assembly together. Fasten the 7/16" bolts with the provided nuts and washers. Torque the 7/16" hardware to 45 ft-lbs.

Step 75 Note

The bolts must run from the top down. All hardware is located in pack #646.



Figure 33

76. With the lower hardware tight. Torque the factory upper strut mount nuts to 40 ft-lbs.
77. Reattach the upper ball joint to the knuckle. Use the jack to support the lower control arm and torque the upper ball joint nut to 40 ft-lbs.
78. Reattach the steering to the knuckle and torque the factory nut to 44 ft-lbs.
79. Repeat installation on the opposite side of the vehicle. When both sides are complete, reattach the sway bar links and tighten hardware until the bushings begin to swell.
80. Reinstall the wheels and lower the vehicle to the ground. Torque lug nuts to 140 ft-lbs in a crossing pattern.
81. Check all hardware for proper torque.
82. Check hardware after 500 miles.
83. Adjust headlights.
84. The vehicle will need a complete front end alignment.

FRONT TRIMMING INSTRUCTIONS

»» THE FOLLOWING IS REQUIRED IF RUNNING 33" TIRES

85. Running a 305/55 R20 tire on stock wheels requires front inner fenderwell modification. Do not use this tire size on wheels with less than 5.5" of backspacing. These are the steps to gain adequate clearance.
86. Park vehicle on clean, flat, and level surface. Block the rear wheels for safety. Safely raise the front of the vehicle and support frame rails with jackstands.
87. Remove front wheels.
88. Remove the front lower plastic valance, this will not be reinstalled due to tire clearance issues.
89. Remove the lower plastic fenderwell mounting bracket. Retain all fasteners.

Figure 34



Figure 34

90. Remove 2" from the edge that is closest to the tire. Figure 35

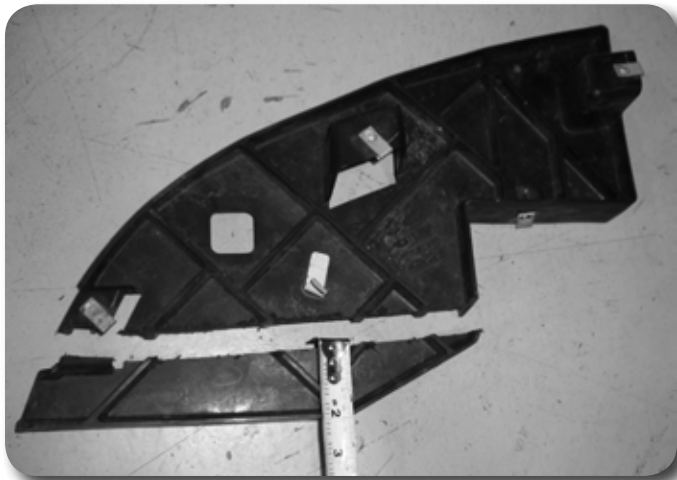

Figure 35

91. Place 'L' shaped bracket up next to the edge, drill 5/16" hole through the plastic bracket, and attach with 1/4" hardware (BP #770), the fender washer will go against the plastic.
92. Reinstall the plastic fender well bracket into the vehicle with OE bolts.
93. Several inches up, slice the inner fenderwell so that it can overlap the front bumper cover. Figure 36
94. Drill 5/16" hole through the inner fenderwell to attach to the 'L' shaped bracket. Use 1/4" hardware with a fender washer against the inner fender well.
95. The very bottom edge of the plastic bumper cover will need to be trimmed as shown. Figure 36



Figure 36

Post-Installation Warnings

1. Check all fasteners for proper torque. Check to ensure for adequate clearance between all rotating, mobile, fixed, and heated members. Verify clearance between exhaust and brake lines, fuel lines, fuel tank, floor boards and wiring harness. Check steering gear for clearance. Test and inspect brake system.
2. Perform steering sweep to ensure front brake hoses have adequate slack and do not contact any rotating, mobile or heated members. Inspect rear brake hoses at full extension for adequate slack. Failure to perform hose check/replacement may result in component failure. Longer replacement hoses, if needed can be purchased from a local parts supplier.
3. Perform head light check and adjustment.
4. Re-torque all fasteners after 100 miles. Always inspect fasteners and components during routine servicing.

96. Reinstall wheels, lower the vehicle to the ground.
97. Perform a steering sweep check. On vehicles equipped with running boards, the very front edge may require trimming.