



6" Oval Nerf Bar

Part No. A8212S/B



Fits: 1999 - 2016

Ford F250/350/450/550 Super Duty Crew Cab



CAN FIT IN DIESEL TRUCKS



REMOVE CONTENTS FROM BOX. VERIFY ALL PARTS ARE PRESENT.



READ INSTRUCTIONS CAREFULLY BEFORE STARTING INSTALLATION.

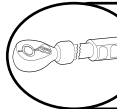

DO NOT OVER TORQUE. STANDARD OPERATING LOAD FOR TIGHTEN BODY MOUNT NUTS & BOLTS VARIES FROM 45 TO 65 FOOT POUND.



60-180 min



Cutting Not Required



Drilling Not Required



support@trailfx.com



1 866 638 4870

POLISHED STAINLESS STEEL – LIMITED LIFETIME
POWDER COATED BLACK – 3 YEARS

PARTS LIST:

Qty	Part Description	Qty	Part Description
1	Driver/Left Sidebar	16	8-1.25mm x 30mm Hex Bolts
1	Passenger/Right Sidebar	8	8-1.25mm x 25mm Hex Bolts
2	Driver/Left Mounting Brackets	32	8mm ID x 24mm OD x 2mm Flat Washers
2	Passenger/Right Mounting Brackets	24	8mm Lock Washers
8	8mm Clip Nuts	8	8mm Hex Nuts

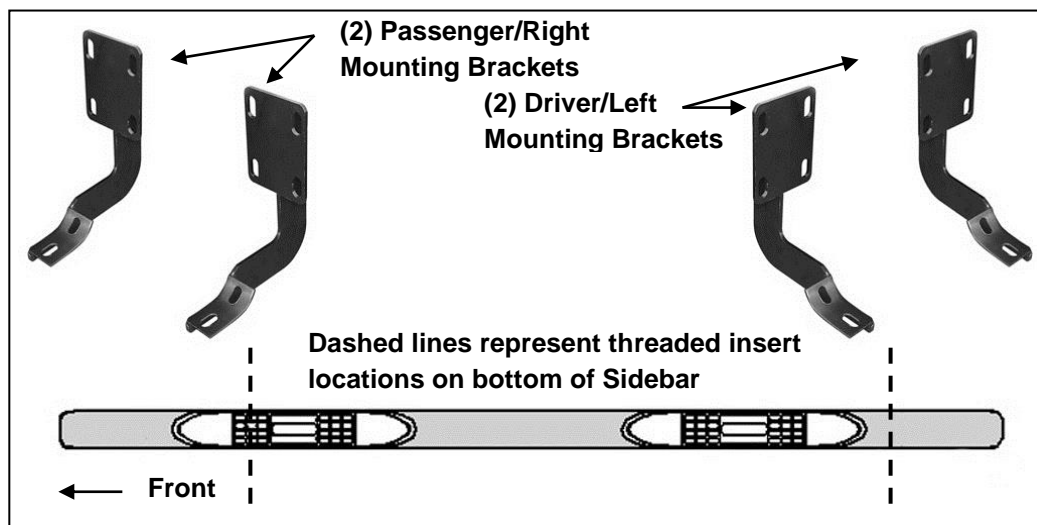

INSTALLATION PROCEDURE:

- Starting on the driver side-front of the vehicle, locate the 2nd set of factory holes in the body panel and pinch weld directly under the center of the front door. Each mounting location comprises of a rectangular hole with a round hole on each side and two holes through the pinch weld, **(Figures 1 & 2)**.
- Select (2) 8mm Clip Nuts. Insert Clip Nuts one at a time into the rectangular opening and slide the threaded hole outward towards the round hole. Line up the threaded hole in the Clip with the round hole next to the rectangular opening. **NOTE:** Threaded nut must go towards the inside of the side panel, **(Figures 1 & 2)**.
- Partially attach the passenger side front Mounting Bracket to the Clip Nuts using the included (2) 8mm x 30mm Hex Bolts, (2) 8mm Lock Washers and (2) 8mm Flat Washers, **(Figure 3)**. **NOTE:** Cradles on the Mounting Brackets should face the front of the vehicle.
- Bolt the (2) bottom holes in the Mounting Bracket to the (2) holes in the pinch weld using the included (2) 8mm x 30mm Hex Bolts, (2) 8mm Lock Washers, (4) 8mm Flat Washers and (2) 8mm Hex Nuts, **(Figure 3)**. Do not tighten hardware at this time.

5. Repeat **Steps 2 – 5** for rear Mounting Bracket installation. **NOTE:** If you're not sure which sets of mounting holes to use, (last set along cab), hold the driver Sidebar up in the approximate location and line up the threaded inserts on the Sidebar with the holes in the pinch weld to determine the correct mounting location.
6. Carefully unwrap and position the Sidebar onto the (2) Mounting Brackets. Bolt the Sidebar to the Brackets with (4) 8mm x 25mm Hex Bolts, (4) 8mm Lock Washers, and (4) 8mm Flat Washers, (**Figures 3 & 4**). Do not tighten at this time.
7. Level and adjust Sidebar properly and tighten all hardware.
8. Repeat **Steps 2 – 8** for passenger Sidebar installation.
9. Do periodic inspections to the installation to make sure that all hardware is secure and tight.

Passenger Side Installation Pictured

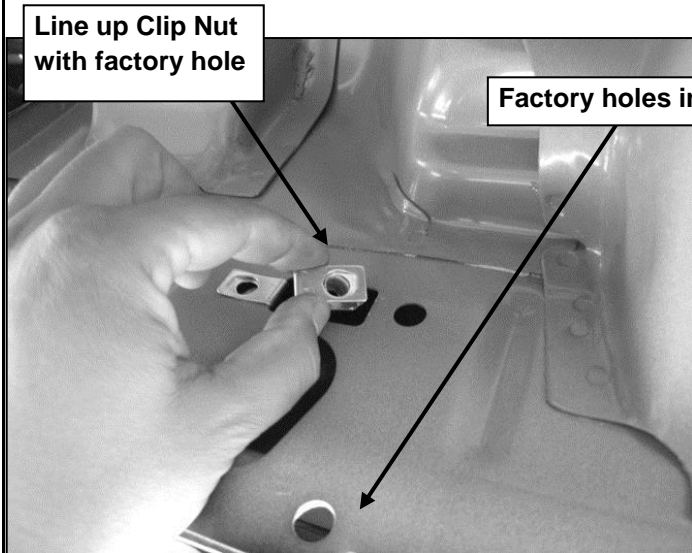

Line up Clip Nut with factory hole

Factory holes in pinch weld

(Fig 1) Typical Mounting Location

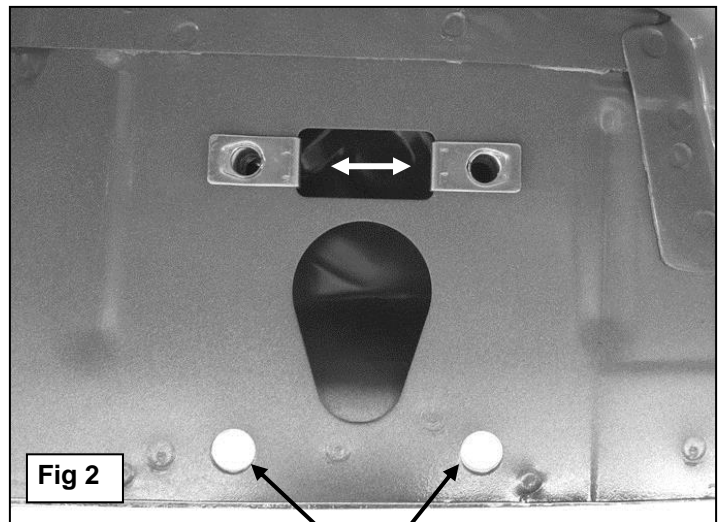
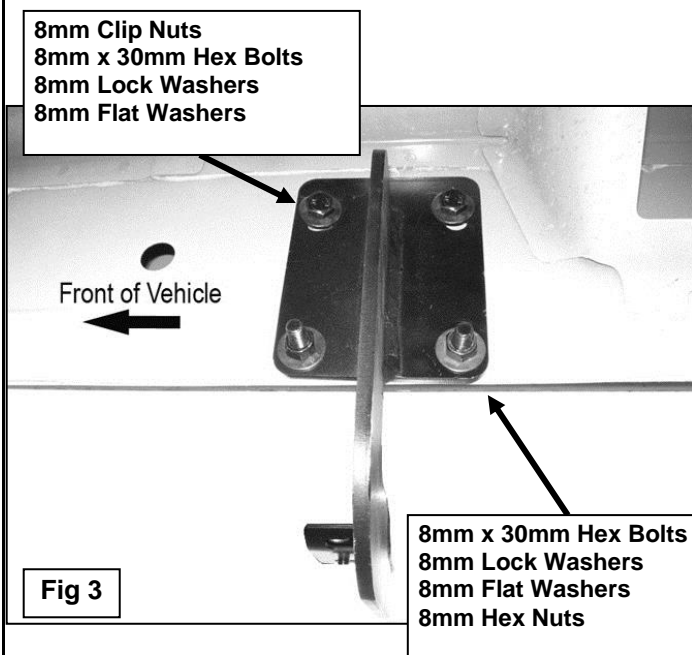

Fig 2

Factory holes in pinch weld



8mm Clip Nuts
8mm x 30mm Hex Bolts
8mm Lock Washers
8mm Flat Washers

Front of Vehicle

8mm x 30mm Hex Bolts
8mm Lock Washers
8mm Flat Washers
8mm Hex Nuts

Fig 3

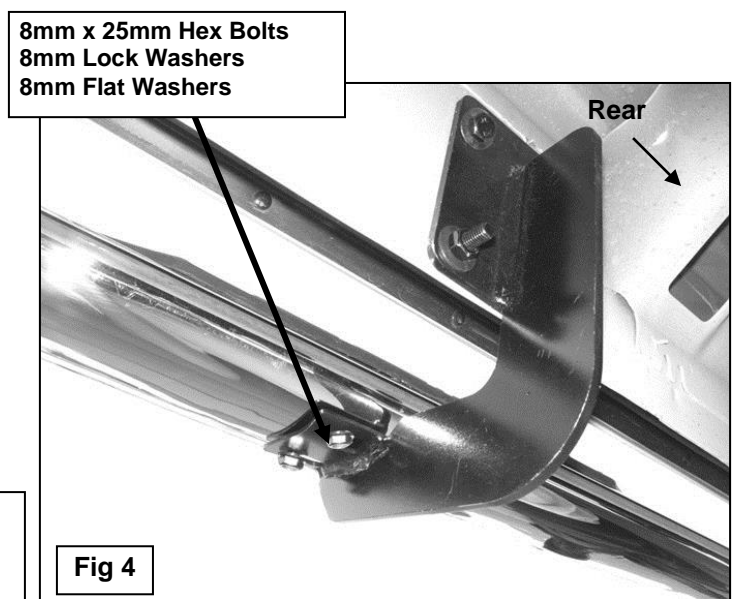

8mm x 25mm Hex Bolts
8mm Lock Washers
8mm Flat Washers

Rear

Fig 4

PARTS IDENTIFICATION GUIDE

Driver Side tube packed using "Green" color foam sheet. Passenger Side tube packed using "White" color foam sheet

No.	Parts Identification
1	Passenger / Right 'Rear' Bracket marked "PR"
2	Driver / Left 'Rear' Bracket marked "DR"
3	Passenger / Right 'Center' Bracket marked "PC"
4	Driver / Left 'Center' Bracket marked "DC"
5	Passenger / Right 'Front' Bracket marked "PF"
6	Driver / Left 'Front' Bracket marked "DF"

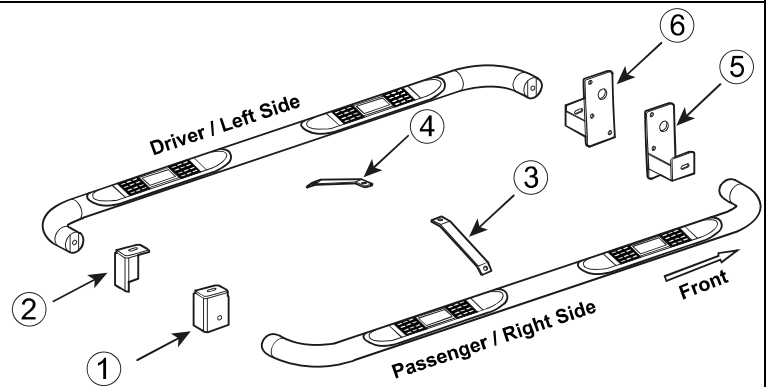
**Note:**

- This guide is to identify the parts and not a reference for part count.
- For part count, refer Parts List.
- Product / Bracket image is representative and actual design may vary.

PRODUCT CARE

- Periodically check the product to ensure all fasteners are tight and components are intact.
- Regular waxing is recommended to protect the finish of the product.
- **Use ONLY Non-Abrasive automotive wax.** Use of any soap, polish or wax that contains an abrasive is detrimental and can scratch the finish leading to corrosion.
- Aluminum polish may be used to polish small scratches and scuffs for **Stainless Steel finish.**
- Mild soap may be used to clean the product for both **Stainless Steel and Black finish.**

FAQ's**1. Hardware's are not of correct size.**

In GMC / Chevrolet truck model 2006 & up, customer needs to reuse the factory body bolts to install the bracket. If your vehicle is not GMC / Chevrolet 2006 & up, ensure that holes are not partially covered with any plastic grommet or rust? If it is, remove the plastic grommet & rust from the thread holes & re-try the installation.

2. Mounting Bracket are not getting Installed properly.

In some cases Illustration images shown in Installation manual may not be the exactly same as per actual vehicle images ,also if Driver / Passenger side mounting brackets are very identical in the design, suggest referring Parts Identification guide to avoid fitment issue.

3. Products are thumping / rattling after installation.

Ensure that all required mounting brackets / hardware's are installed & tighten correctly. Suggest using white lithium / regular grease between the metal to metal contact surfaces.

4. Side Bar is not aligning with vehicle / Step Pads are not aligning with vehicle doors.

Side bar may be interchanged or mounting brackets are not installed at the correct position in the vehicle. Refer Parts identification guide.

5. Missing / Excess Hardware.

Recheck hardware count as per the part list.

6. Product not installing properly.

Ensure make model year, cab length and bed size of your vehicle is listed in the application. All installation steps are followed correctly.

Check out these other TrailFX Products!!

www.TrailFX.com



BULL BAR



GRILLE GUARDS



BED RAILS



RUNNING BOARDS

Keystone Automotive Operations Inc. (KAO) warrants this product to be free of defects in material and workmanship at the time of purchase by the original retail consumer. KAO disclaims any other warranties, express or implied, including the warranty of fitness for a particular purpose or an intended use. If the product is found to be defective, KAO may replace or repair the product at our option, when the product is returned prepaid, with proof of purchase. Alteration to, improper installation, or misuse of this product voids the warranty. KAO's liability is limited to repair or replacement of products found to be defective, and specifically excludes liability for any incidental or consequential loss or damage.