



### IMPORTANT! READ THIS FIRST!

Installation of shock absorbers or other suspension components requires special tools and expert knowledge. Accordingly, installation of all BILSTEIN products must be performed by a professional automotive suspension technician.

When replacing other brands, BILSTEIN shock absorbers or other suspension components should always be installed as a set. All BILSTEIN products must only be used for the specific, intended application as indicated in the application guide. **Any use of any BILSTEIN product other than for its intended use may result in serious bodily injury or death.**

Always use a chassis hoist for the installation of BILSTEIN products and make certain that the raised vehicle is securely attached to the hoist and/or supported to prevent the vehicle from slipping, falling, or moving during the installation process.

**If you install any BILSTEIN product without the necessary special tools, expertise, and chassis hoist, you may subject yourself to the risk of serious bodily injury or death.**

BILSTEIN shock absorbers are gas-filled and are highly pressurized.

- Never place any BILSTEIN shock absorbers in a vise or use a clamp on any BILSTEIN shock absorber.
- Never apply heat near any BILSTEIN shock absorber.
- Never attempt to open or repair any BILSTEIN product, in order to prevent **serious bodily injury or death.**

Any attempt to misuse, misapply, modify, or tamper with any BILSTEIN suspension product voids any warranty and **may result in serious bodily injury or death.**

While installing any BILSTEIN product:

- Do not use impact tools for loosening or tightening fasteners, because this may destroy the screw threads.
- Self-locking fasteners must only be used **once!**
- Reuse original equipment components only if they are in good condition, otherwise replace them with new components.
- Never remove the slight film of oil on the shock absorber piston rod and seal.
- All mounting fasteners for shock absorbers and other suspension components must be securely tightened before tension is placed on the suspension system, unless otherwise specified in the manufacturer's service manual or in this instruction.

After installing any BILSTEIN product:

- The suspension caster and camber must be checked and/or adjusted to comply with the vehicle manufacturer's specifications.
- The (load dependent) brake compensator and the anti-lock brake system must be checked and/or reset to comply with the vehicle manufacturer's specifications.
- The headlight aim must be checked and adjusted. Or, if applicable, adaptive headlights must be checked and recalibrated to comply with the vehicle manufacturer's specifications.
- If applicable, any/all Advanced Driver Assistance Systems (ADAS) must be checked and recalibrated to comply with the vehicle manufacturer's specifications.

### **CAUTION for COILOVER TYPE SUSPENSIONS!!!**

**If disassembling a coilover type suspension, refer to the vehicle manufacturer's service manual for proper procedures. The coil spring is preloaded and must be compressed with a spring compressor to release load before the upper mount is disassembled. Failure to follow the vehicle manufacturer's procedures may cause serious injury or death, and may damage the vehicle.**

### **IMPORTANT!!!**

**This BILSTEIN product may or may not be compatible with non-BILSTEIN aftermarket products and/or vehicle modifications. It is the responsibility of the professional automotive suspension technician performing the installation to identify any non-OEM components and/or modifications on the vehicle that may interact with the suspension system. These must be evaluated for any potential physical static or dynamic interference with and/or effect on the function of this BILSTEIN product.**

E-WM05-0000063  
MOUNTING INSTRUCTION



This instruction is for the rear 41-327890 Black Hawk shocks. A bill of materials of the included mounting part kit is shown below.

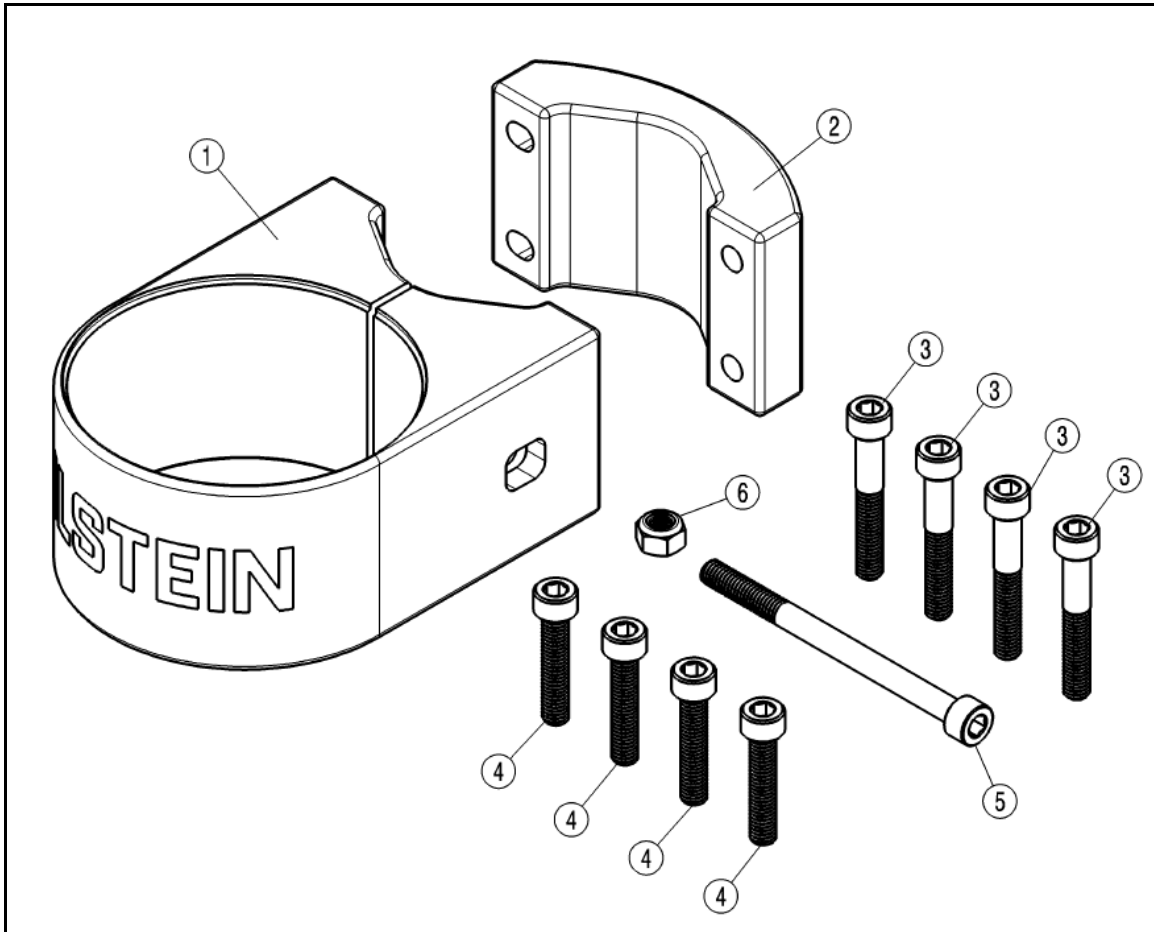

Bill of Materials – REAR		
Item #	Description	Qty
1	Reservoir Clamp	1
2	Roll Cage Bracket	1
3	Socket Head Cap Screw; M6x1; 40mm long	4
4	Socket Head Cap Screw; M6x1; 30mm long	4
5	Socket Head Cap Screw; M6x1; 80mm long	1
6	Nylock Nut; M6x1	1

## **Black Hawk Shock Installation Procedure:**

**NOTE:** The below procedure and images are of the rear right shock unless otherwise stated.

- A. Using a chassis hoist, lift the vehicle off the ground and support the swing arm with jack stands.
- B. Remove the existing shock module from the vehicle following all procedures in the vehicle manufacturer's service manual.
- C. The Black Hawk shocks come pre-set to a specific lift height. After installation, if the pre-set lift height is not what is desired, proceed to the next step and refer to Figure 1 for adjusting the lift height.

### **Rear Lift Height Adjustment Procedure**

- D. Break the lock ring loose from the spring seat with the supplied spanner wrenches. Also, since the spring stops sit against the spring seat, break the spring stops loose if the spring seat is to be moved down (adding pre-load). Refer to the figure below.
- E. Using an appropriate spring compressor, compress the lower spring until it can be rotated freely by hand. Then, spin the spring seat up or down depending on what the desired lift height is (also slide the spring stops down if moving the spring seat down). Moving the spring seat up will reduce the vehicle lift height and down will increase the vehicle lift height. Do not set the spring seat outside the minimum and maximum settings listed below to avoid coil bind under maximum compression and unloading under maximum extension.

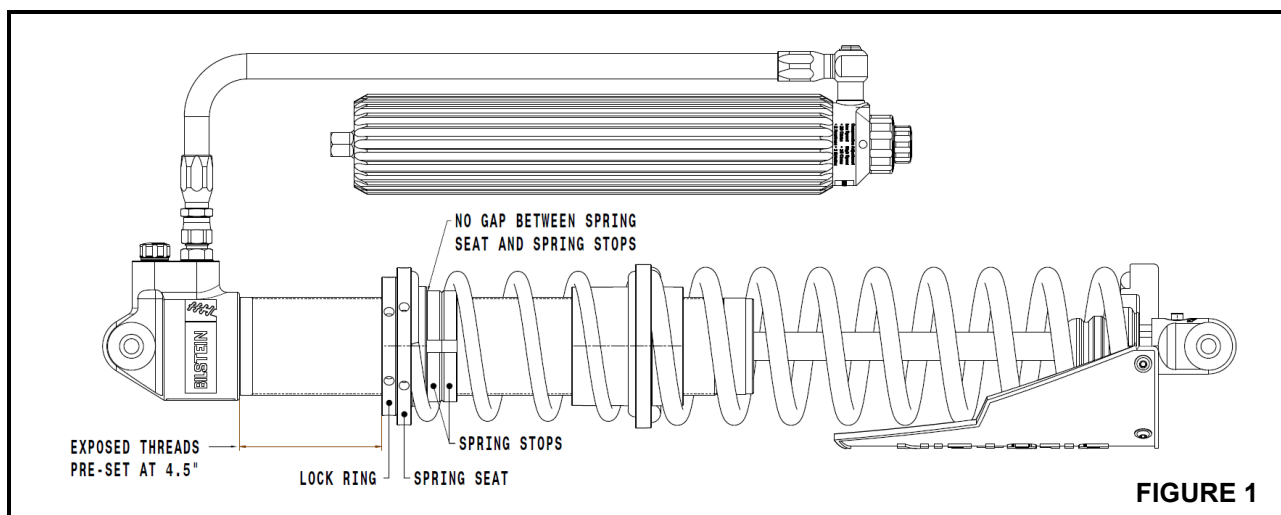

Maximum pre-load setting: 6- $\frac{1}{4}$ " of exposed thread

Minimum pre-load setting: 3- $\frac{3}{4}$ " of exposed thread

- F. Once the desired lift height is set, tighten the lock ring against the spring seat using supplied spanner wrench.

**Torque lock ring to spring seat 37 ft-lb (50 Nm).**

- G. Slowly release the spring compressor.

# E-WM05-000063 MOUNTING INSTRUCTION



## Rear Module Installation Procedure

- H. Heim Spacers and Rubber Washers should come installed on the shocks secured by zip ties. Remove the zip ties prior to installing the shocks on the vehicle. If the Heim Spacers and Rubber Washers have been removed from the Heim Joints, install the Heim Spacers and Rubber Washers onto the upper and lower Heim Joints as shown below.

### UPPER HEIM JOINT

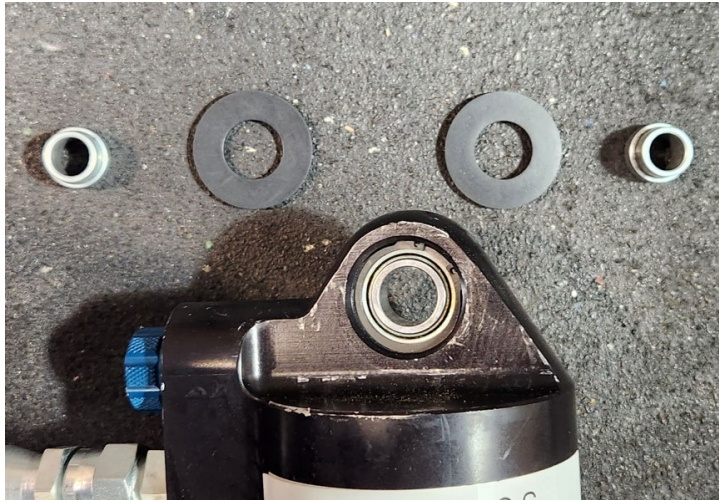

### LOWER HEIM JOINT



# E-WM05-000063 MOUNTING INSTRUCTION



- I. In order to mount the remote reservoirs to the cage, the 2 plastic covers shown below will need to be removed. Using a Torx bit, remove the screws and plastic cover.



- J. After removing the plastic covers, install the shock on the vehicle, feed the remote reservoir up through the opening and place somewhere out of the way for now.



# E-WM05-000063 MOUNTING INSTRUCTION



- K. Using the OE mount bolts and nuts, install the upper and lower mounts of the shock as shown below and hand tighten. Ensure the lower Rod End is mounted so that the Rebound Adjuster is facing towards the rear of the vehicle as shown below to allow access to the Rebound Adjuster.

## UPPER MOUNT



## LOWER MOUNT

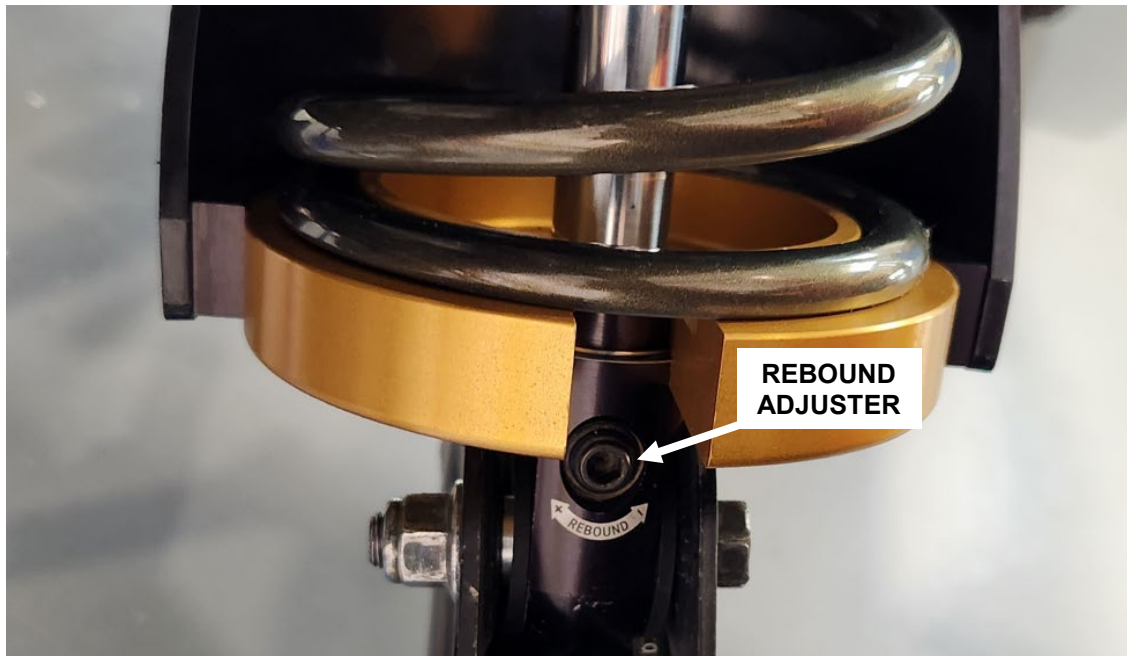

# E-WM05-000063 MOUNTING INSTRUCTION



- L. Once the mount bolts and nuts have been hand-tightened, raise the vehicle so that the full weight is off the suspension and fully extended. Apply non-permanent thread locker and **Torque both upper and lower bolts and nuts to 70 ft-lb (95 N•m).**

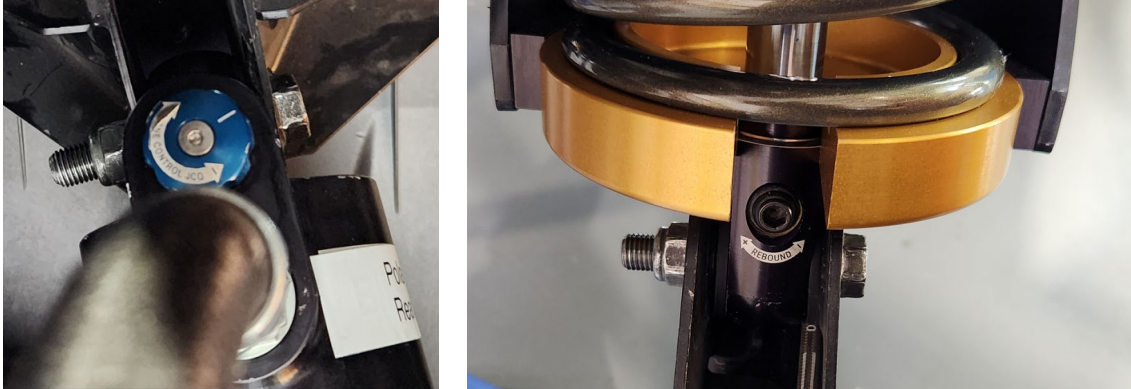

- M. Insert the 80mm long M6x1 Socket Head Cap Screw (BOM Item # 5) into the side hole on the Reservoir Clamp (BOM Item # 1) and thread on the M6x1 Nylock Nut (BOM Item #6) keeping this loose for now.

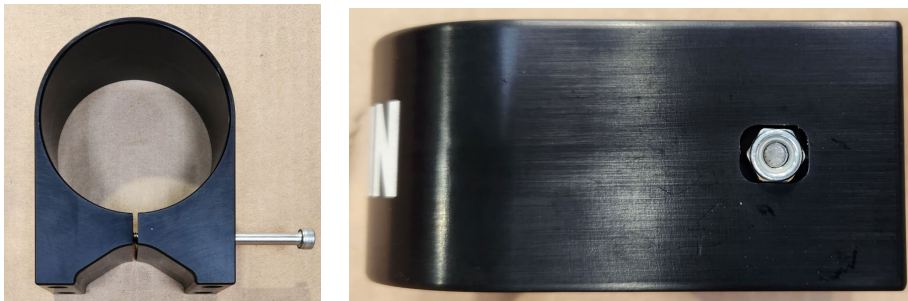

- N. Mount the Reservoir Clamp (BOM Item # 1) and Roll Cage Bracket (BOM Item # 2) using either the 30mm or 40mm long M6x1 Socket Head Cap Screws (BOM Items # 3 and 4) as shown below. Depending on the Roll Cage tubing diameter, you will need to determine which of these screws to use in order to give enough clamping force to secure reservoir to the Roll Cage. Tighten the Socket Head Cap Screws enough to keep in place but loose enough to rotate and slide the bracket around the Roll Cage.

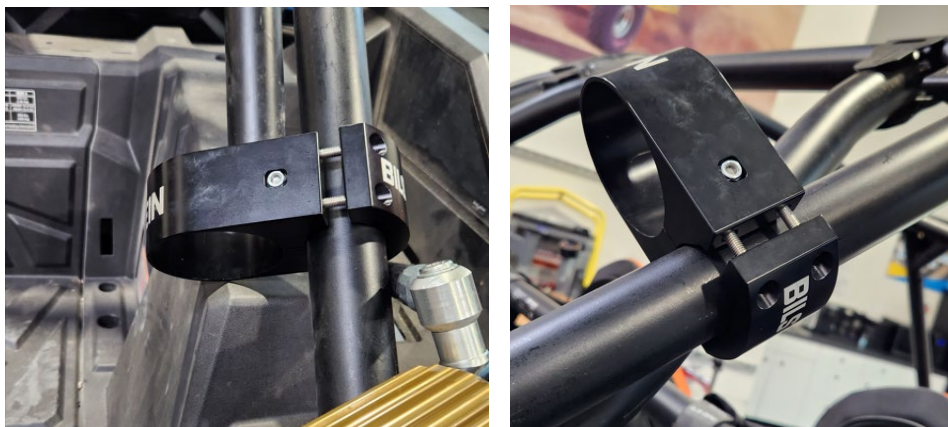

# E-WM05-000063 MOUNTING INSTRUCTION



- O. Slide the reservoir into the Reservoir Clamp (BOM Item #1) as shown below with the adjuster and hose fitting facing toward the rear of the vehicle. The reservoir below is positioned toward the outside of the roll cage. This may need to be adjusted due to various aftermarket cages and aftermarket accessories present on other vehicles.



- P. Position the Reservoir Clamp (BOM Item #1) so that it sits approximately in the middle of the Reservoir. Ensure that the Reservoir Hose is not rubbing anywhere on the open slot where the plastic covers were removed in Step I. Then **torque the 80mm long M6x1 Socket Head Cap Screw (BOM Item # 5) to 6 ft-lb (8 Nm).**

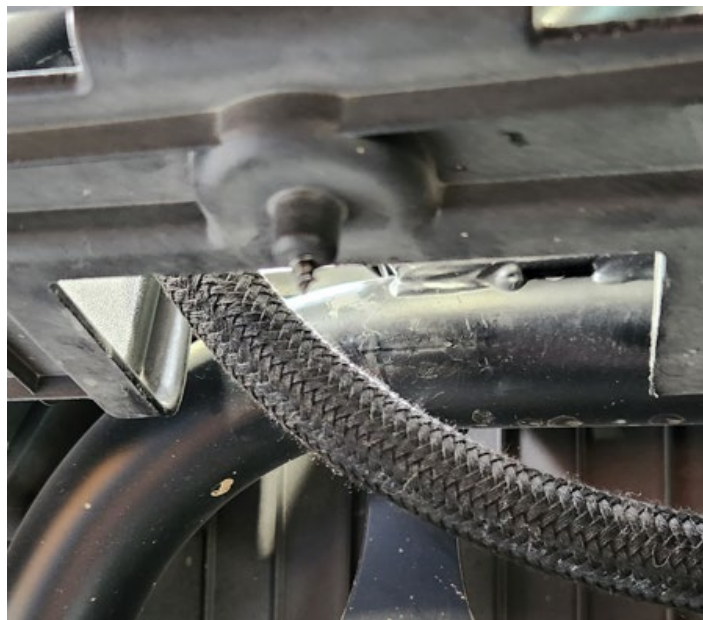



# E-WM05-000063 MOUNTING INSTRUCTION



- Q. Once the reservoir is in the desired position, apply non-permanent thread locker and **torque the four Socket Head Cap Screws to 6 ft-lb (8 N•m)**.



E-WM05-000063  
MOUNTING INSTRUCTION



Final rear 41-327890 Black Hawk shock installed on vehicle:



## Dual Speed Reservoir Adjustment

These dampers come equipped with a high and low speed compression damping adjusters located on the remote reservoir. The high speed adjuster is the blue knob and is labeled as such, and the low speed adjuster is the gold knob and is labeled as such. The **FULL FIRM** setting for each adjuster knob is achieved when the knob is turned all the way **CLOCKWISE**. The **FULL SOFT** setting for each adjuster knob is achieved when the knob is turned all the way **COUNTER-CLOCKWISE**. To make high or low speed adjustments, simply turn each knob individually until the desired level of control is achieved. To stiffen the ride, turn the knobs clockwise. To soften the ride, turn the knobs counter-clockwise.

The factory setting of these adjusters are as follows:

- High Speed (blue knob) – 5 clicks counter-clockwise from fully firm (10 total positions, 1 full rotation)
- Low Speed (gold knob) – 10 clicks counter-clockwise from fully firm (20 total positions, 2 full rotations)



Dual Speed Reservoir Adjuster

## Zone Control JCO (Jounce Cut-off) Adjustment

These dampers also come equipped with an adjuster for the JCO (jounce cut-off) system. This blue adjuster knob is located on the mount cap above the coil spring. The **FULL FIRM** setting for the adjuster knob is achieved when the knob is turned all the way **CLOCKWISE**. The **FULL SOFT** setting for the adjuster knob is achieved when the knob is turned all the way **COUNTER-CLOCKWISE**. To make JCO adjustments, simply turn the adjuster knob clockwise for more bottom out control and counter-clockwise for less bottom out control. The adjustment will not affect the ride quality when the vehicle is in the main damping zone at regular ride height.

The JCO adjuster factory setting is:

- 5 clicks counter-clockwise from fully firm (10 total positions, 1 full rotation)



JCO (Jounce Cut-off) Adjuster

## **Rebound Adjustment**

These dampers come equipped with a rebound damping adjuster located on the rod end. The **FULL FIRM** setting is achieved when the adjuster is turned all the way **CLOCKWISE**. The **FULL SOFT** setting is achieved when the adjuster is turned all the way **COUNTER-CLOCKWISE**. To make adjustments, simply turn the adjuster with a 6mm hex driver until the desired level of control is achieved. To stiffen the ride, turn the adjuster clockwise. To soften the ride, turn the adjuster counter-clockwise.

The rebound adjuster factory setting is:

- 15 clicks counter-clockwise from fully firm  
(15 total positions, 2.5 full rotations)

