



JEEP JL 2.5" SUSPENSION KIT

Thank you for choosing Rough Country for your suspension needs.

Rough Country recommends a certified technician install this system. In addition to these instructions, professional knowledge of disassemble/reassembly procedures as well as post installation checks must be known. Attempts to install this system without this knowledge and expertise may jeopardize the integrity and/or operating safety of the vehicle.

Please read instructions before beginning installation. Check the kit hardware against the parts list. Be sure you have all needed parts and know where they go. Also please review tools needed list and make sure you have needed tools.

PRODUCT USE INFORMATION

⚠ WARNING

As a general rule, the taller a vehicle is, the easier it will roll. Seat belts and shoulder harnesses should be worn at all times. Avoid situations where a side rollover may occur.

Generally, braking performance and capability are decreased when larger/heavier tires and wheels are used. Take this into consideration while driving. Do not add, alter, or fabricate any factory or after-market parts to increase vehicle height over the intended height of the Rough Country product purchased. Mixing component brands is not recommended.

Rough Country makes no claims regarding lifting devices and excludes any and all implied claims. We will not be responsible for any product that is altered.

This suspension system was developed using a 35x12.50x20 tire on a 20x10 wheel with -18 offset. Different wheel and tire combinations may be used but different tire manufactures designs may result in a tire width that could result in contact with the lower control arm and/or front sway bar link in a sharp turn. Please consult with your tire and wheel expert before purchasing. Also note that if wider tires are desired, offset wheels will be required. If question exist we will be happy to answer any questions concerning the design, function, and correct use of our products by calling 1-800-222-7023.

⚠ NOTICE

NOTICE TO DEALER AND VEHICLE OWNER

Any vehicle equipped with any Rough Country product should have a "Warning to Driver" decal installed on the inside of the windshield or on the vehicle's dash. The decal should act as a constant reminder for whoever is operating the vehicle of its unique handling characteristics.

- | |
|--|
| <p>Tools Needed:
6mm Allen
10mm Socket & Wrench
15mm Socket & Wrench
18mm Socket & Wrench
21mm Socket & Wrench
22mm Deep Well Socket
Pliers
9/16" Socket & Wrench
3/4" Socket & Wrench
Jack
Jack Stands</p> |
|--|

Prior to installing this kit, with the vehicle on the ground, measure the heights of your vehicle. This measurement can be recorded from the center of the wheel straight up to the top of the inner fender lip. Record the measurements.

LF: _____ , RF: _____ ,

LR: _____ , RR: _____



KIT CONTENTS

1609BAG6
1609BAG7
1676BAG
79330BAG1
 2 - Front Sway Bar Links
 2 - Rear Sway Bar Links
 2 - Front Coil Spacer
 2 - Rear Coil Spacer
 2 - Front Shock Bracket
 2 - Rear Shock Bracket
 2 - Rear Bump Stop Spacer
 2 - Body Puck

1609BAG6
 4 - 3/8" Flat Washer
 4 - 3/8" x 3/4" Bolt
 4 - 3/8" Flange Locknut

1609BAG7
 2 - 3/8" x 3 1/4" Bolt
 2 - 3/8" Flange Lock Nut
 2 - 3/8" Flat Washer

1676BAG
 2 - 3/8" Flange Locknut
 2 - 1/2" Lock Nut
 2 - 1/2" x 1 1/4" Bolt
 2 - 3/8" Flat Washer
 2 - 3/8" x 1" Bolt
 4 - 12mm Flange Locknut
 4 - 12mm x 65mm Bolt
 2 - 1/2" x 2 1/2" Bolt
 4 - Sleeve
 2 - Spring Washer
 6 - 1/2" Flat Washer

79330BAG1
 2 - 1/2" Flat Washer
 2 - 12mm x 65mm Bolt
 2 - 12mm Flange Lock Nut
 2 - 14mm x 75mm Bolt
 2 - 14mm Lock Nut
 2 - 5/16" Flat Washer
 2 - 3/8" Flat Washer



Torque Specs:

Size	Grade 5	Grade 8	Size	Class 8.8	Class 10.9
5/16"	15 ft/lbs	20ft/lbs	6MM	5ft/lbs	9ft/lbs
3/8"	30 ft/lbs	35ft/lbs	8MM	18ft/lbs	23ft/lbs
7/16"	45 ft/lbs	60ft/lbs	10MM	32ft/lbs	45ft/lbs
1/2"	65 ft/lbs	90ft/lbs	12MM	55ft/lbs	75ft/lbs
9/16"	95 ft/lbs	130ft/lbs	14MM	85ft/lbs	120ft/lbs
5/8"	135ft/lbs	175ft/lbs	16MM	130ft/lbs	165ft/lbs
3/4"	185ft/lbs	280ft/lbs	18MM	170ft/lbs	240ft/lbs



FRONT INSTALLATION INSTRUCTIONS

1. Place vehicle in park and chock the rear wheels. Raise the front of the vehicle with a jack and secure a jack stand beneath each frame rail behind the front control arms. Ease the frame down onto the stands. Place the jack under the front axle for support when removing the coil springs.
2. Remove the front tires/wheels, using a 22mm deep well socket.
3. Mark and remove front driveshaft from axle using a 15mm socket. **Hang the driveshaft up don't let it fall or rest on the driveshaft boot or it could damage the boot.**
4. Using a 21mm socket and wrench, remove the bolt securing the front track bar to the frame. **See Photo 1.** Retain hardware for reuse.
5. Using an 18mm socket and wrench remove the bottom sway bar link bolts. Retain hardware for reuse. **See Photo 2.**
6. Remove the lower shock bolt using a 18mm socket and wrench. You may have to raise the axle with the jack and pull down on the shock to remove the bolt. **See Photo 3.** Retain stock hardware.

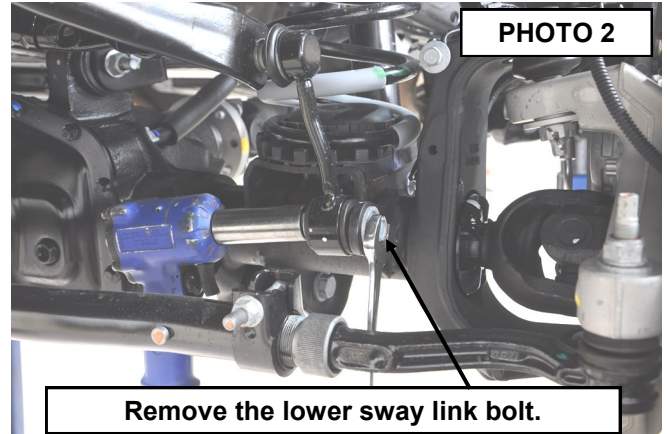
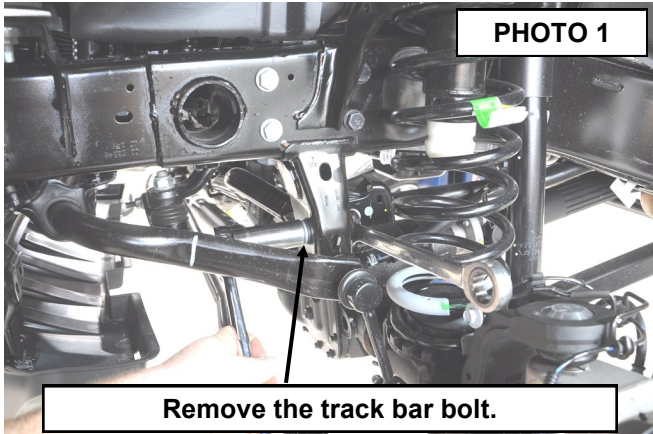

7. Using a 15mm wrench, remove the brake line bracket from the lower control arm. **See Photos 4 & 5.** Retain hardware for reuse.

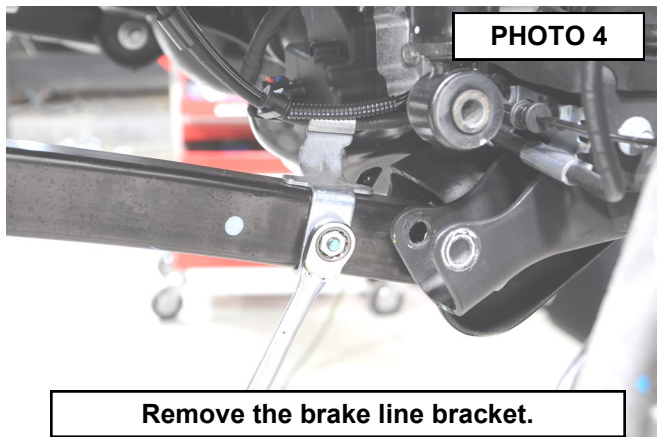
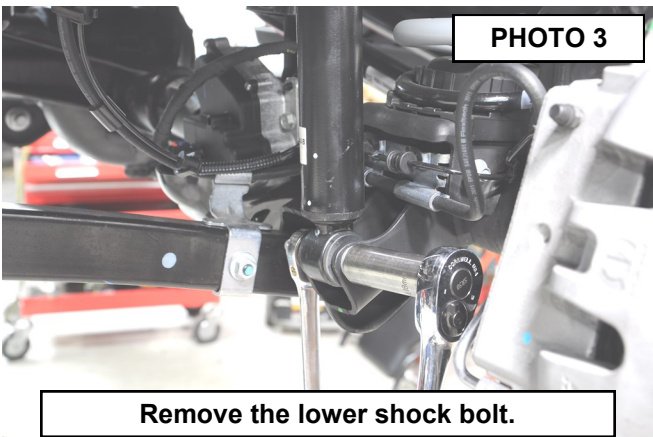

8. Using pliers, remove the wiring harness from the upper control arm. **See Photo 6.**
9. Loosen the upper control arms using a 18mm wrench.

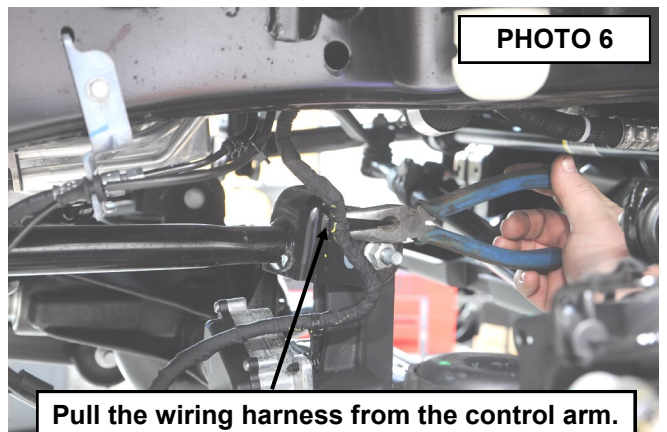
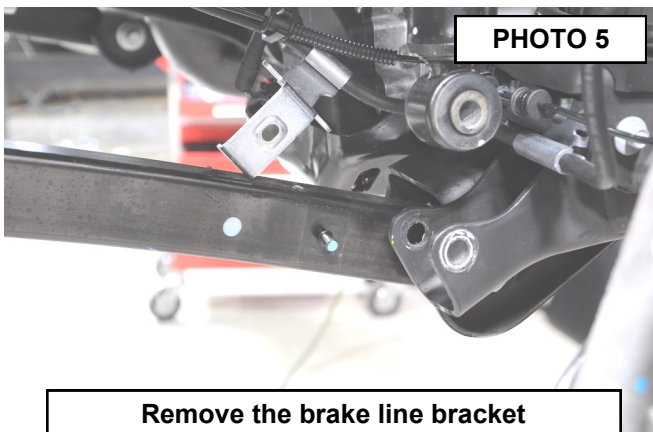

- Using pliers, remove the axle vent tube from the differential housing. **See Photo 7.**
- Unplug the 4x4 actuator for slack. **See Photo 8.**

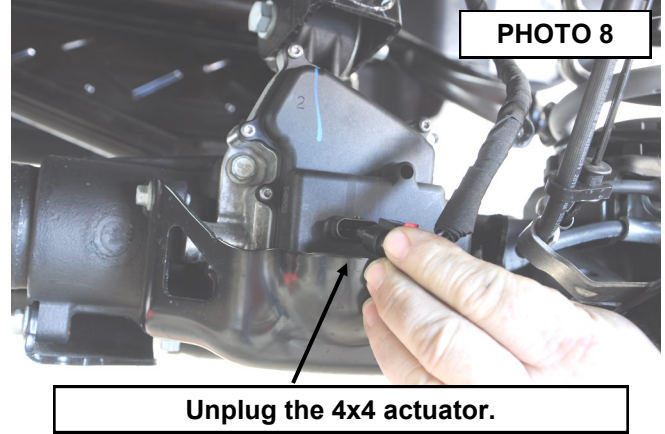
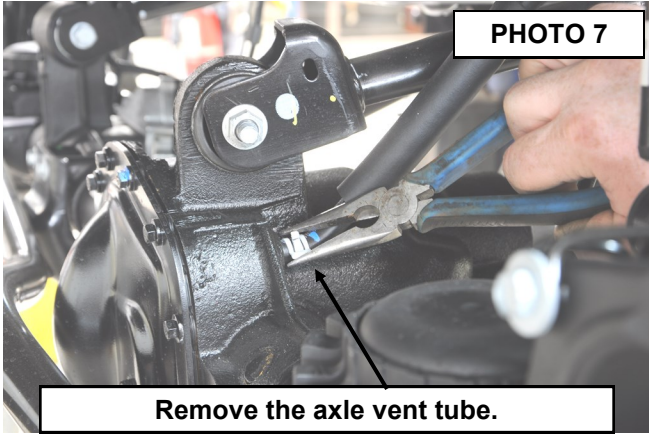

- Lower the jack, careful not to let the axle reach full droop, and remove the coil spring and spring isolator. **See Photo 9.**
- Using a 10mm wrench, remove the brake line bracket from the coil mount. Retain hardware for reuse. **See Photo 10.**

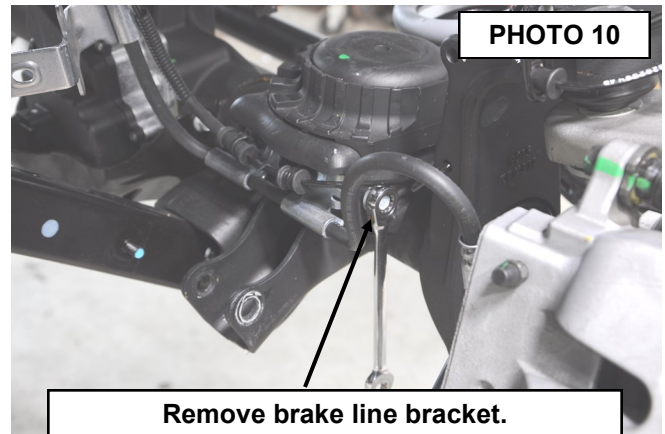
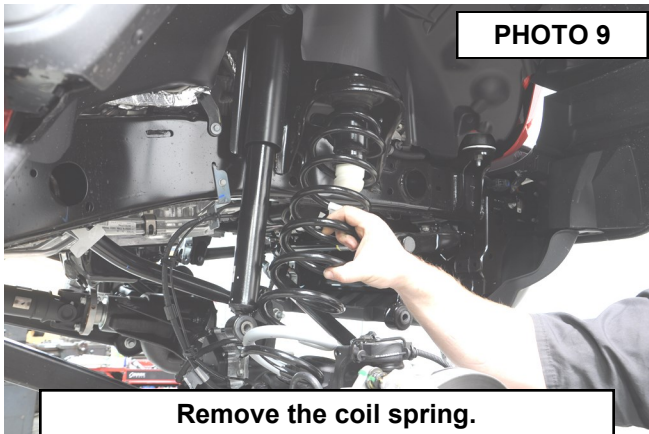

- Install the supplied spring spacer with coil spring isolator under the spacer. **See Photo 11.**
- Install the factory coil spring. **See Photo 12.**

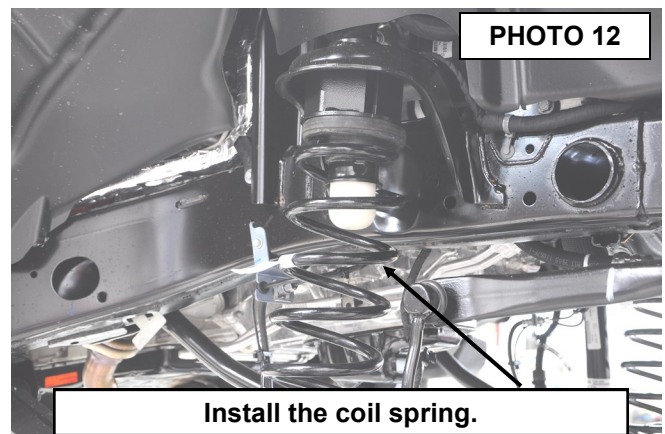
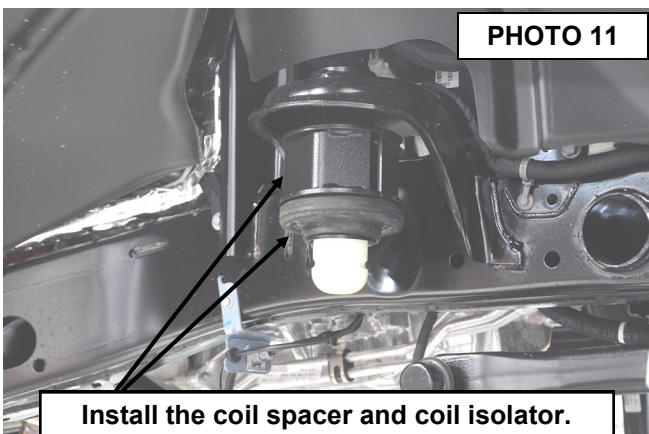

15. Install the bump stop spacer into the lower coil mount. **See Photo 13.**
16. Place the supplied 3/8" x 3" bolt, washers, and nut (1609BAG7) through the spacer and coil mount. **See Photo 14.**

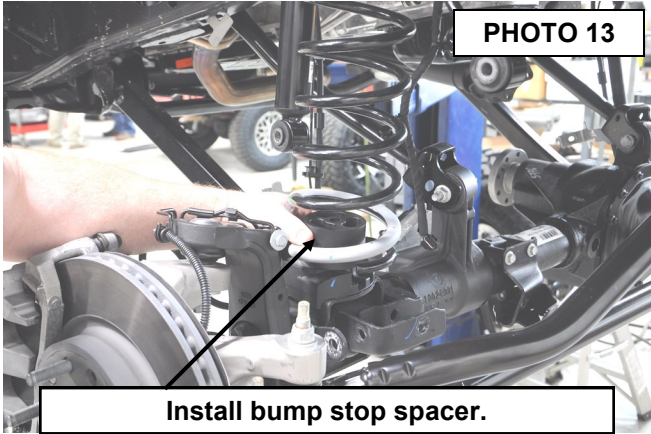

PHOTO 13
Install bump stop spacer.

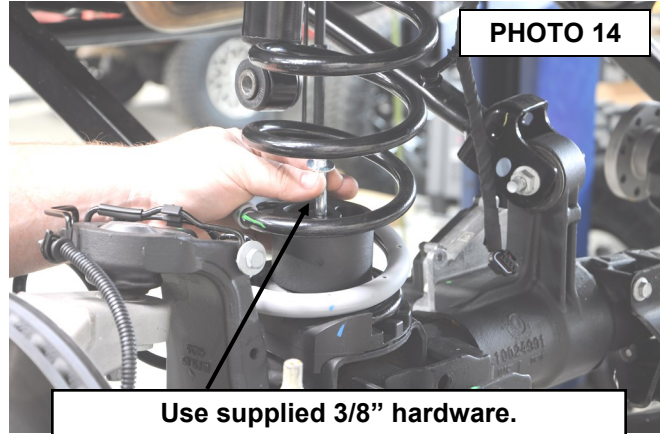

PHOTO 14
Use supplied 3/8" hardware.

17. Tighten using 9/16" wrenches. **See Photo 15.**
18. Install the brake line bracket on the coil mount using the factory hardware and a 10mm wrench.
19. Install the supplied shock extension bracket using the supplied 3/8" x 1" bolt, 3/8 washer, and 3/8" flange locknut (1676BAG), through the bottom hole of the bracket. Do Not Tighten. **See Photo 16.**

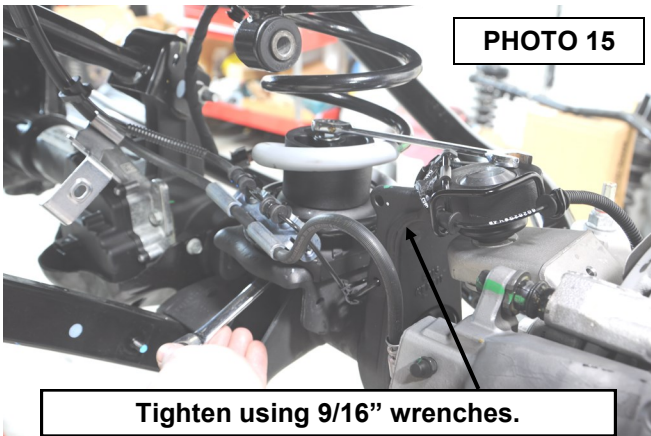

PHOTO 15
Tighten using 9/16" wrenches.

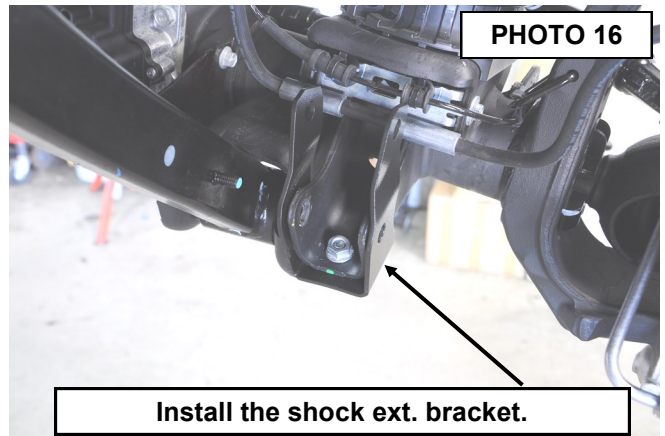

PHOTO 16
Install the shock ext. bracket.

20. Place the supplied crush sleeve (1676BAG) into the factory shock bracket. Install the factory shock hardware into the brackets and through the sleeve. **See Photo 17.**
21. Tighten the lower bolt using a 9/16" socket and wrench. Torque to 30ft/lbs. **See Photo 18.**



PHOTO 17
Install the supplied sleeve.

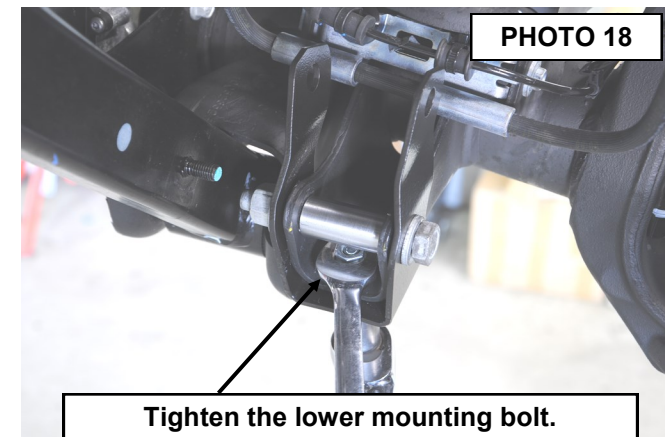
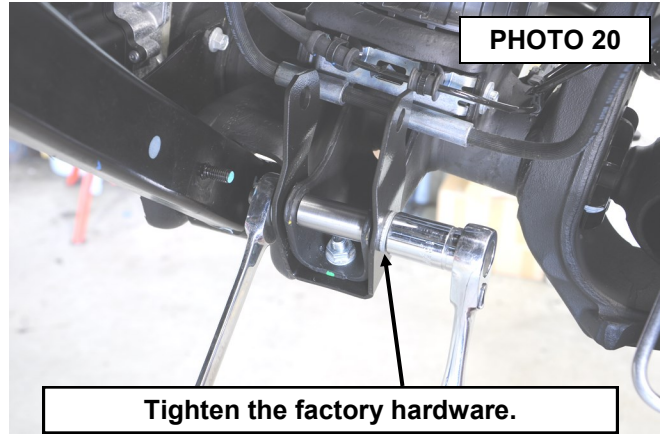
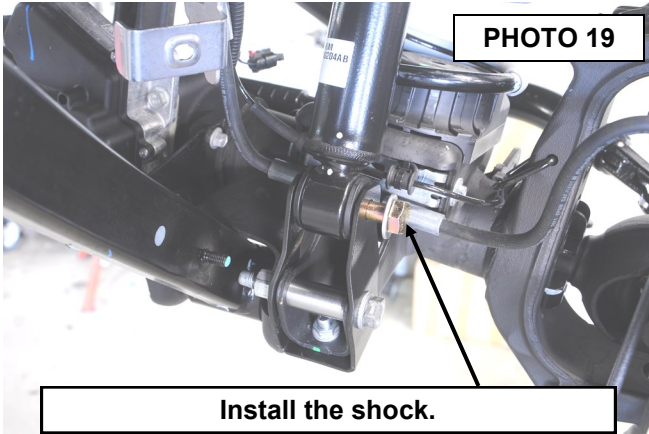
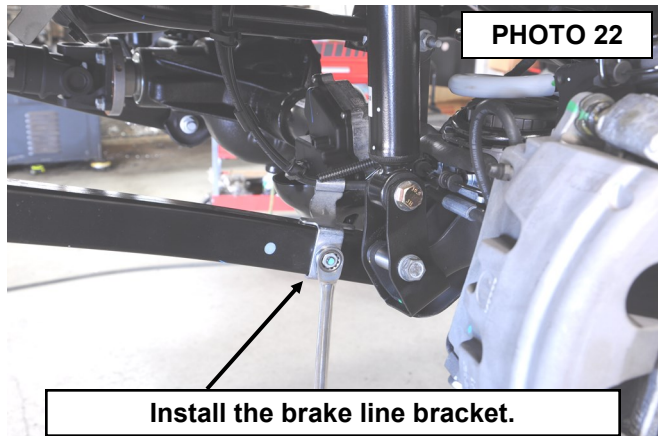
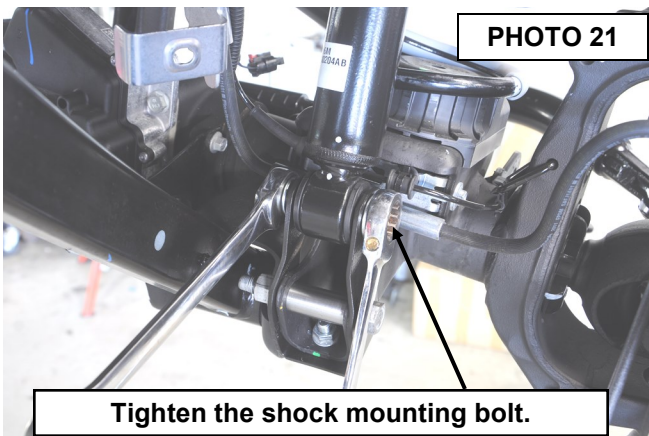

PHOTO 18
Tighten the lower mounting bolt.

22. Using a jack to compress the suspension, install the shock in the extension bracket using the supplied 12mm x 65mm bolt, 1/2" washers, and 12mm nut (1676BAG). **See Photo 19.**
23. Tighten the factory bolt using an 18mm socket and wrench. Torque to 55ft/lbs. **See Photo 20.**



24. Tighten the lower shock bolt using an 18mm socket and wrench. Torque to 55ft/lbs. **See Photo 21.**
25. Install the brake line bracket on the lower control arm using the factory hardware. Tighten using a 15mm wrench. Torque to 18ft/lbs. **See Photo 22.**



26. Remove the sway link from the sway bar using a 6mm Allen and an 18mm wrench. **See Photo 23.**
27. Install the new supplied bent sway link using the supplied 12mm x 65mm bolt, 1/2" washers, and lock nut (79330BAG1). Torque to 55ft/lbs. **See Photo 24.**

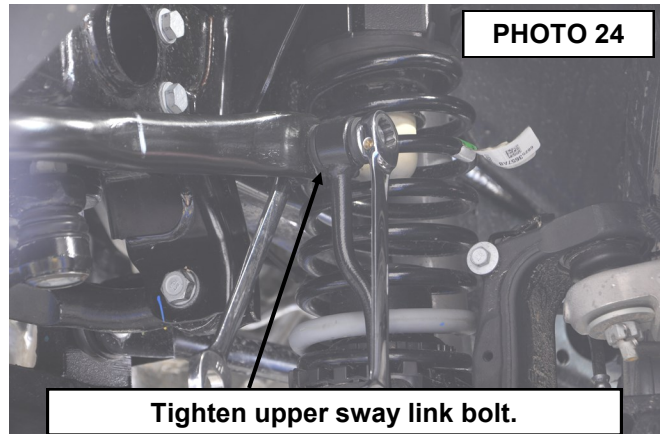
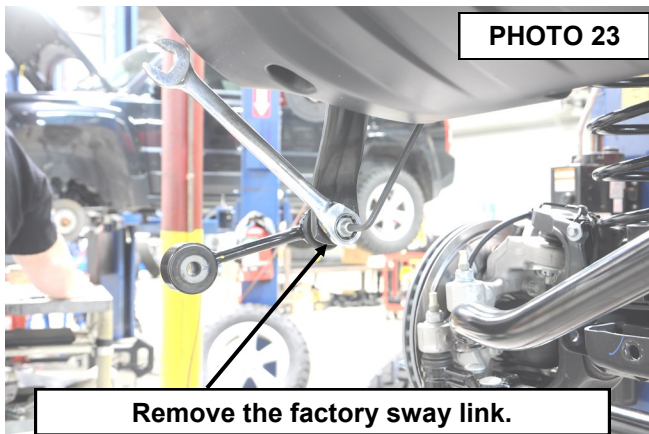

28. Clip the wiring harness into the upper control arm.
29. Attach the axle vent tube to the differential using a pair of pliers.
30. Plug-in the 4x4 actuator. **See Photo 25.**
31. Attach the sway bar links, to the axle, using the factory hardware and an 18mm socket and wrench. Torque to 55t/lbs.
32. Reinstall the front tires/wheels, using a 22mm deep well socket.
33. Lower the vehicle to the floor.
34. Attach the track bar using the factory hardware and a 21mm socket and wrench. Torque to 120ft/lbs. Turning the steering wheel will help align the track bar and the mounting hole.
35. Retighten the lower control arms using a 21mm & 24mm wrench.
36. Retighten the upper control arms using a 18mm wrench.

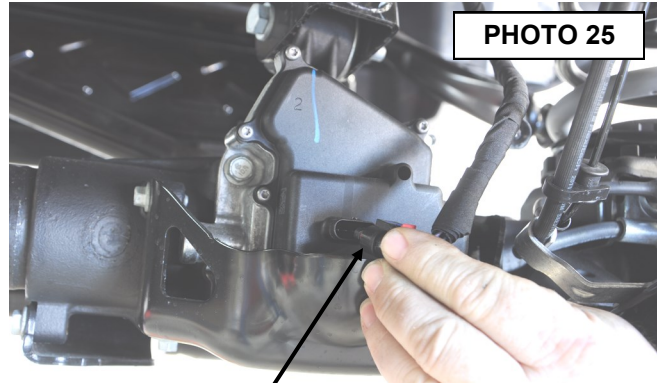
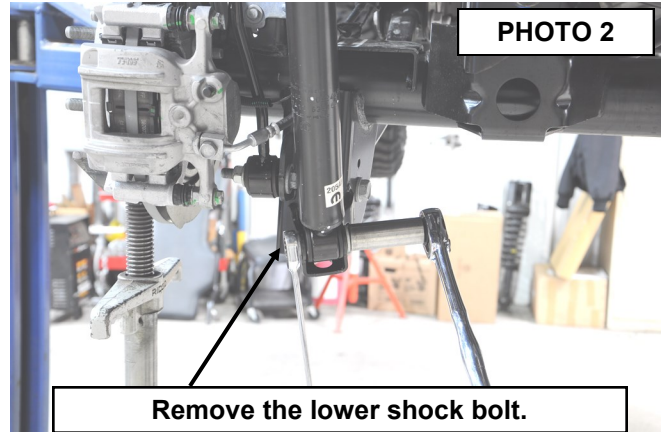
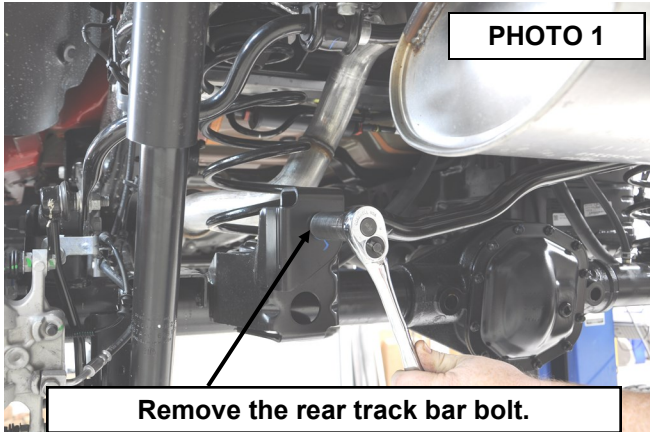

PHOTO 25

Plug in the 4x4 actuator.

REAR INSTALLATION INSTRUCTIONS

1. Jack up the rear of the vehicle and support the vehicle with jack stands, so that the rear wheels are off the ground. Chock front wheels. Position a jack so it supports, but does not raise the rear axle.
2. Remove the rear tires/wheels, using a 22mm deep well socket.
3. Using a 21mm socket remove the track bar bolt at the axle. Retain the stock hardware for reuse. **See Photo 1.**
4. Using an 18mm socket and wrench, remove the lower shock mounting hardware. Save for reuse. **See Photo 2.**



5. Using an 18mm socket and wrench, remove the lower sway bar link hardware. **See Photo 3.**
6. Lower the axle and remove the coil spring and coil spring isolator. **See Photo 4.**

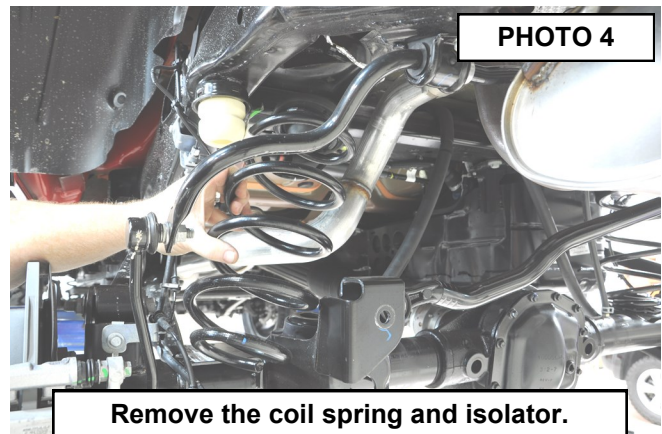
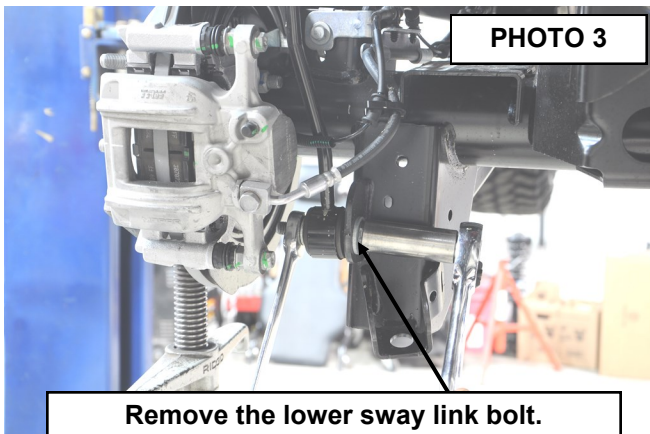

7. Install the supplied bump stop spacer on the axle using the supplied 3/8" x .75" bolts, washers, and flange lock nuts. (You will use 2 bolts, 2 washers, and 2 nuts per side) **See Photo 5.**
8. Using a 9/16" wrench and socket, torque the hardware to 30ft/lbs. **See Photo 6.**

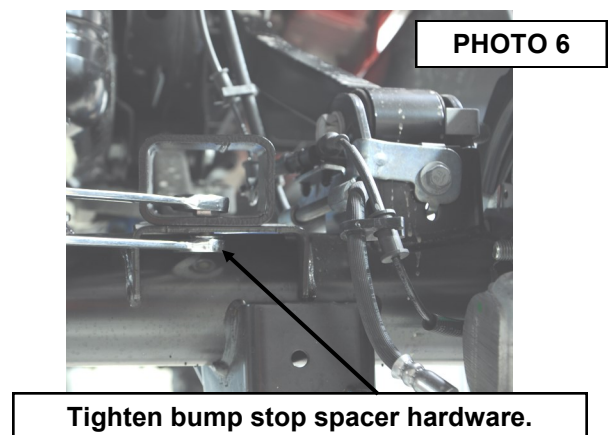
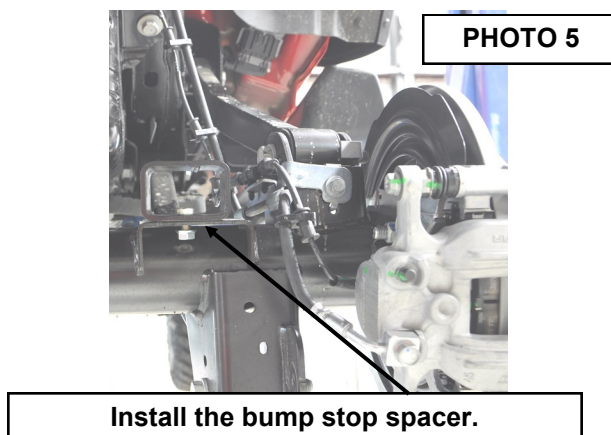

9. Using a 6mm Allen and an 18mm wrench remove the sway link from the sway bar. **See Photo 7.**
10. Attach the supplied straight sway link using the supplied 12mm x 65mm bolt, 12mm washers (bolt head side only), and 12mm flange nut (79330BAG1). **See Photo 8.**

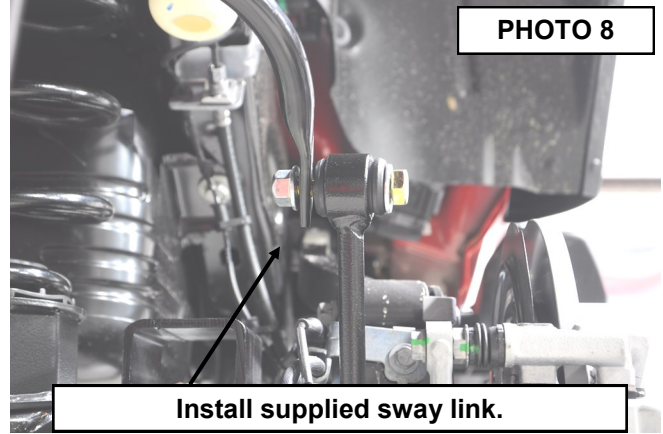
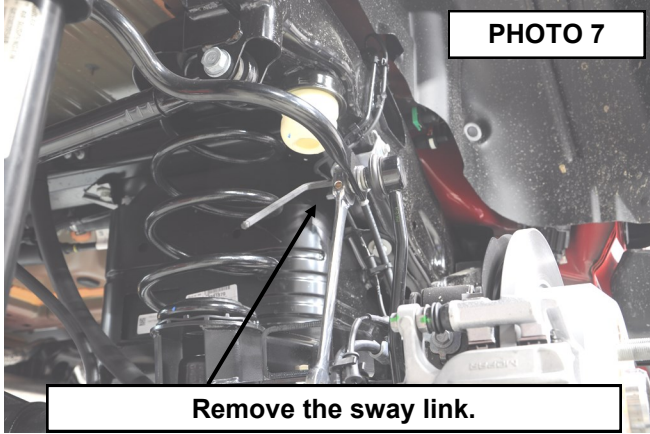

11. Using 18mm wrenches, tighten the upper sway link bolt. Torque to 75ft/lbs. **See Photo 9.**
12. Install the supplied coil spring spacer washer (67730BAG3) on top of the coil spring pocket. **See Photos 10 & 11.**

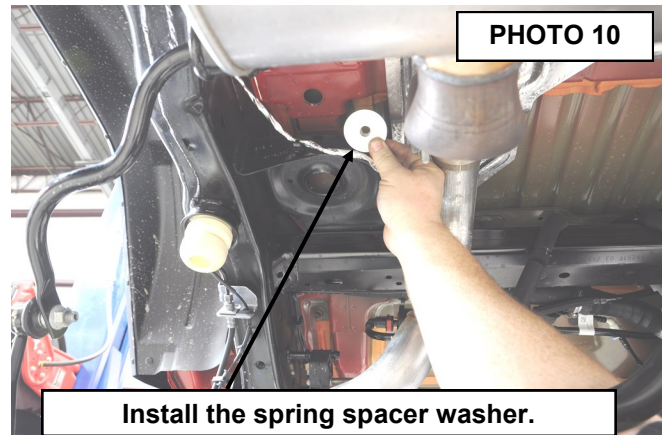
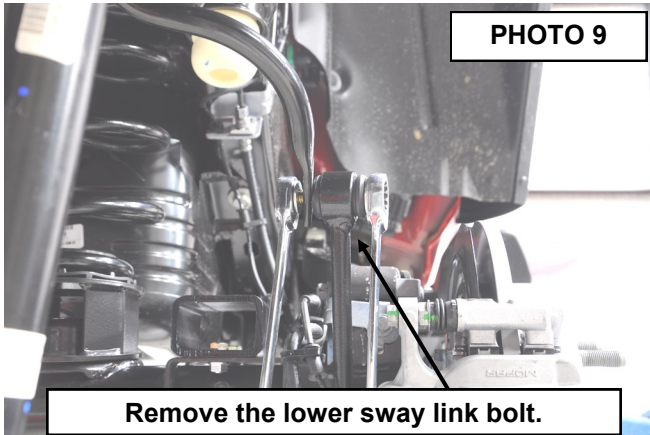

13. Install the supplied rear coil spacer, using the supplied 1/2" x 2.5" bolt (67730BAG3). Tighten using a 3/4" socket.

Torque to 35ft/lbs. **▲ NOTICE** Do Not Over Torque. **See Photo 12.**

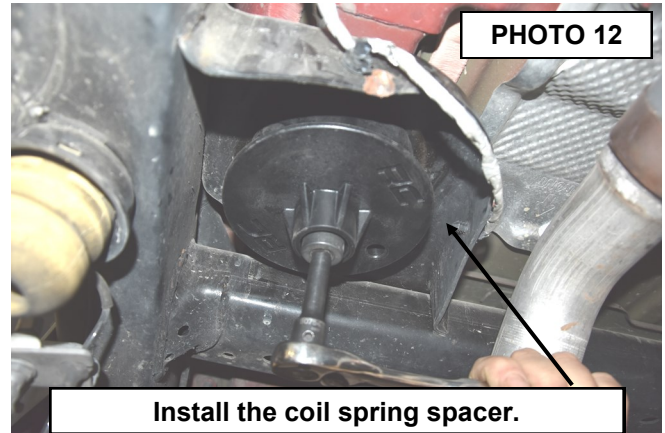
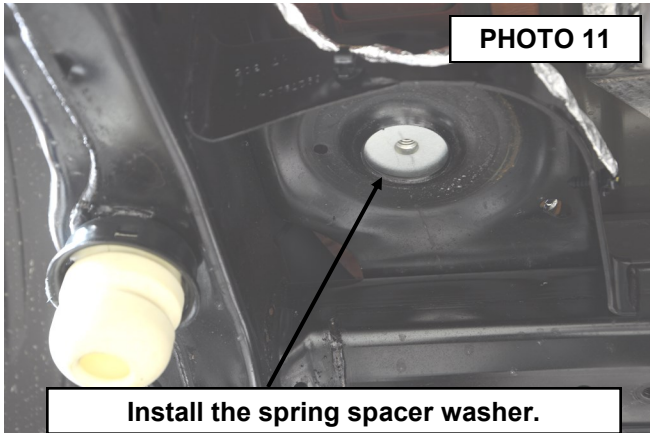

14. Install the coil spring isolator and coil spring. **See Photo 13.**
15. Install the supplied rear shock extension bracket using the factory shock bolt and supplied crush sleeve (1676BAG). Do Not Tighten. **See Photo 14.**

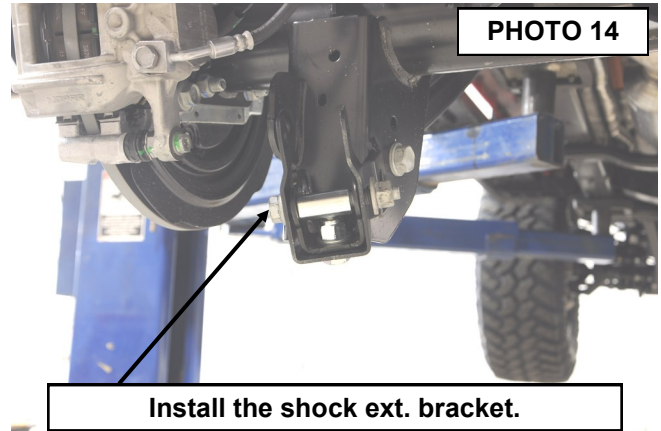
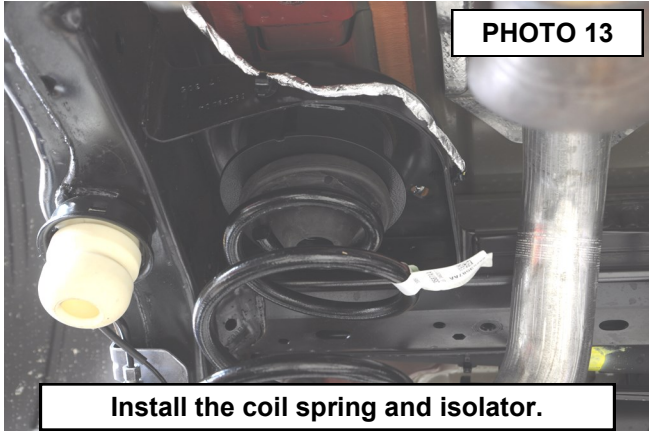

16. Install the supplied 1/2" x 1.25" bolt, washer and 1/2" nylock nut in the bottom shock mounting hole. **The washer will go under the nut.** Do Not Tighten. **See Photo 15.**
17. Install the shock in the shock extension bracket using the supplied 12mm x 65mm bolt, 1/2" washers, and 12mm nut (1676BAG). **See Photo 15.**
18. Tighten the factory shock bolt using an 18mm socket and wrench. Torque to 55ft/lbs. **See Photo 16.**

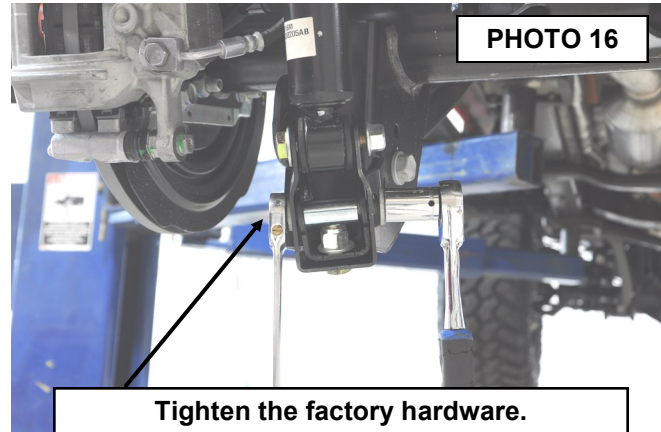
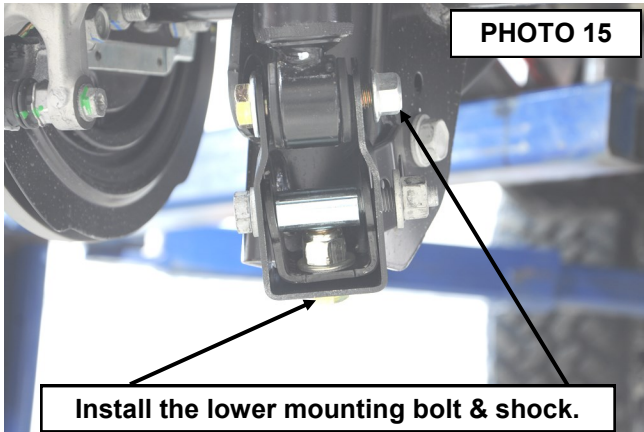

19. Tighten the lower shock bolt using an 18mm socket and wrench. Torque to 55ft/lbs. **See Photo 17.**

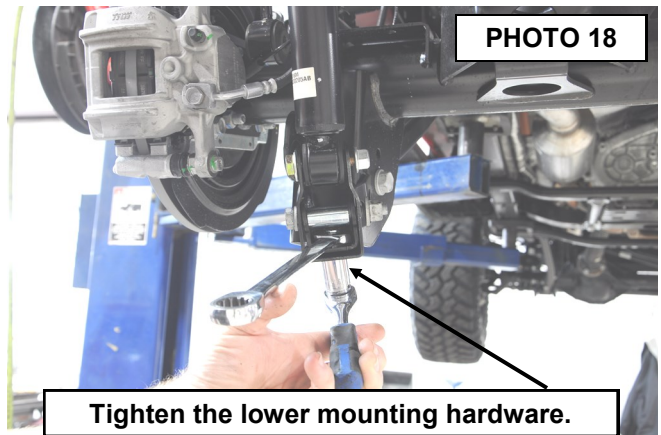
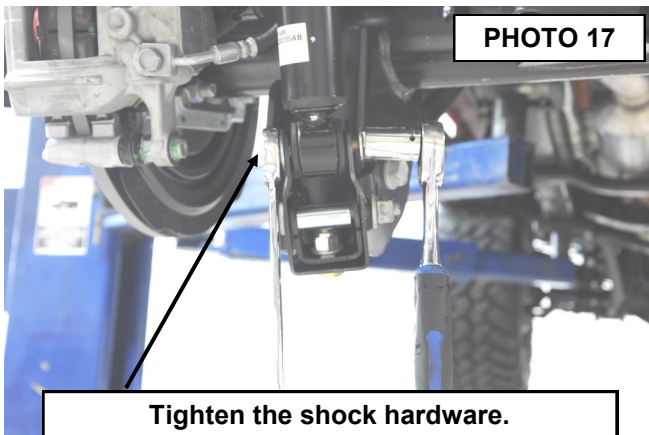

20. Tighten the lower shock bracket bolt using a 3/4" socket and wrench. Torque to 65ft/lbs. **See Photo 18.**
21. Install the sway bar links, in the lower mount using the factory bolts and an 18mm socket and wrench. Torque to 55ft/lbs.
22. Reinstall the rear tires/wheels, using a 22mm deep well socket
23. Lower the vehicle to the ground.
24. Reinstall the track bar in the factory location using the factory hardware and tighten using a 21mm



POST INSTALLATION

1. Confirm that the draglink was adjusted to the center steering wheel **BEFORE** the vehicle is driven. Failure to do so will cause a computer error, odd handling, and poor performance.
2. Check all fasteners for proper torque. Check to ensure there is adequate clearance between all rotating, mobile, fixed and heated members. Check steering for interference and proper working order. Test brake system.
3. Perform steering sweep. The distance between the tire sidewall and the brake hose must be checked closely. Cycle the steering from full turn to full turn to check for clearance. Failure to perform inspections may result in component failure.
4. Re-torque all fasteners after 500 miles and recheck after 1000 miles. Alignment must be checked by a qualified mechanic. Visually inspect components and re-torque fasteners during routine vehicle service.
5. Readjust headlights to proper settings.
6. Have a qualified alignment center realign the front end, to the factory specifications immediately.

MAINTENANCE INFORMATION

It is the ultimate buyers responsibility to have all bolts/nuts checked for tightness after the first 500 miles and then every 1000 miles. Wheel alignment, steering system, suspension and driveline systems must be inspected by a qualified professional mechanic at least every 3000 miles.



Thank you for purchasing a Rough Country Suspension System.

By purchasing any item sold by Rough Country, LLC, the buyer expressly warrants that he/she is in compliance with all applicable , State, and Local laws and regulations regarding the purchase, ownership, and use of the item. It shall be the buyers responsibility to comply with all Federal, State and Local laws governing the sales of any items listed, illustrated or sold. The buyer expressly agrees to indemnify and hold harmless Rough Country, LLC for all claims resulting directly or indirectly from the purchase, ownership, or use of the items.

