

ROUGH COUNTRY

SUSPENSION SYSTEMS®

TOYOTA 2024 Tacoma 3.5" Lift Kits

Thank you for choosing Rough Country for your suspension needs.

Rough Country recommends a certified technician install this system. In addition to these instructions, professional knowledge of disassembly/reassembly procedures as well as post installation checks must be known. Attempts to install this system without this knowledge and expertise may jeopardize the integrity and/or operating safety of the vehicle.

Please read instructions before beginning installation. Check the kit hardware against the parts list on this page and the product layout on the last page. Be sure you have all needed parts and know where they go. Also please review tools needed list and make sure you have needed tools.

PRODUCT USE INFORMATION

▲WARNING As a general rule, the taller a vehicle is, the easier it will roll. Seat belts and shoulder harnesses should be worn at all times. Avoid situations where a side rollover may occur.

Generally, braking performance and capability are decreased when larger/heavier tires and wheels are used. Take this into consideration while driving. Do not add, alter, or fabricate any factory or after-market parts to increase vehicle height over the intended height of the Rough Country product purchased. Mixing component brands is not recommended.

Rough Country makes no claims regarding lifting devices and excludes any and all implied claims. We will not be responsible for any product that is altered.

If questions exist we will be happy to answer any questions concerning the design, function, and correct use of our products.

This suspension system was developed using a Maximum tire size of 265/70R-17 with factory wheels. For aftermarket wheel and tire combinations consult your tire and wheel specialist.

▲NOTICE NOTICE TO DEALER AND VEHICLE OWNER

Any vehicle equipped with any Rough Country product should have a "Warning to Driver" decal installed on the inside of the windshield or on the vehicle's dash. The decal should act as a constant reminder for whoever is operating the vehicle of its unique handling characteristics.

INSTALLING DEALER - it is your responsibility to install the warning decal and forward these installation instructions on to the vehicle owner for review. These instructions should be kept in the vehicle for its service life.

Torque Specs:

Size	Grade 5	Grade 8	Size	Class 8.8	Class 10.9
5/16"	15 ft/lbs	20ft/lbs	6MM	5ft/lbs	9ft/lbs
3/8"	30 ft/lbs	35ft/lbs	8MM	18ft/lbs	23ft/lbs
7/16"	45 ft/lbs	60ft/lbs	10MM	32ft/lbs	45ft/lbs
1/2"	65 ft/lbs	90ft/lbs	12MM	55ft/lbs	75ft/lbs
9/16"	95 ft/lbs	130ft/lbs	14MM	85ft/lbs	120ft/lbs
5/8"	135ft/lbs	175ft/lbs	16MM	130ft/lbs	165ft/lbs
3/4"	185ft/lbs	280ft/lbs	18MM	170ft/lbs	240ft/lbs



KIT CONTENTS:

- 75600991 - 3.5" Kit Box**
- 23328 - N3 Rear Shock Pair**
- 75601 - Upper Control Arms**



PART LIST - 75600991



A



B



C

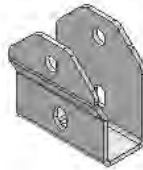

D

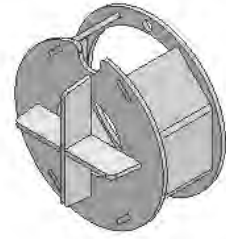

E



F



G



H

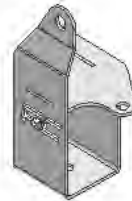

I



J



K



L

TOOLS REQUIRED:

- Strut Compressor
- Hammer
- Pliers
- Jack
- Jack Stands
- 10mm Wrench or Socket
- 12mm Wrench or Socket
- 14mm Wrench or Socket
- 15mm Wrench or Socket
- 16mm Wrench or Socket
- 17mm Wrench or Socket
- 18mm Wrench or Socket
- 19mm Wrench or Socket
- 22mm Wrench or Socket
- 24mm Wrench or Socket
- 36mm Wrench or Socket
- 1/2" Wrench or Socket
- 9/16" Wrench or Socket

Part	QTY	Description
A	2	Strut Spacer Shim
B	2	Front Preload Spacer
C	2	Front Strut Spacer
D	1	Rear Track Bar Bracket
E	2	Rear Spring Spacer
F	1	Rear Track Bar Bracket Shim (Narrow)
G	1	Rear Track Bar Bracket Shim (Wide)
H	2	Rear Sway Bar Bracket
I	1	Dr. Rear Bump Stop Extension
J	1	Pass. Rear Bump Stop Extension
K	2	Rear Brake Line Bracket
L	2	Bump Stop

HARDWARE LIST - 72900BAG1

M



N



O



P



Part	QTY	Description
M	8	10mm Stud
N	8	10mm Serrated Flange Nut
O	1	10mm Hex Nut
P	1	1/2" Jam Nut

HARDWARE LIST - 75600BAG1

Q



R



S



T



U



V



W



X



Y

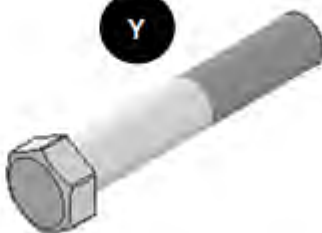

Z



AA



AB



AC



AD



AE



AF



AG



AH



Part	QTY	Description
Q	2	1/2" Flat Washer
R	2	3/8" x 1" Bolt
S	4	3/8" Flat Washer
T	2	5/16" Flat Washer
U	2	3/8" Flange Lock Nut
V	1	10mm x 35mm Bolt
W	1	10mm Flat Washer
X	1	Sleeve
Y	1	14mm x 80mm Bolt
Z	1	14mm Lock Nut

Part	QTY	Description
AA	2	9/16" Flat Washer
AB	2	12mm x 35mm Bolt
AC	2	12mm Flat Washer
AD	2	12mm Flange Lock Nut
AE	2	3/8" Hex Nut
AF	2	3/8" Lock Washer
AG	2	5/16" x 3/4" Bolt
AH	2	5/16" Flange Lock Nut



FRONT INSTALLATION

1. Jack up the front of the vehicle and support the vehicle with jack stands, so that the front wheels are off the ground
2. Remove the front tires/wheels using a 21mm deep well socket.
3. Remove the cotter pin from the tie-rod end with a pair of pliers. Retain hardware for reuse. **See Photo 1.**
4. Loosen, but do not fully remove the castle nut with a 24mm socket. Strike the steering knuckle where the tie-rod end is with a hammer to release the taper. Finish removing the castle nut. Retain hardware for reuse. **See Photo 2.**

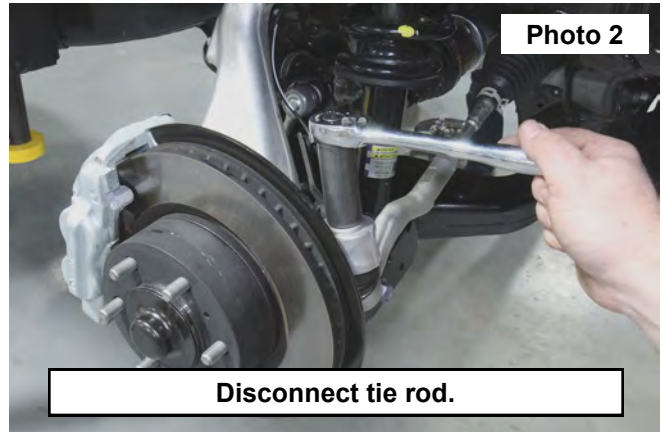
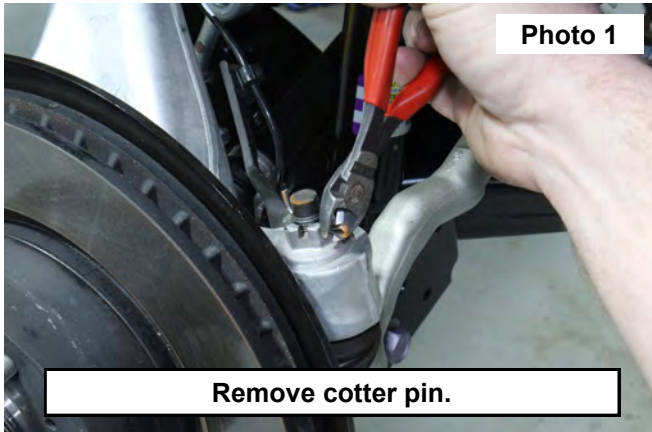

5. Remove the ABS wires from the upper control arm and steering knuckle using a 12mm wrench. Retain hardware for reuse. **See Photo 3 and Photo 4.**

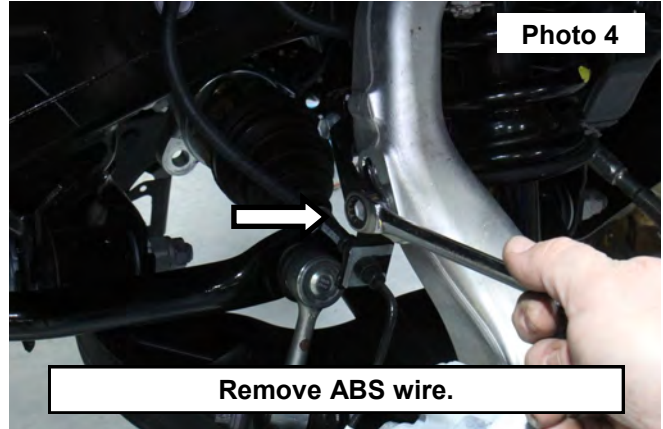
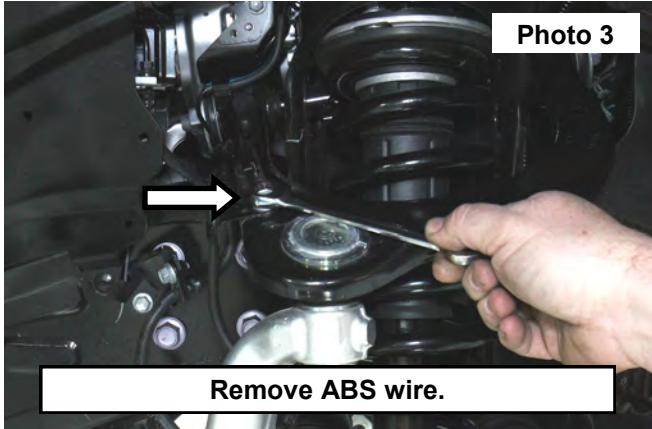

6. Remove ABS sensor from knuckle using a 10mm wrench. Retain hardware for reuse. **See Photo 5.**
7. Use a 19mm socket to remove the bolts holding the brake caliper to the knuckle. Hang brake caliper out of the way. Retain hardware for reuse. **See Photo 6.**

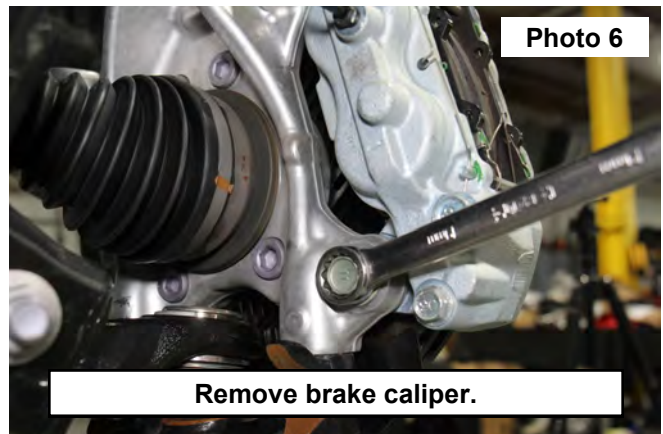
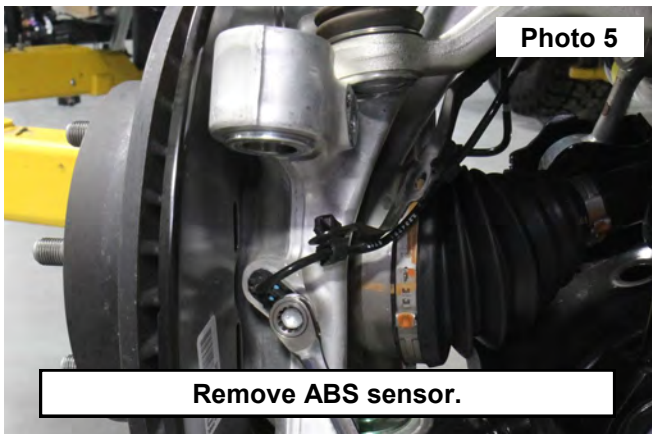

8. Remove the dust cover from the hub bearing with a pry tool and use a 36mm socket to remove the axle nut. Retain hardware for reuse. **See Photo 7.**
9. Remove the cotter pin from the upper ball joint nut and use a 19mm socket to loosen, but not remove the nut. Use a hammer to release the taper of the upper ball joint. Remove the nut. Retain hardware for reuse. **See Photo 8.**

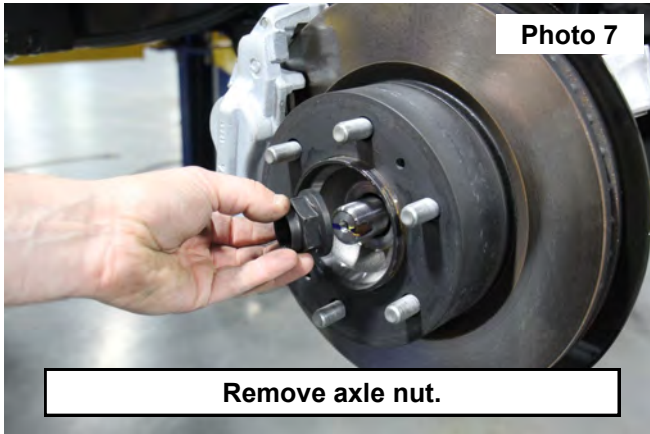

10. Remove lower strut bolt using a 22mm socket. Retain hardware for reuse. **See Photo 9.**
11. Use a 22mm socket to remove the factory bolts holding the lower ball joint housing to the steering knuckle. Retain hardware for reuse. **See Photo 10.**

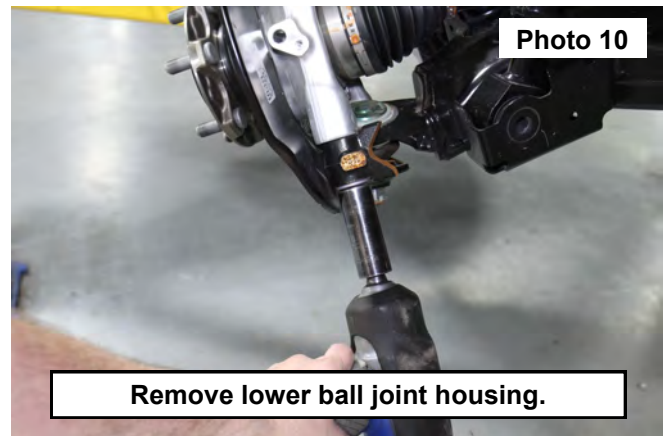
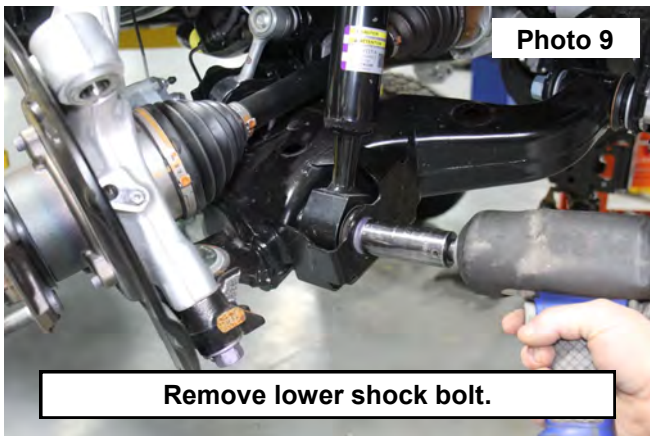

12. Remove sway bar link from the lower control arm with a 19mm socket. Retain hardware for reuse. **See Photo 11.**
13. Loosen, but do not remove, the lower control arm bolts using a 24mm wrench. Swing lower control arm out of the way.
14. Remove upper strut nuts using a 14mm wrench. Retain hardware for reuse. **See Photo 12.**
15. Remove strut from vehicle.
16. Remove factory upper control arms and install upper control arms per instruction sheet **921756010** included with the upper control arm box.

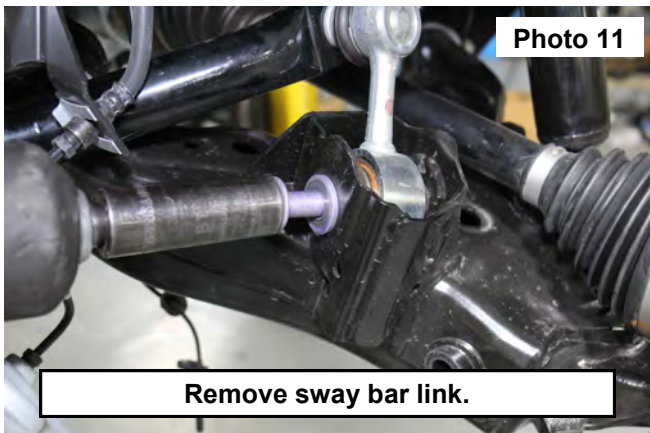

17. Place strut in a strut compressor and mark the placement of the lower spring seat in relation to the shock with a paint pen. Compress the strut and use a 19mm socket to remove the top strut hat. Disassemble strut. **See Photo 13.**
18. Install the front preload spacer (B) onto the strut body with the wider part of the spacer going towards the lower strut mount. **See Photo 14.**
19. Rest the spring seat and spring isolator on the preload spacer. Reassemble the rest of the strut with the strut compressor and 19mm socket. Be sure to keep the previous paint marks aligned.

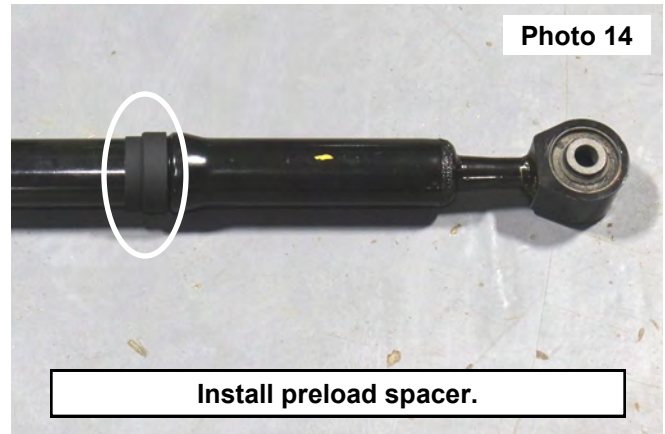
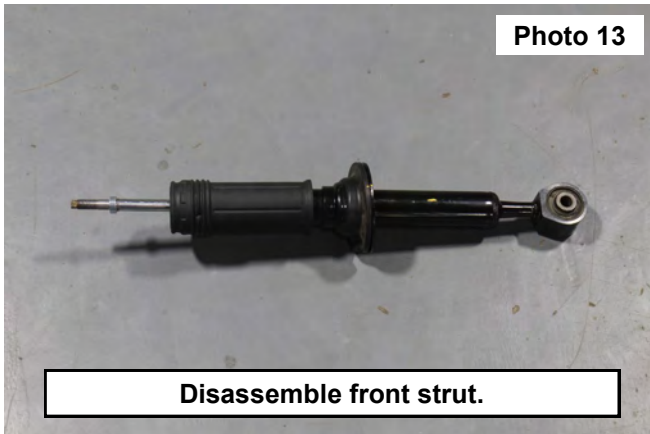

20. Place factory strut nuts back on the studs to protect the threads. Use a grinder or cutting disk to trim the factory strut studs down to where the threads begin. **See Photo 15.**
21. Install the supplied 10mm studs (M) into the strut spacer using the supplied 10mm hex (O) and 1/2" jam nut (P) using a 17mm wrench / socket. **See Photo 16.**

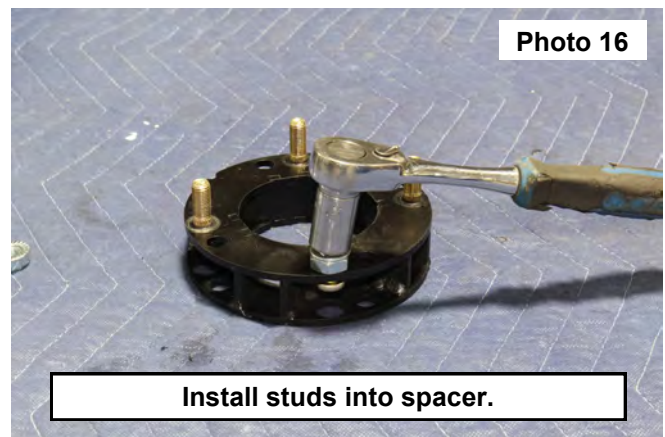
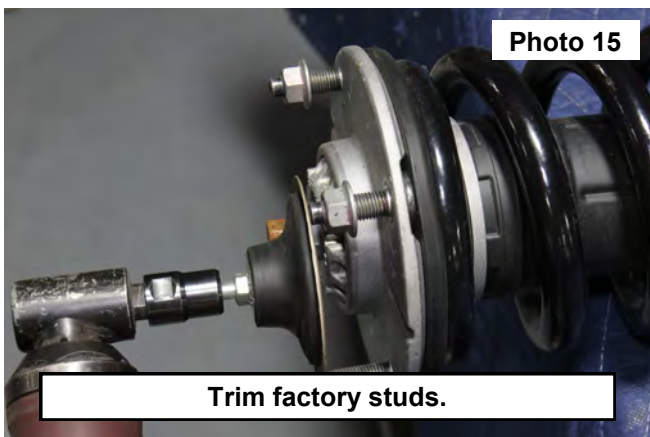

22. Place the strut spacer (C) on top of the strut. Use the factory top strut hardware to secure the spacer to the strut. Tighten with a 14mm wrench. **NOTE:** Be sure the notch in the strut spacer is by the tab of the strut hat. **See Photo 17.**
23. Place strut back into a strut compressor. Compress strut enough so the top hat can spin. Clock the top hat so the stud in the strut spacer is in the same location as the factory stud was. **See Photo 18.**

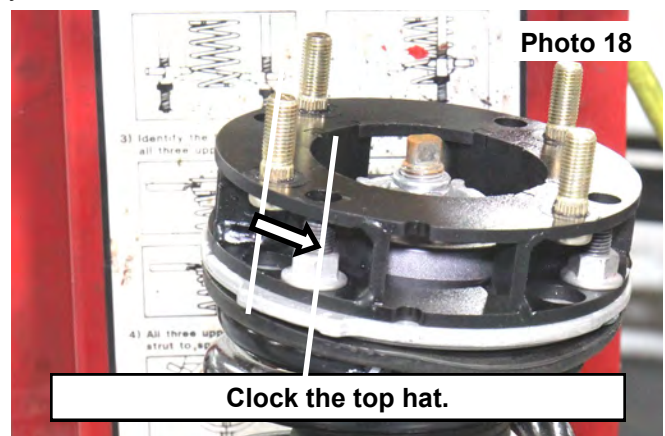
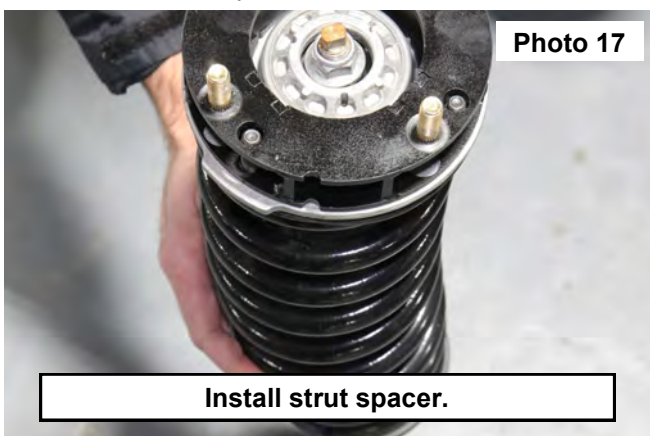

24. Install strut spacer shim **(A)** on top of the strut spacer. **NOTE:** Make sure the notch of the shim aligns with the notch in the strut spacer. **See Photo 19.**
25. Reinstall the strut using the supplied 10mm flange nuts **(N)**. Tighten with a 15mm wrench. Torque to 45ft-lbs. **See Photo 20.**
26. Repeat for other side of vehicle.
27. Reinstall factory lower strut hardware using a 22mm socket and wrench. Torque to 61ft-lbs
28. Reinstall the lower ball joint housing to the knuckle using the factory hardware. Tighten with a 22mm socket. Torque to 118ft-lbs.
29. Reinstall wheels and tires and lower vehicle to the ground. Torque to 83ft-lbs
30. Reinstall lower sway bar link with factory hardware once the vehicle is on the ground. Tighten with a 19mm wrench. Torque to 52ft-lbs.
31. Retighten lower control arm bolts with a 24mm wrench. Torque to 100ft-lbs

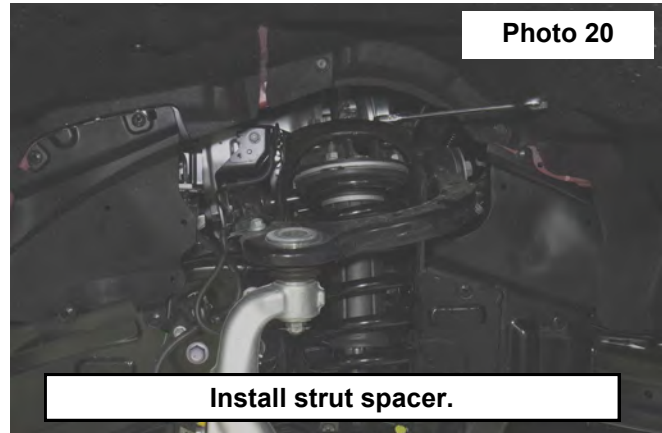
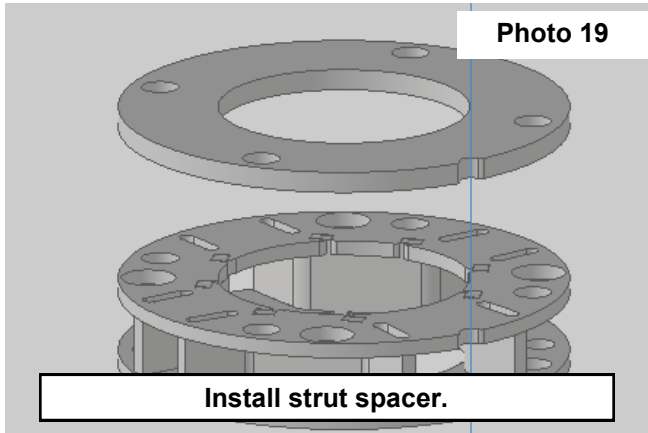

REAR INSTALLATION

1. Jack up the rear of the vehicle and support the vehicle with jack stands, so that the rear wheels are off the ground
2. Remove the rear tires/wheels using a 21mm deep well socket.
3. Remove the rear track bar bolt with a 19mm socket. Retain hardware for reuse. **See Photo 1.**
4. Use a 14mm socket to remove the rear driveshaft hoop. Retain hardware for reuse. **See Photo 2.**

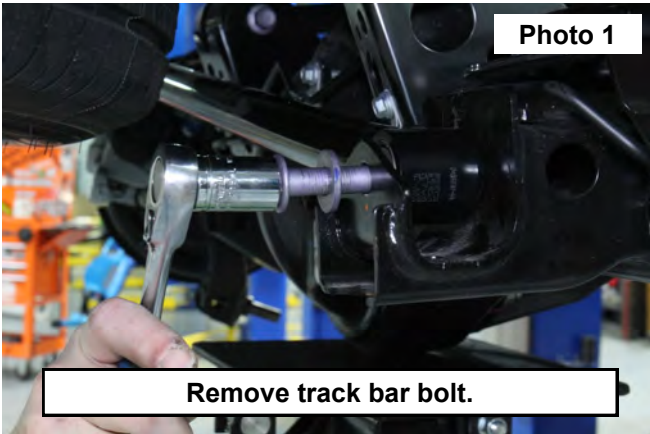

5. Use a pair of pliers to prevent the rear shock from turning. Remove the upper shock nut with a 19mm wrench. **See Photo 3.**
6. Remove the lower shock bolt using a 17mm wrench. **See Photo 4.**

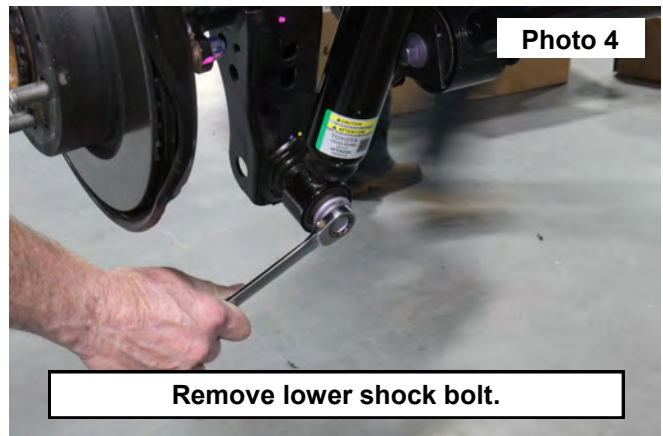
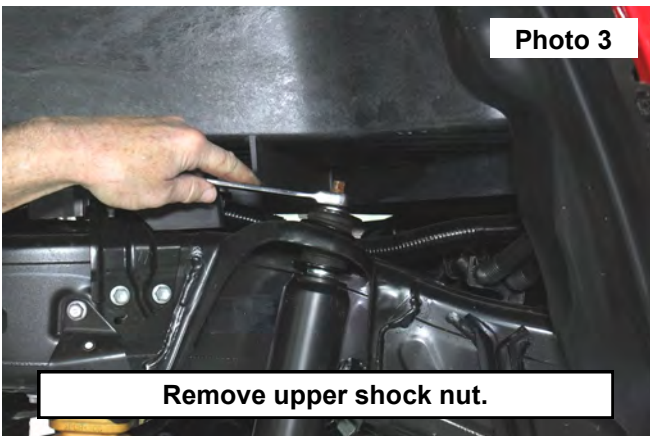

7. Remove rear sway bar link from the frame with a 17mm wrench. Retain hardware for reuse. **See Photo 5.**
8. Remove the ABS wire hardware from the rear axle using a 12mm wrench. Retain hardware for reuse. **See Photo 6.**

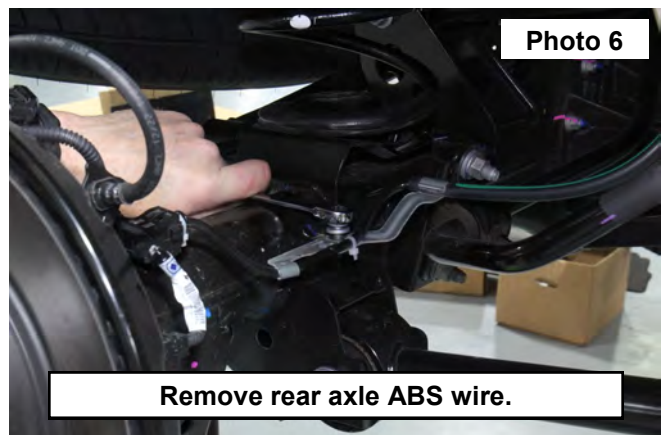

9. Remove the bolt holding the two flexible brake lines to the frame with a 12mm socket. Retain hardware for reuse. **See Photo 7.**
10. Lower the axle and remove the rear coil spring. **See Photo 8.**

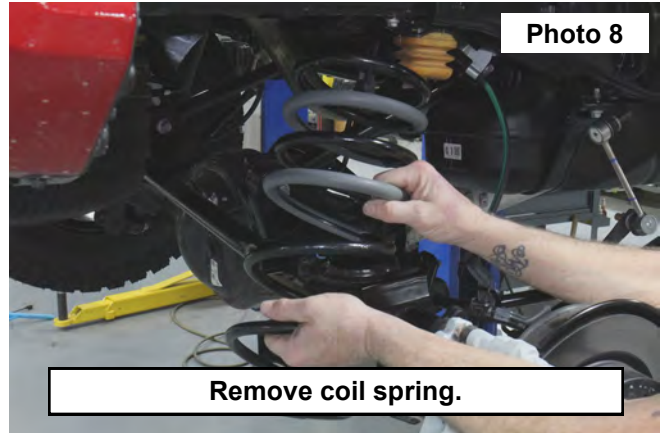
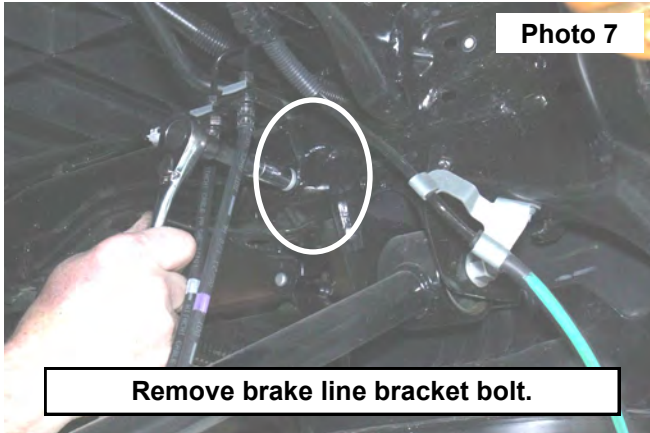

11. Install supplied ABS bracket (**K**) onto the axle using the factory hardware. Tighten with a 12mm wrench. **See Photo 9.**
12. Connect the ABS wire mount to the previously installed ABS bracket using the supplied 5/16" x 3/4" bolt (**AG**), 5/16" flat washer (**T**), and 5/16" flange lock nut (**AH**). Tighten with a 1/2" wrench and socket. Repeat for other side. **See Photo 10.**

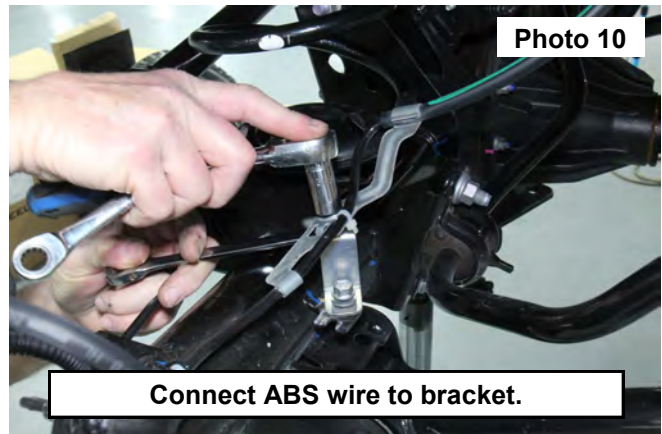
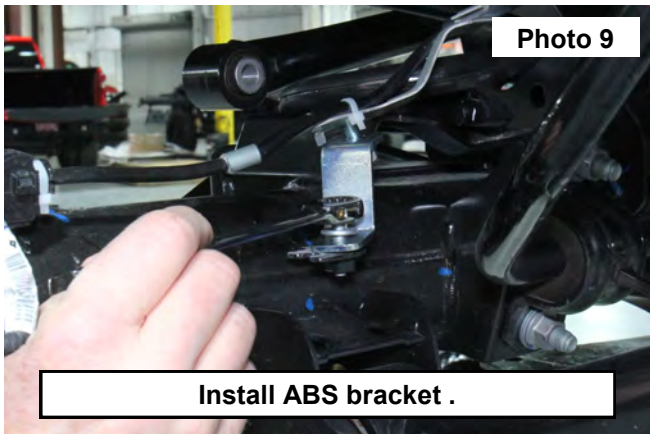

13. Install the supplied 3/8" x 1" bolt (**R**) and 3/8" washer (**S**) into the small hole in the frame where the coil spring was. Align the rear coil spring spacer with the bolt that was previously installed and secure the spacer with the supplied 3/8" flanged lock nut (**U**). Tighten with a 9/16" wrench and socket. **See Photo 11.**
14. Reinstall factory coil spring.
15. Install the supplied rear shocks using the hardware supplied in the shock box. Use an 18mm wrench to tighten the upper shock bolt and a 17mm wrench to tighten the lower shock bolt. **See Photo 12.**

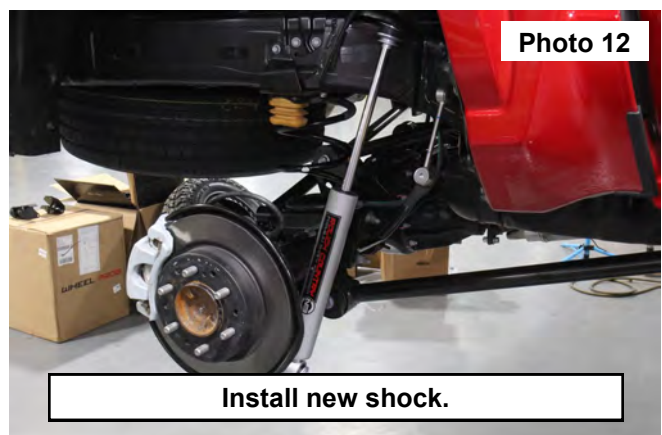
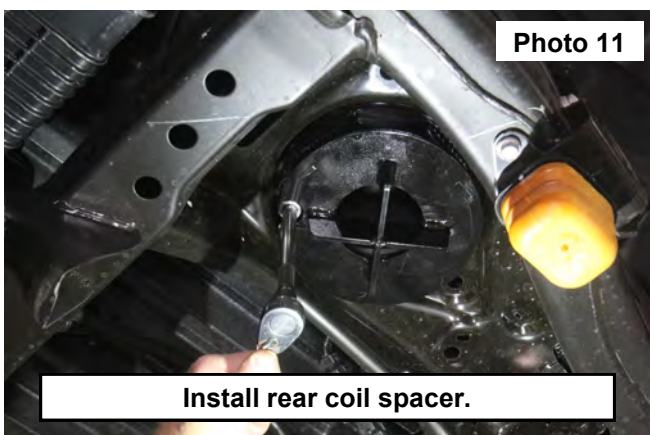

16. Remove the three factory bolts holding the rear bump stop with a 12mm wrench. Retain hardware for reuse. **See Photo 13.**
17. Install the supplied bump stops (**L**) to the RC bump stop bracket (**I and J**) with the supplied 3/8" flat washer (**S**), lock washer (**AF**), and nut (**AE**). Tighten with a 9/16" wrench. Install new rear bump stop with factory hardware. Tighten with a 12mm wrench. **See Photo 14.**

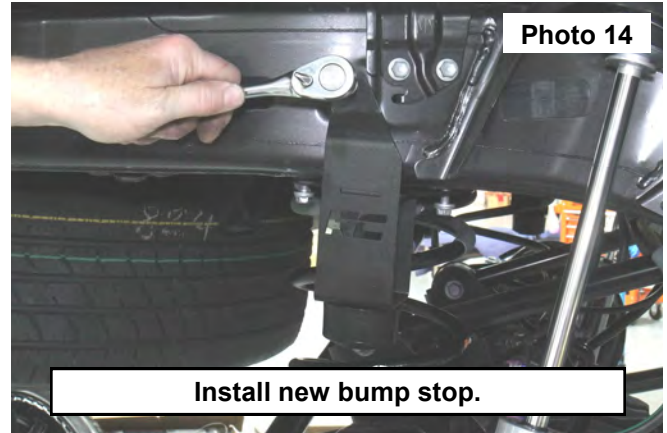
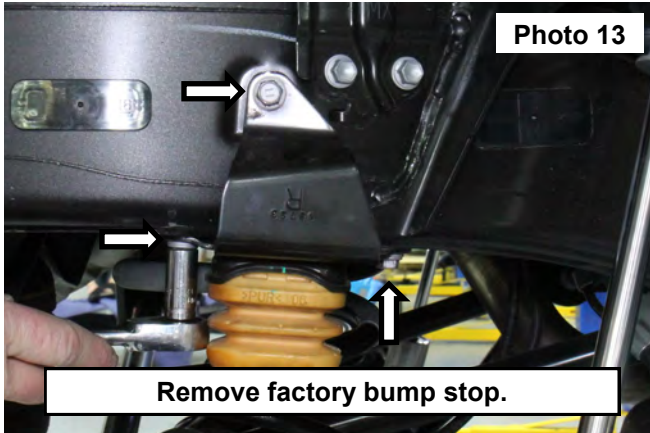

18. Remove lower sway bar link from the rear sway bar using a 17mm socket. Retain hardware for reuse. **See Photo 15.**
19. Install sway bar extension (**H**) using the supplied 12mm bolt (**AB**), washer (**AC**), and lock nut (**AD**). Tighten with an 18mm and 19mm wrench. **See Photo 16.**

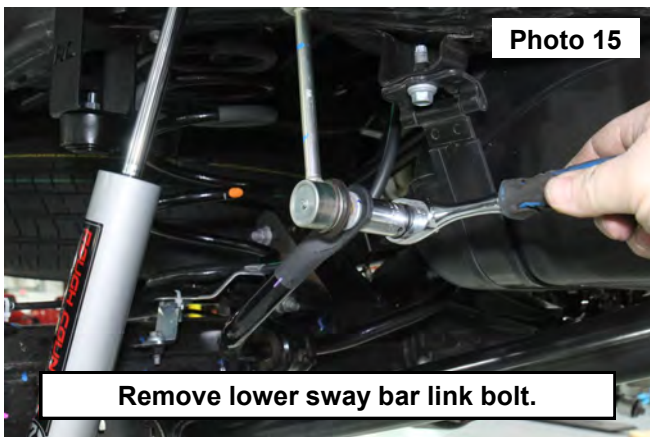

20. Reconnect sway bar link to the frame using the factory hardware. Tighten with a 17mm wrench.
21. Place the two track bar shims in the factory track bar mount. The narrow shim (**F**) will be placed underneath the wider shim (**G**). **See Photo 17.**
22. Place track bar relocation bracket (**D**) on top of the two shims. Slide supplied 10mm flange nut (**N**) underneath the bracket. Place supplied 10mm flat washer (**W**) on top of the relocation bracket. Slide the supplied 10mm x 35mm bolt (**V**) through the relocation bracket and two shims and tighten the hardware with a 16mm wrench and socket. **See Photo 18.**

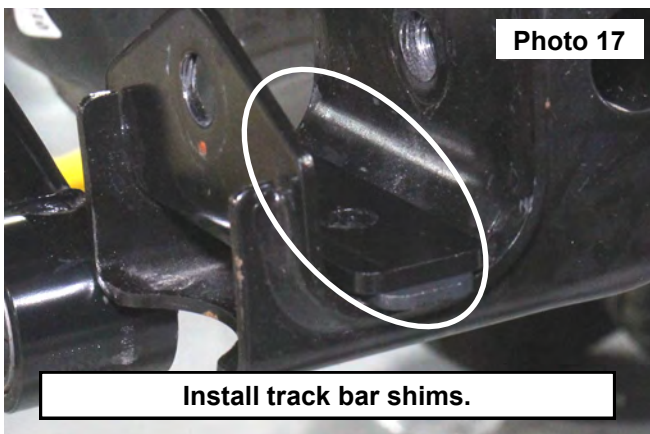

23. Install supplied sleeve (X) with the factory track bar bolt in the factory bolt location. Tighten with a 19mm socket. **See Photo 19.**
24. Install the rear track bar into the relocation bracket using the supplied 14mm x 80mm bolt (Y), (2) 9/16" Flat washer (AA) and 14mm lock nut (Z). Tighten with a 22mm wrench. **See Photo 20.**
25. Reinstall the factory bolt holding the two flexible brake lines to the frame with a 12mm socket.
26. Reinstall wheels and lower vehicle to the ground.



POST INSTALLATION

1. Check and recheck all fasteners for proper torque. Check to ensure there is adequate clearance between all rotating, mobile, fixed and heated members. Check clearance between upper control arm and sidewall of tire for proper clearance. Check steering for interference and proper working order. Test brake system.
2. Perform steering sweep. Cycle the steering from full turn to full turn to check for clearance. Failure to perform inspections may result in component failure.
3. Have vehicle aligned to factory specifications.
4. Re torque all fasteners after 500 miles. Visually inspect components and re torque fasteners during routine vehicle service.
5. Adjust headlights to proper settings given increased vehicle height.

MAINTENANCE INFORMATION

It is the ultimate buyers responsibility to have all bolts/nuts checked for tightness after the first 500 miles and then every 1000 miles. Wheel alignment steering system, suspension and driveline systems must be inspected by a qualified professional mechanic at least every 3000 miles.



By purchasing any item sold by Rough Country, LLC, the buyer expressly warrants that he/she is in compliance with all applicable , State, and Local laws and regulations regarding the purchase, ownership, and use of the item. It shall be the buyers responsibility to comply with all Federal, State and Local laws governing the sales of any items listed, illustrated or sold. The buyer expressly agrees to indemnify and hold harmless Rough Country, LLC for all claims resulting directly or indirectly from the purchase, ownership, or use of the items.

