



TOYOTA 2022 Tundra 4” and 6” Knuckle Kit

Thank you for choosing Rough Country for all your suspension needs.

Rough Country recommends a certified technician install this system. In addition to these instructions, professional knowledge of disassemble/reassembly procedures as well as post installation checks must be known. Attempts to install this system without this knowledge and expertise may jeopardize the integrity and/or operating safety of the vehicle.

Please read instructions before beginning installation. Check the kit hardware against the parts list. Be sure you have all needed parts and know where they go. Also please review the tool list and make sure you have the necessary tools to install the kit.

⚠️ WARNING

As a general rule, the taller a vehicle is, the easier it will roll. We strongly recommend, because of rollover possibility, that seat belts and shoulder harnesses should be worn at all times. Avoid situations where a side rollover may occur. Generally, braking performance and capability are decreased when larger/heavier tires and wheels are used. Take this into consideration while driving. Do not add, alter, or fabricate any factory or after-market parts to increase vehicle height over the intended height of the Rough Country product purchased. Mixing component brands is not recommended.

Rough Country makes no claims regarding lifting devices and excludes any and all implied claims. We will not be responsible for any product that is altered. We will be happy to answer any questions concerning the design, function, and correct use of our products.

This suspension system was developed to accommodate a **Maximum tire size of 35 x 12.50 on an 20x9” +20mm Off-set.** Larger tires or different wheel offsets will need to be verified prior to use.

⚠️ NOTICE

NOTICE TO DEALER AND VEHICLE OWNER

Any vehicle equipped with any Rough Country product should have a “Warning to Driver” decal installed on the inside of the windshield or on the vehicle’s dash. The decal should act as a constant reminder for whoever is operating the vehicle of its unique handling characteristics. It is your responsibility to install the warning decal and forward these installation instructions on to the vehicle owner for review. These instructions should be kept in the vehicle for its service life.

⚠️ NOTICE

Note to installer : Before installation begins we recommend that a test drive be performed. While driving check for uncommon sounds and/or vibrations . What you feel and hear during the test drive will only magnify once lift kit is installed. Advise you to discuss possible issues identified from drive with customer before proceeding to install this kit.

Torque Specs:

Size	Grade 5	Grade 8	Size	Class 8.8	Class 10.9
5/16”	15 ft/lbs	20ft/lbs	6MM	5ft/lbs	9ft/lbs
3/8”	30 ft/lbs	35ft/lbs	8MM	18ft/lbs	23ft/lbs
7/16”	45 ft/lbs	60ft/lbs	10MM	32ft/lbs	45ft/lbs
1/2”	65 ft/lbs	90ft/lbs	12MM	55ft/lbs	75ft/lbs
9/16”	95 ft/lbs	130ft/lbs	14MM	85ft/lbs	120ft/lbs
5/8”	135ft/lbs	175ft/lbs	16MM	130ft/lbs	165ft/lbs
3/4”	185ft/lbs	280ft/lbs	18MM	170ft/lbs	240ft/lbs



71230

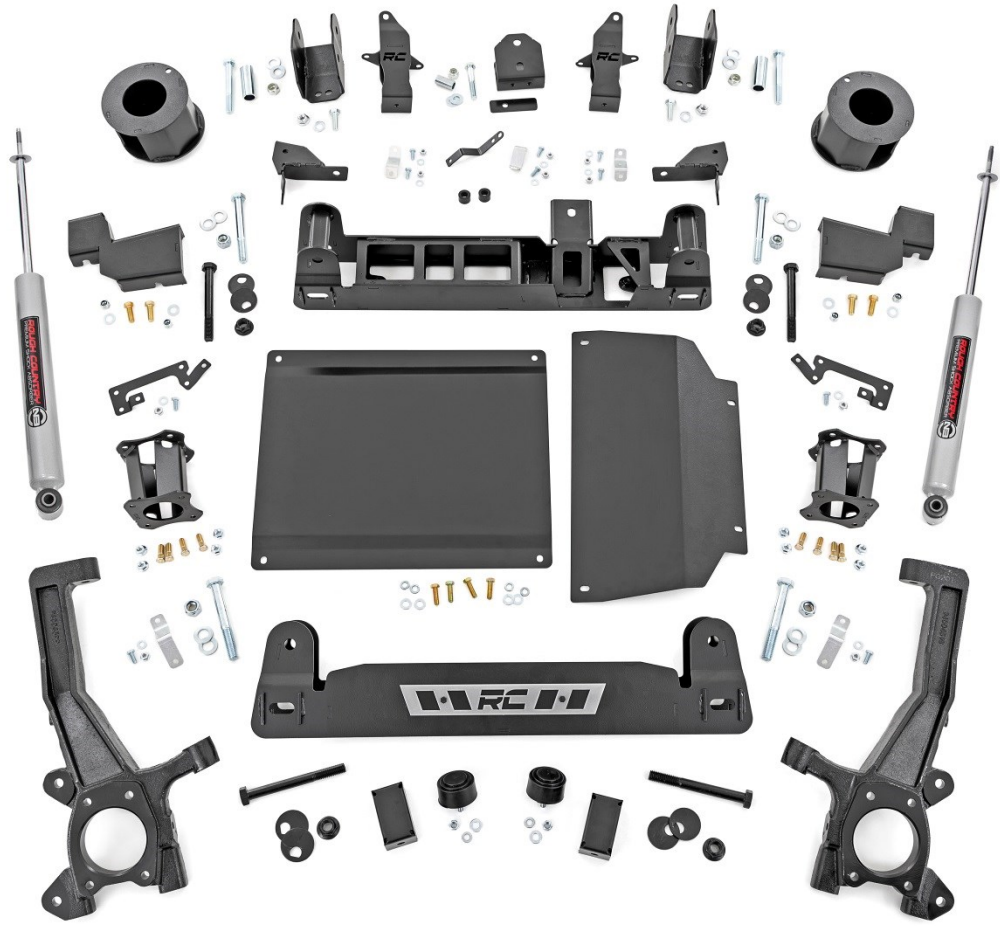

71231

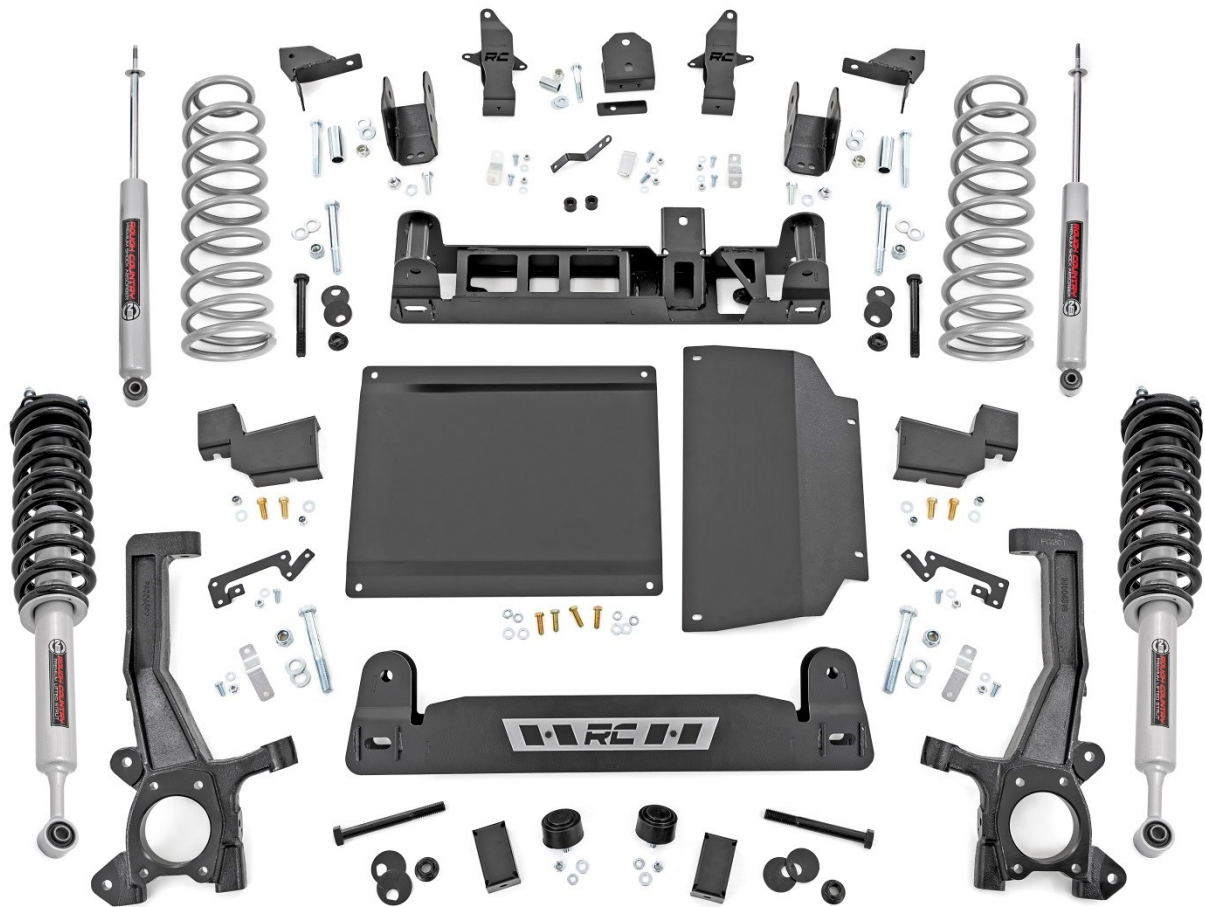

4" Kit Contents

71230991

Driver Knuckle x1
Passenger Knuckle x1

70430992 (70430)

4" Kit Box

71230BAG1 x1
71230BAG2 x1
71230BAG3 x1
Bump Stop x2
Bump Stop Extension x2
RC Crossmember Badge x1
Front Brake Bracket x1
Axle Brake Line Bracket x3
Rear Track Bar Bracket x1
Rear Track Bar Bracket Shim x1
FRT Driver Sway Bar Drop x1
FRT Pass Sway Drop x1
Driver Upper Brake Line Bracket x1
Pass Upper Brake Line Bracket x1
FNT Lower Brake Line Brackets x2
Rear Coil Spacers x2
Rear Driver Sway Bar Drop x1
Rear Pass Sway Bar Drop x1
Rear Driver Bump Stop x1
Rear Pass Bump Stop x1
Rear Shock Extension x2
Tundra 6" Instruction sheet x1
Knuckle Shims x2

70431992 (70431)

4" Kit Box

71230BAG1 x1
71230BAG2 x1
71230BAG3 x1
Bump Stop x2
Bump Stop Extension x2
RC Crossmember Badge x1
Front Brake Bracket x1
Axle Brake Line Bracket x3
Rear Track Bar Bracket x1
Rear Track Bar Bracket Shim x1
FRT Driver Sway Bar Drop x1
FRT Pass Sway Drop x1
Driver Upper Brake Line Bracket x1
Pass Upper Brake Line Bracket x1
FNT Lower Brake Line Brackets x2
Rear Driver Sway Bar Drop x1
Rear Pass Sway Bar Drop x1
Rear Driver Bump Stop x1
Rear Pass Bump Stop x1
Rear Shock Extension x2
Tundra 6" Instruction sheet x1
Knuckle Shims x2

71230993

Tundra Rear Crossmember x1
Tundra Front Crossmember x1

71230994

Tundra 6" Upper Strut Spacers x2
10mm Stud Bag x2

71230995

Tundra Front Skid Plate x1
Tundra Skid Plate x1

23329 - N3 Shock Pair

9456 (71231) - Coil Springs

501150 (71231) - N3 Loaded Strut

71230BAG1

Cam Bolt x2
Flange Lock Nuts x2
18MM Cam Bolt Set x4
Cam Washer x2

71230BAG2

7/16-14 X 1.25 Hex Bolt x4
7/16 Flat Washer x4
7/16-14 Nylock Nut x4
18mm Flat Washer x8
18mm-2.5mm Nylock Nut x4
18mm-2.5mm x 140mm Hex Bolt x2
18mm-2.5mm x 150mm Hex Bolt x2
6mm-1.0 Nylock Nut x2
6mm-1.0 x 20mm Hex Head Bolt x2
3/8-16 x 1.25 Hex Bolt x4
3/8 Flat Washer x6
3/8 Lock Washer x6
3/8-16 Hex Nut x2
10mm-1.25 x 35mm Hex Bolt x5
10mm Lock Washer x2
10mm Flat Washer x5
10mm-1.25 Serrated Nut x5

71230BAG3

5/16-18x 3/4 Hex Head Bolt x10
5/16 Flat Washer x10
5/16 Flange Lock Nut x10
Upper Arm Spacer x2
Control Arm Sleeve x2
14mm-2.0 x 110mm Hex Head Bolt x2
14mm-2.0 Nylock Nuts x3
5/8 Flat Washer x6
12mm-1.75 Flange Lock x2
12mm-1.75 x 35mm Hex Head Bolt x2
12mm Flat Washer x2

Tools Needed:

10mm Socket/Wrench
12mm Socket/Wrench
13mm Socket/Wrench
14mm Socket/Wrench
15mm Socket/Wrench
17mm Socket/Wrench
19mm Socket/Wrench
22mm Socket/Wrench
24mm Socket/Wrench
43mm Socket/Wrench
1/2" Socket/Wrench
9/16" Socket/Wrench
5/8" Socket/Wrench
3/4" Socket/Wrench
1-1/8" Socket/Wrench
Trim Remover Tool



6" Kit Contents

71230991

Driver Knuckle x1
Passenger Knuckle x1

71230992 (71230)

6" Kit Box

71230BAG1 x1
71230BAG2 x1
71230BAG3 x1
Bump Stop x2
Bump Stop Extension x2
RC Crossmember Badge x1
Front Brake Bracket x1
Axle Brake Line Bracket x3
Rear Track Bar Bracket x1
Rear Track Bar Bracket Shim x1
FRT Driver Sway Bar Drop x1
FRT Pass Sway Drop x1
Driver Upper Brake Line Bracket x1
Pass Upper Brake Line Bracket x1
FNT Lower Brake Line Brackets x2
Rear Coil Spacers x2
Rear Driver Sway Bar Drop x1
Rear Pass Sway Bar Drop x1
Rear Upper Control Arm Bracket x2
Rear Driver Bump Stop x1
Rear Pass Bump Stop x1
Rear Shock Extension x2
Tundra 6" Instruction sheet x1
Knuckle Shims x2

71231992 (71231)

6" Kit Box

71230BAG1 x1
71230BAG2 x1
71230BAG3 x1
Bump Stop x2
Bump Stop Extension x2
RC Crossmember Badge x1
Front Brake Bracket x1
Axle Brake Line Bracket x3
Rear Track Bar Bracket x1
Rear Track Bar Bracket Shim x1
FRT Driver Sway Bar Drop x1
FRT Pass Sway Drop x1
Driver Upper Brake Line Bracket x1
Pass Upper Brake Line Bracket x1
FNT Lower Brake Line Brackets x2
Rear Driver Sway Bar Drop x1
Rear Pass Sway Bar Drop x1
Rear Upper Control Arm Bracket x2
Rear Driver Bump Stop x1
Rear Pass Bump Stop x1
Rear Shock Extension x2
Tundra 6" Instruction sheet x1
Knuckle Shims x2

71230993

Tundra Rear Crossmember x1
Tundra Front Crossmember x1

71230994

Tundra 6" Upper Strut Spacers x2
10mm Stud Bag x2

71230995

Tundra Front Skid Plate x1
Tundra Skid Plate x1

23329 - N3 Shock Pair

9456 (71231) - Coil Springs

501150 (71231) - N3 Loaded Strut

71230BAG1

Cam Bolt x2
Flange Lock Nuts x2
18MM Cam Bolt Set x4
Cam Washer x2

71230BAG2

7/16-14 X 1.25 Hex Bolt x4
7/16 Flat Washer x4
7/16-14 Nylock Nut x4
18mm Flat Washer x8
18mm-2.5mm Nylock Nut x4
18mm-2.5mm x 140mm Hex Bolt x2
18mm-2.5mm x 150mm Hex Bolt x2
6mm-1.0 Nylock Nut x2
6mm-1.0 x 20mm Hex Head Bolt x2
3/8-16 x 1.25 Hex Bolt x4
3/8 Flat Washer x6
3/8 Lock Washer x6
3/8-16 Hex Nut x2
10mm-1.25 x 35mm Hex Bolt x5
10mm Lock Washer x2
10mm Flat Washer x5
10mm-1.25 Serrated Nut x5

71230BAG3

5/16-18x 3/4 Hex Head Bolt x10
5/16 Flat Washer x10
5/16 Flange Lock Nut x10
Upper Arm Spacer x2
Control Arm Sleeve x2
14mm-2.0 x 110mm Hex Head Bolt x2
14mm-2.0 Nylock Nuts x3
5/8 Flat Washer x6
12mm-1.75 Flange Lock x2
12mm-1.75 x 35mm Hex Head Bolt x2
12mm Flat Washer x2

Tools Needed:

10mm Socket/Wrench
12mm Socket/Wrench
13mm Socket/Wrench
14mm Socket/Wrench
15mm Socket/Wrench
17mm Socket/Wrench
19mm Socket/Wrench
22mm Socket/Wrench
24mm Socket/Wrench
43mm Socket/Wrench
1/2" Socket/Wrench
9/16" Socket/Wrench
5/8" Socket/Wrench
3/4" Socket/Wrench
1-1/8" Socket/Wrench
Trim Remover Tool



FRONT INSTALLATION INSTRUCTIONS

1. Jack up the front of the vehicle and place on jack stands. Remove the front wheels.
2. Remove 2 bolts from the center of the air dam using a 10mm socket/wrench to release the air dam. **See Photo 1.**
3. Remove the 4 bolts from the skid plate using a 12mm socket/wrench. **See Photo 2.**

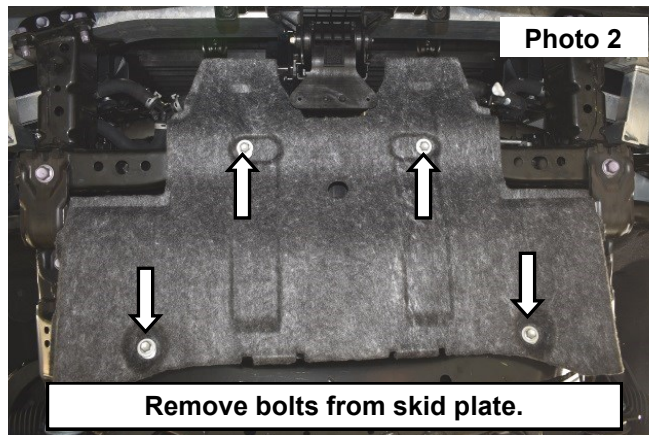
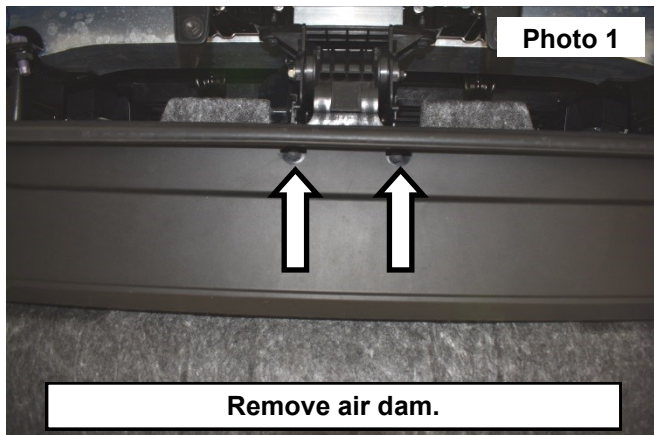

4. Unplug the rack and pinion. **See Photo 3.**
5. Remove the sway bar from the frame using a 17mm socket/wrench. **See Photo 4.**

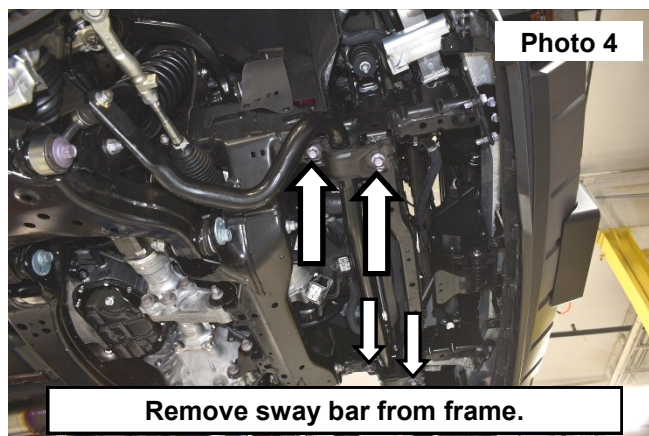
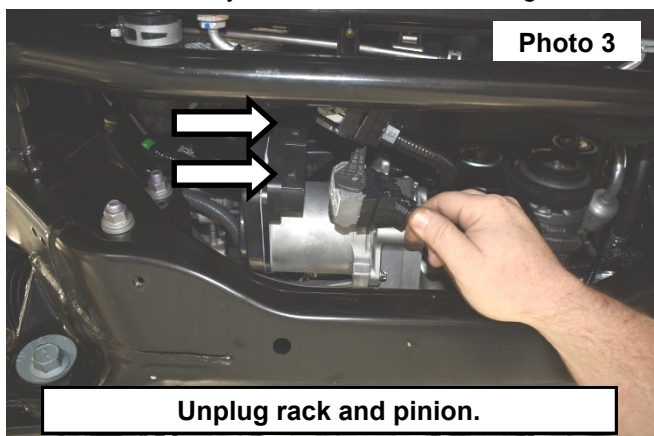

6. Remove the sway bar from the control arms using a 19mm socket/wrench. **See Photo 5.**
7. Remove the tie rod end from the knuckle using a 24mm socket/wrench. **See Photo 6.**

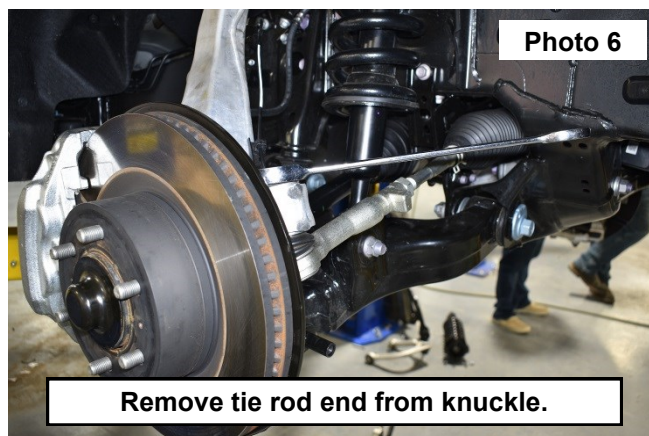
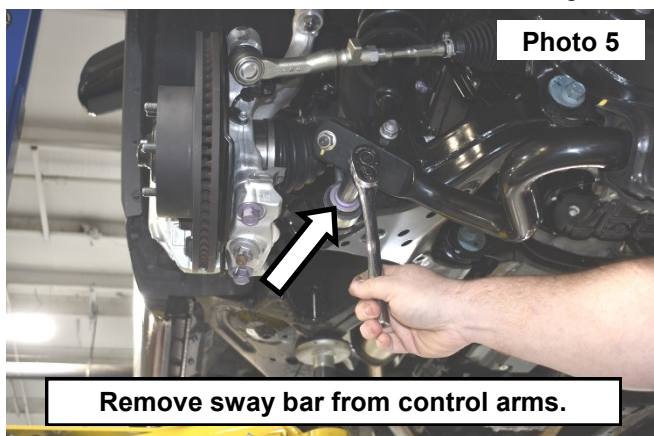

8. Remove the J-clip from the upper ball joint nut and remove the nut using a 19mm socket/wrench. **See Photo 7.**
9. Remove the ABS wire from the lower knuckle using a 10mm socket/wrench. **See Photo 8.**

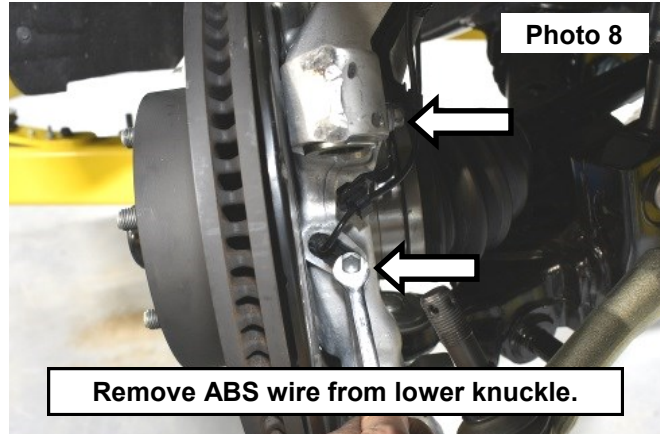

10. Remove the ABS wire and brake line bracket from the knuckle using a 10mm & 12mm socket/wrench. **See Photo 9.**
11. Remove the ABS wire from the upper control arm using a 10mm socket/wrench. **See Photo 10.**

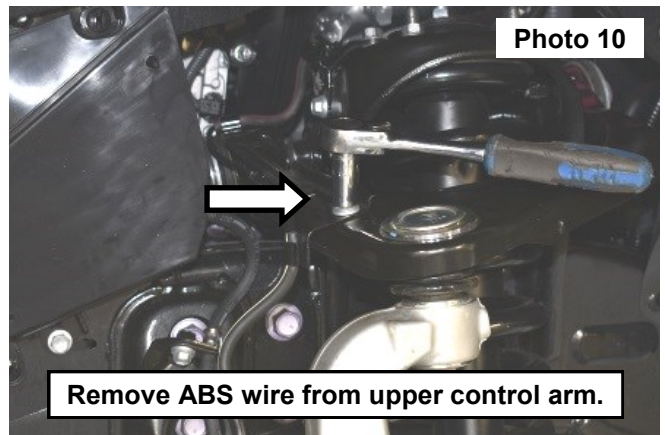
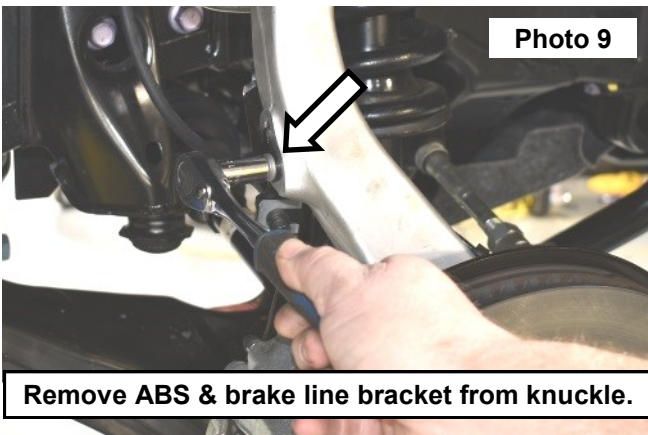

12. Remove the brake line bracket from the frame using a 12mm socket/wrench. **See Photo 11.**
 13. Remove the brake caliper from the knuckle using a 19mm socket/wrench. **See Photo 12.**
- NOTE: After removing caliper, hang it using hooks or rest on a stand--do NOT hang it from the brake line.**

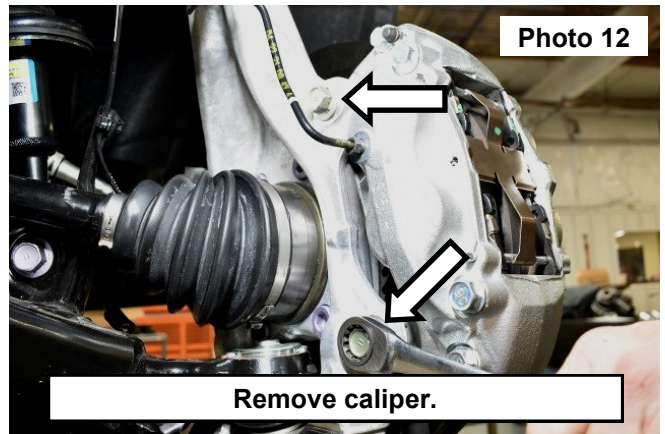
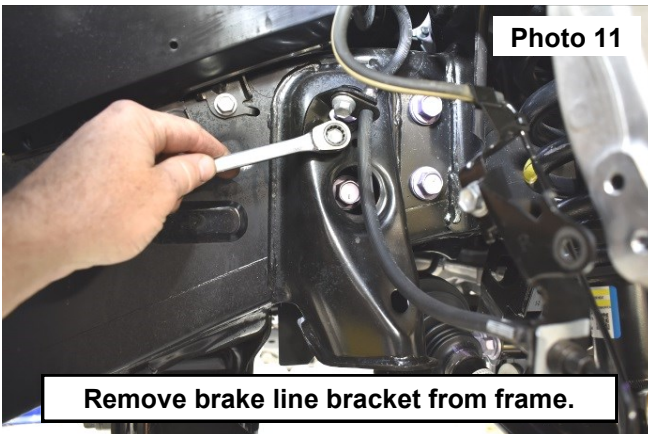

14. Remove the rotor, axle nut cup, and the cotter pin from the locking ring. See Photo 13 and Photo 14.

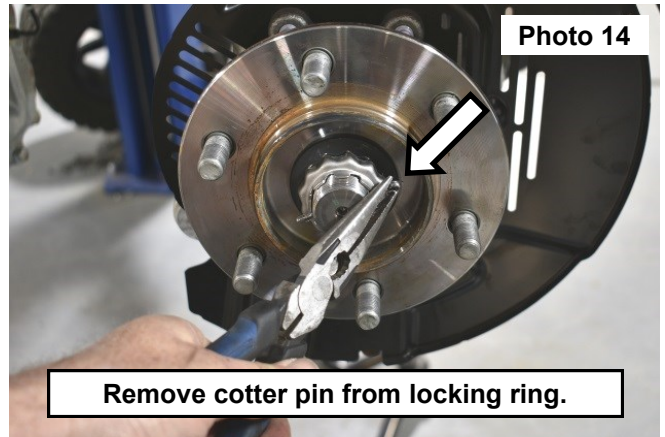
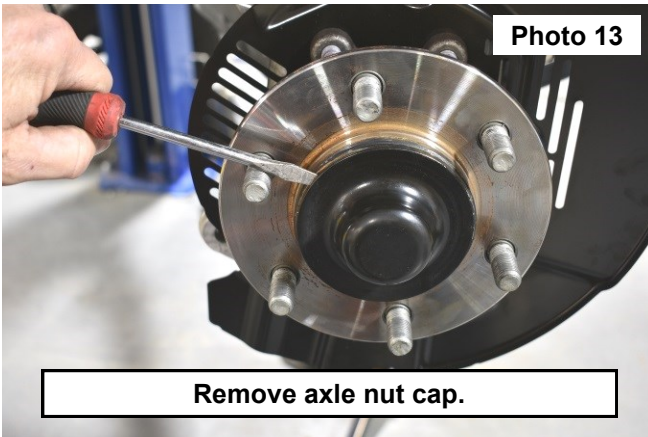

15. Remove the locking ring and remove the cotter pin using a 43mm socket. See Photo 15 and Photo 16.

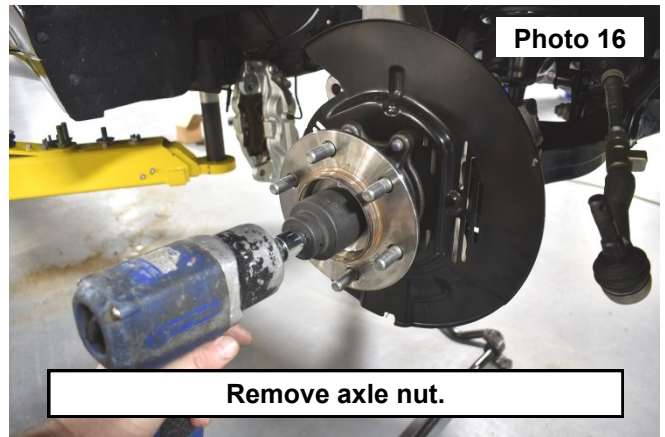
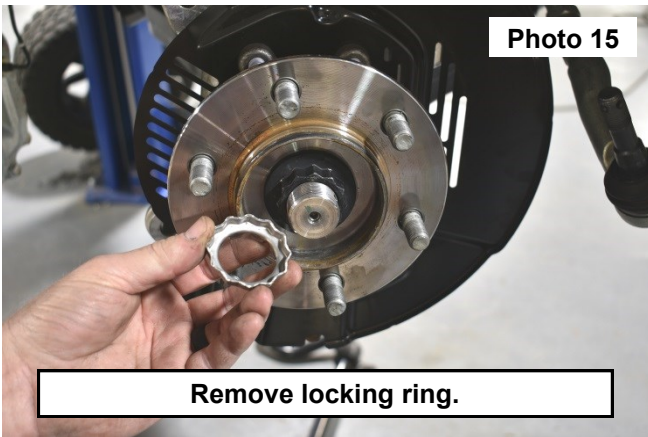

16. Remove the bolts for the knuckle from the lower control arm using a 22mm socket/wrench. See Photo 17.

17. Remove the knuckle from the axle. See Photo 18.

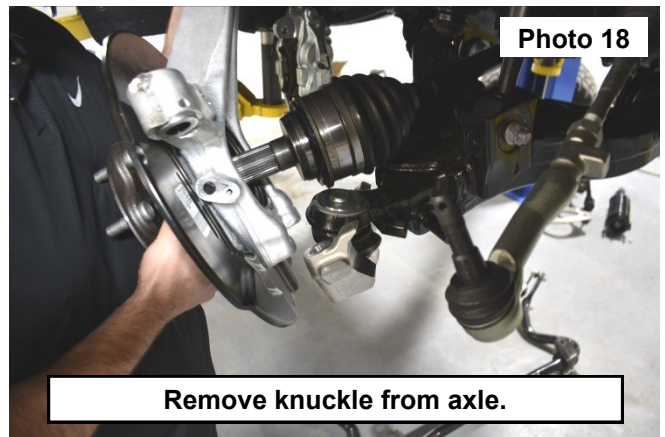
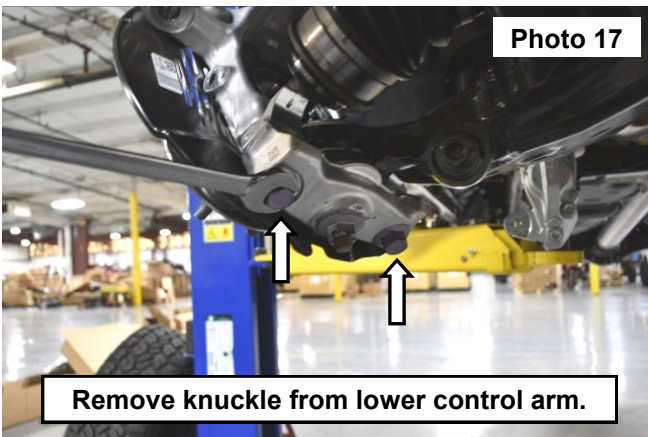

18. Remove lower strut bolt from the control arm using two 22mm wrenches. **See Photo 19.**

19. Remove the nuts from the upper strut mount using a 14mm wrench. **See Photo 20.**

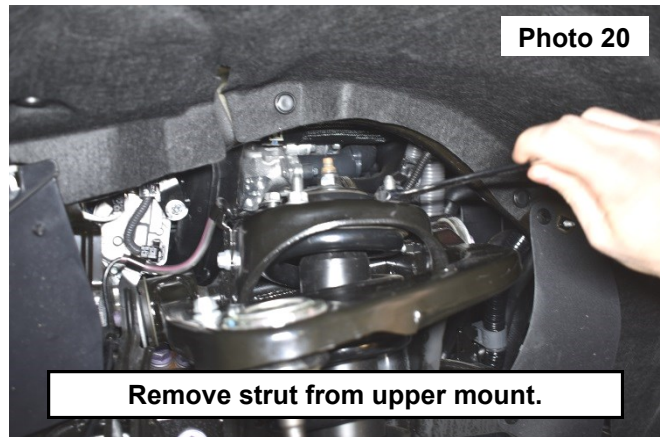
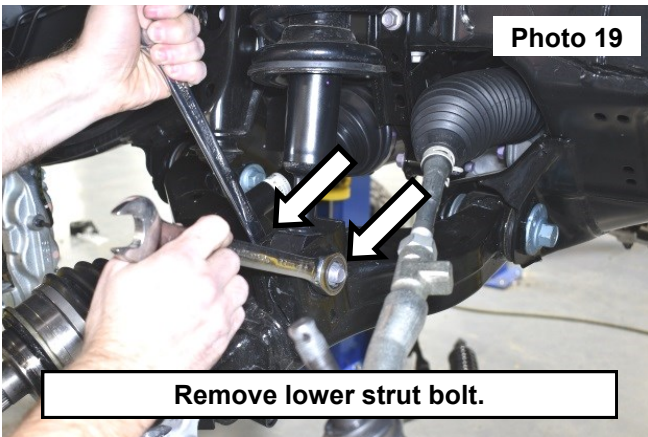

20. Remove the lower control arm cam bolts using two 24mm sockets/wrenches to remove the lower control arm and remove the strut from the vehicle. **See Photo 21.**

21. Unbolt the drive shaft using a 14mm socket. **NOTE: Make sure the drive shaft is supported -- do not let it hang down. See Photo 22.**

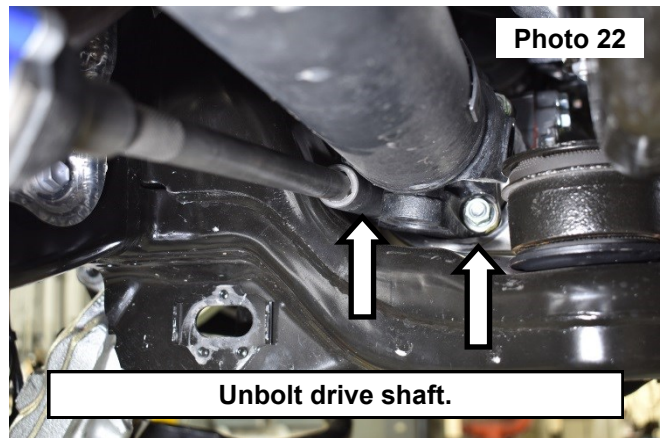
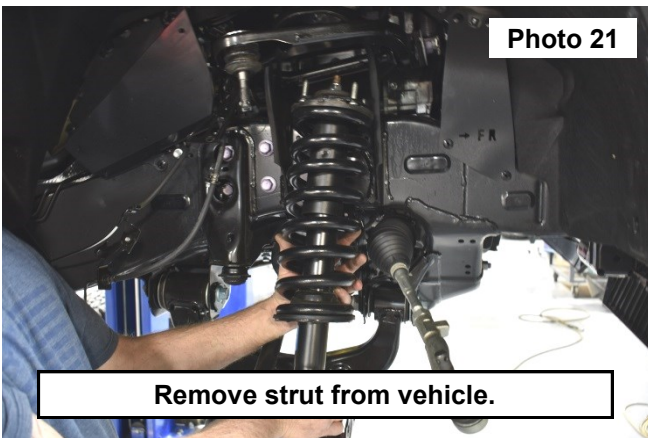

22. Support the differential with a jack stand and remove hardware on the pass side of the diff that attach the diff bracket to the frame using two 19mm sockets/wrenches. **See Photo 23.** Retain Hardware.

23. Remove the 3 bolts from the diff bracket beneath the axle using two 22mm socket/wrenches. **See Photo 24.** Retain Hardware.

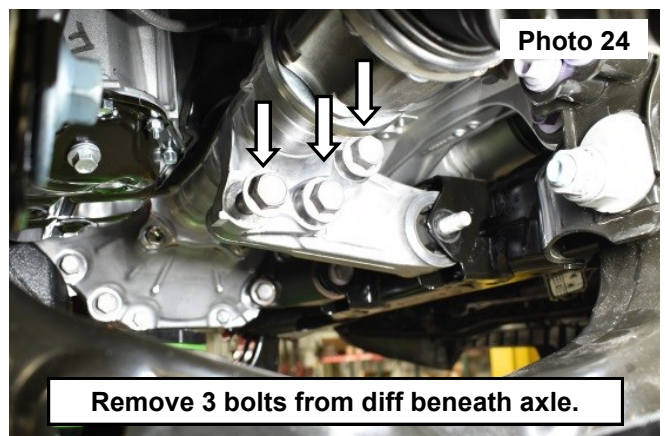
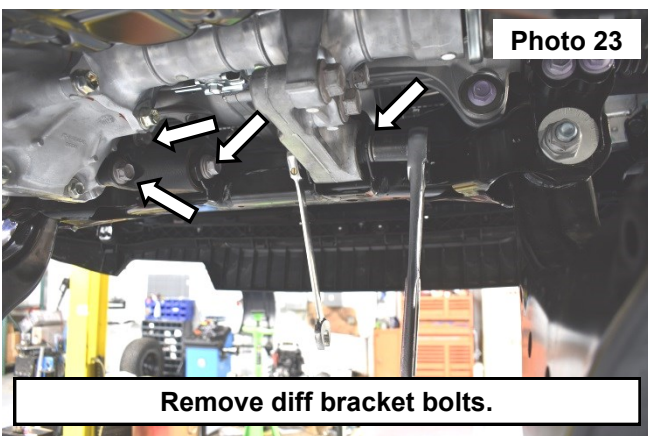

24. Unplug the diff wiring harness above the rack and pinion. **See Photo 25.**

25. Remove the rear diff bracket bolts using a 22mm socket. **See Photo 26.**

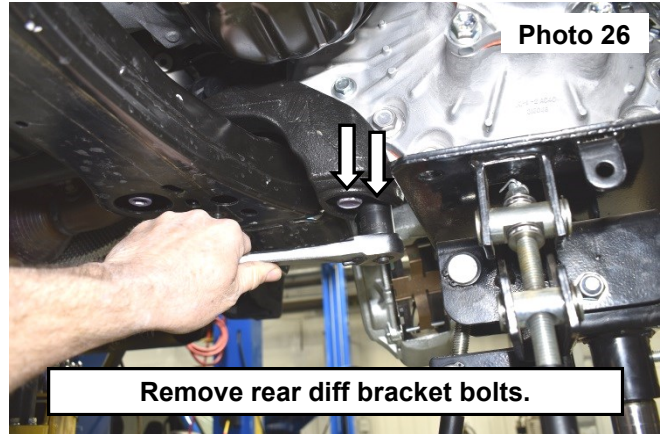
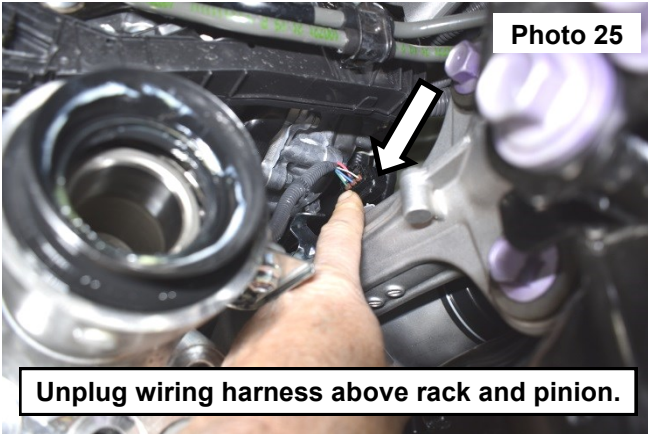

26. Remove the bolt beneath the crossmember using a 12mm Allen wrench. **See Photo 27.**

27. Remove the diff from the vehicle. **See Photo 28.** Axles were removed for picture purposes but is not required.

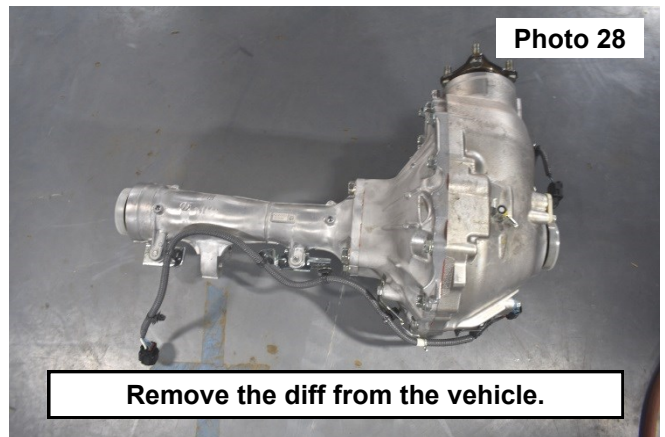
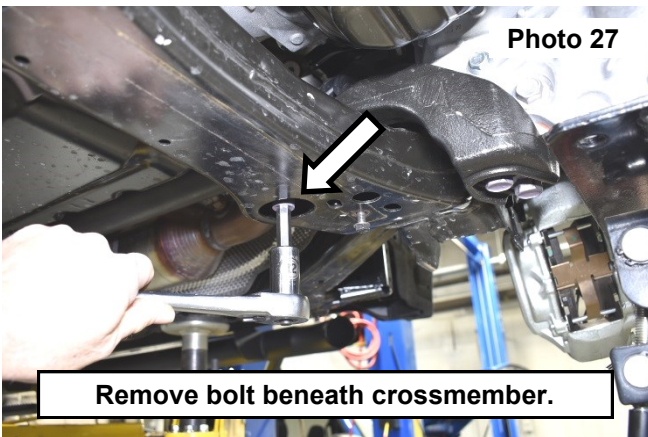

28. Mark a line using a paint pen on the Dr side of the crossmember about 3/4" from the edge. **See Photo 29.**

29. Mark another line at least 9" from the Dr side edge to make enough room for the diff to drop down. **See Photo 30.**

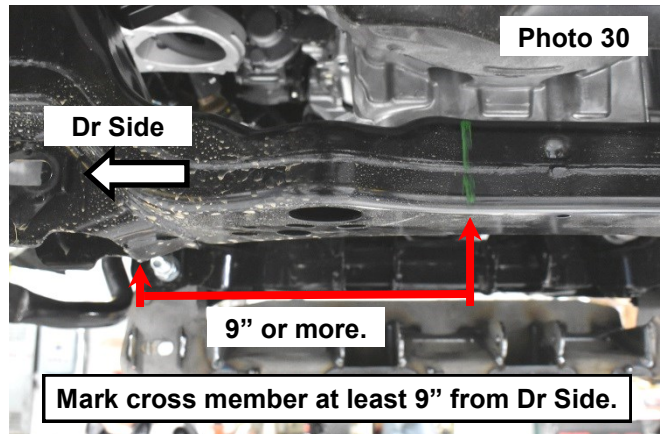
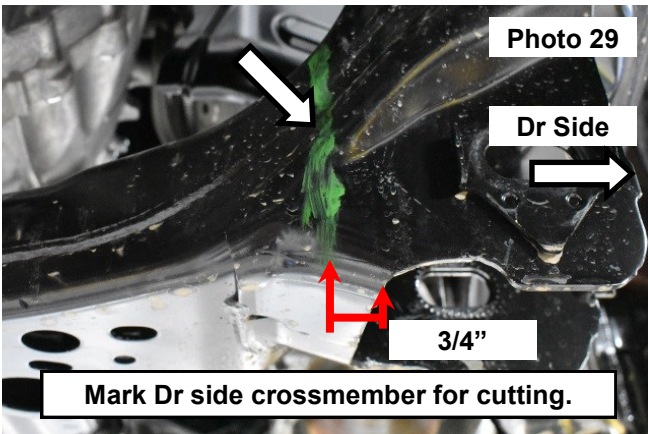

30. Cut the crossmember at the marked lines using a reciprocating saw. **See Photo 31.**
31. Grind down any sharp edges and spray paint the cut edges to prevent rusting. **See Photo 32.**

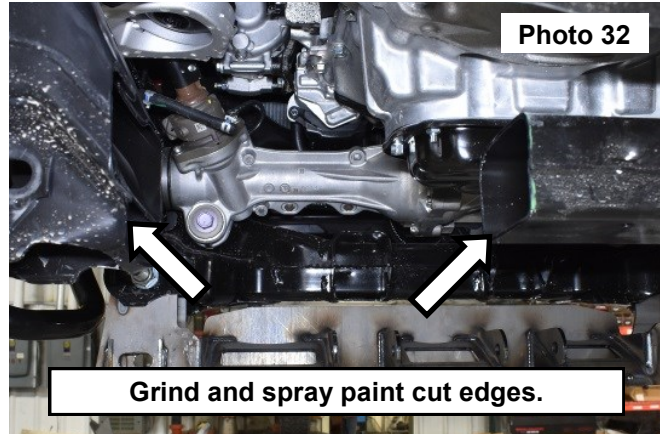
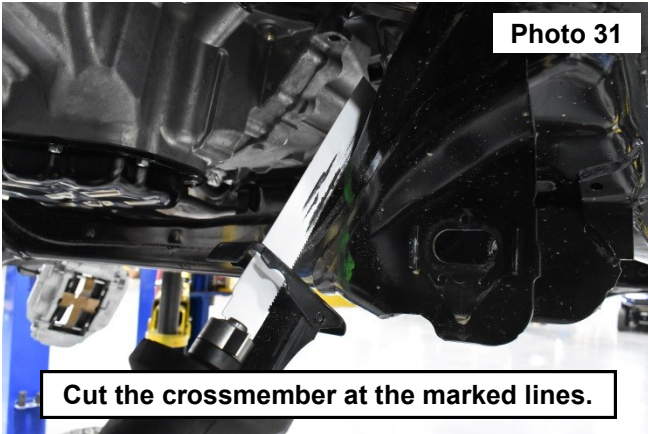

32. Install the front crossmember badge using the supplied hardware. Then install into the vehicle using the supplied hardware in the lower control arm mounting locations. Use the supplied 18mm x 140mm bolts, nuts, and washers and tighten using 1-1/16" socket/wrench. **See Photo 33.**
33. Install the stock front diff bracket into the front crossmember using OE hardware. Then raise up the diff using a jack and install diff to the front diff bracket. **See Photos 34.**

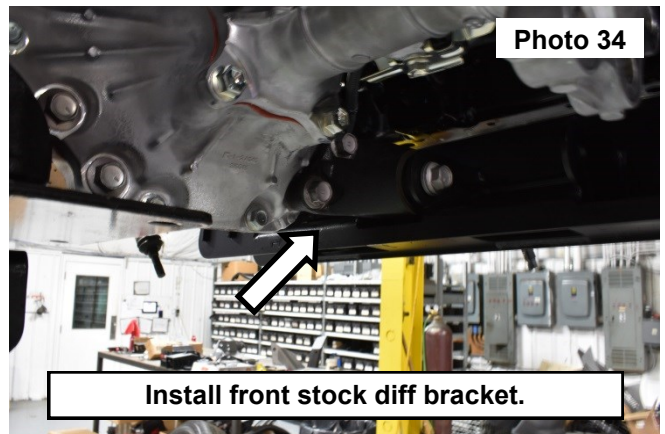
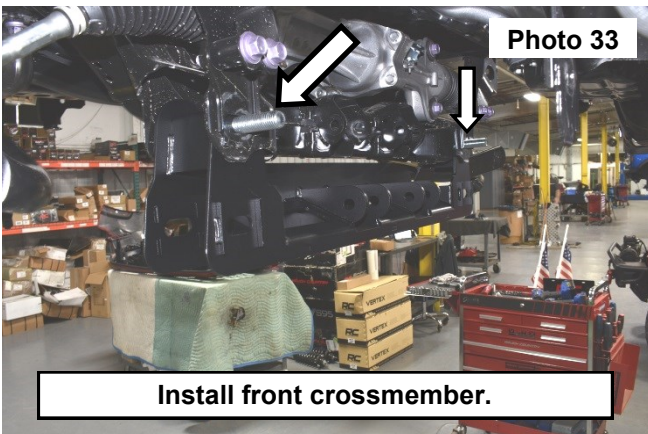

34. Install the OE rear diff bracket onto the diff using the OE hardware. **See Photo 35.**
35. Install the supplied rear crossmember in the lower control arm mounting locations. Use the supplied 18mm x 150mm bolts nuts, and washers and tighten using 1-1/16" socket/wrench. **See Photo 36.**

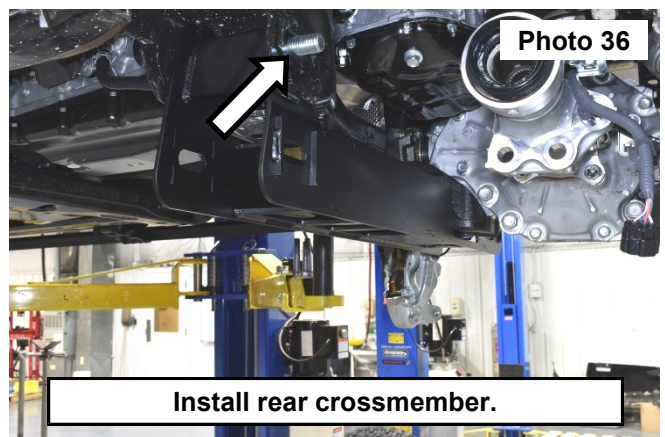
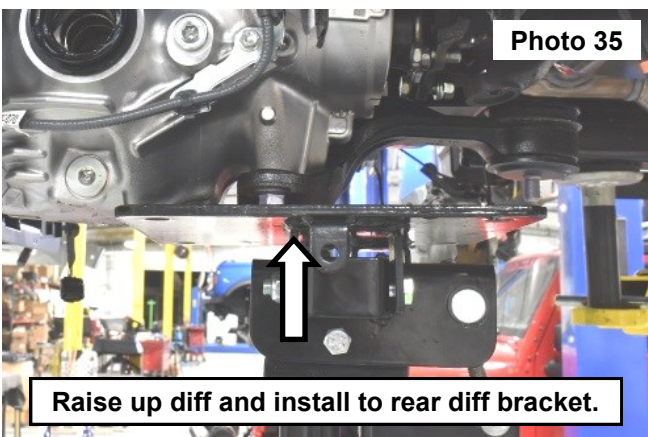

36. Secure the diff to the rear crossmember using the stock hardware. See Photo 37 and Photo 38.

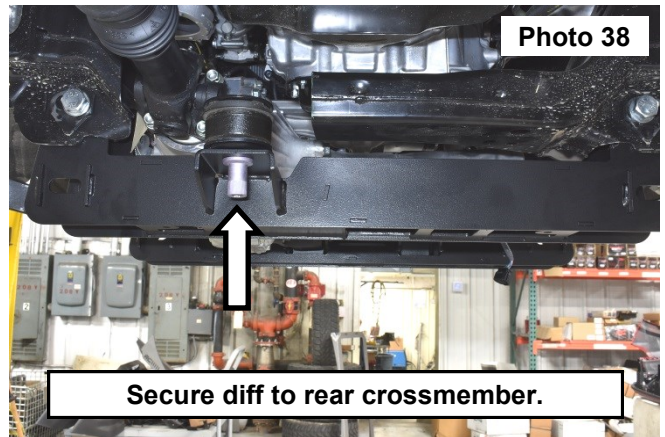
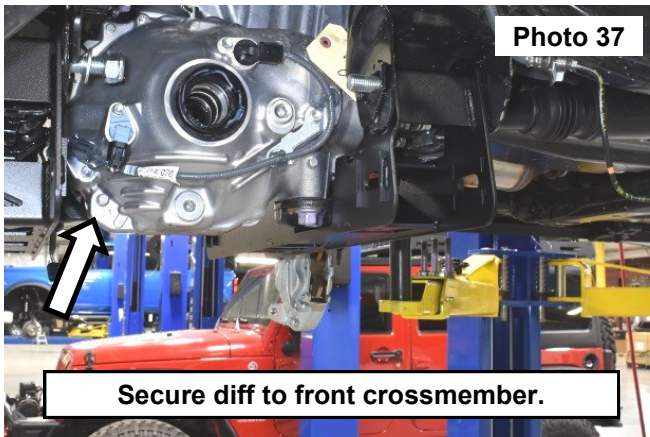

37. Install the stock diff bracket beneath the axle on the passenger side using stock hardware. See Photo 39.

38. Reinstall the drive shaft to the differential. See Photo 40.

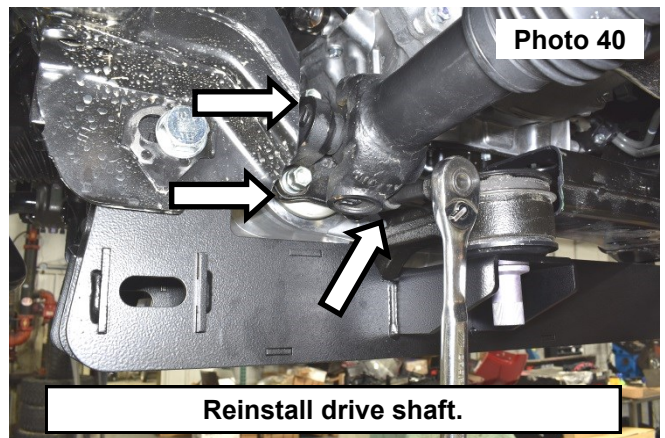
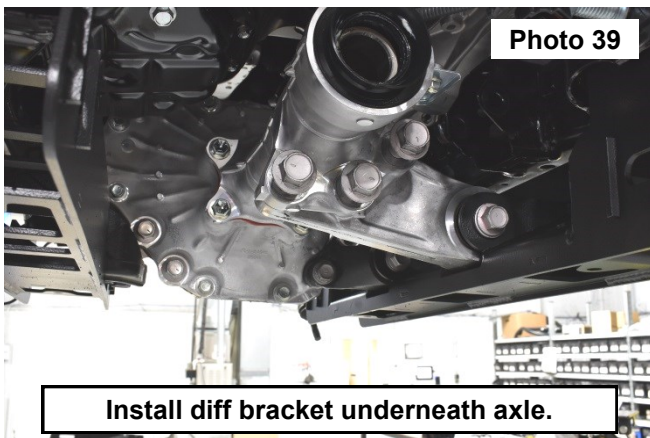

39. Reinstall the diff wiring harness above the rack and pinion. See Photo 41.

40. Install the lower control arms to the new crossmembers with the supplied 18mm x 140mm cam bolts, washers, and nuts in the front and 18mm x 160mm cam bolts, washers, and nuts in the rear using two 1-1/16" socket/wrenches. See Photo 42.

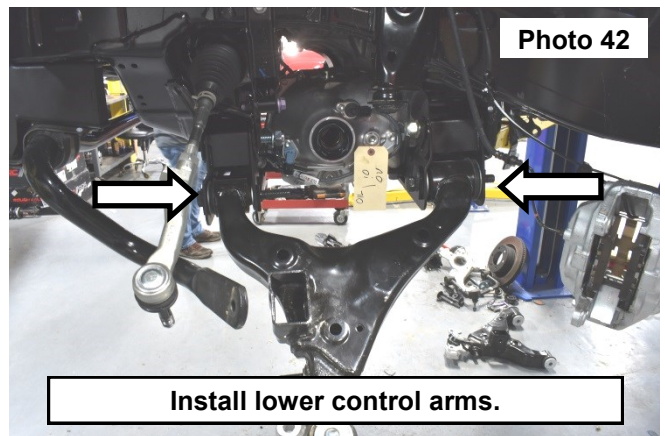
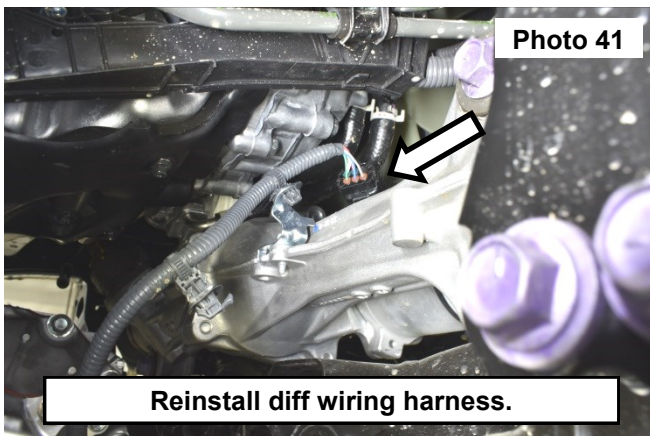

41. Remove the plastic covering over the upper brake line bracket with a flat head and remove the upper brake line bracket using a 13mm wrench. **See Photo 43.**
42. Install the upper brake line extension bracket with the stock hardware at the body and the supplied 5/16" x 3/4" bolts, flange nuts, and washers to secure the extension to the bracket using a 13mm socket/wrench. **See Photo 44.**

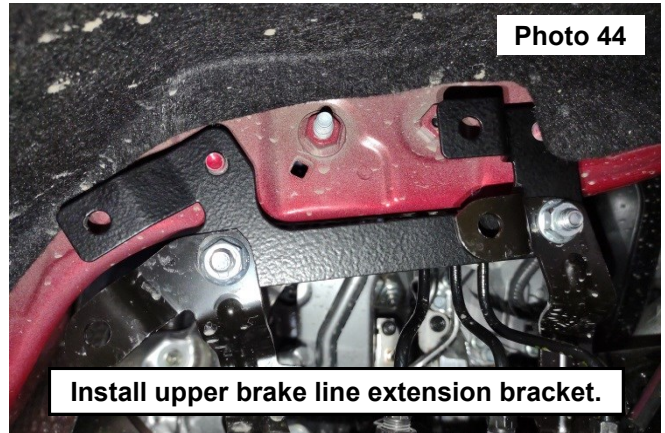
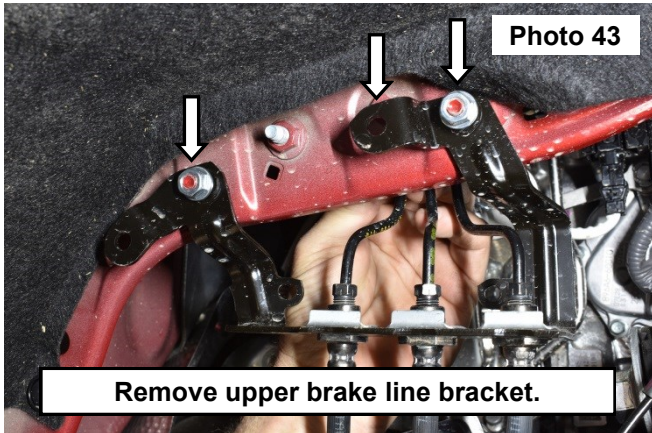

43. Remove the lower brake line bracket and install the lower brake line extension bracket with the stock hardware at the body and the supplied 5/16" x 3/4" hardware to secure the extension to the bracket using a 13mm socket/wrench. **See Photo 45.**
44. Remove the bump stop. **See Photo 46.**

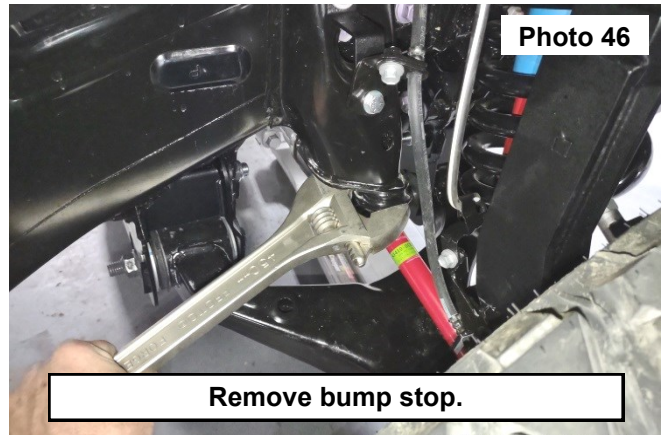
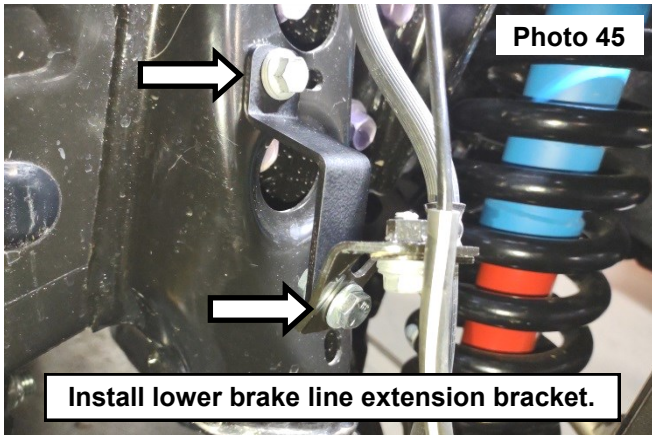

45. Install the bump stop extension to the bump stop with the supplied 10mm serrated flange nut and install extension to the vehicle using the supplied 10mm x 35mm bolt, flat washer, and lock washer. **See Photo 47.**
46. Install the sway bar drop brackets to the stock mounting location using the stock hardware and secure the sway bar to the drop brackets with the supplied 7/16" x 1-1/4" bolts, nuts, and washers using a 5/8" wrench. **See Photo 48.**

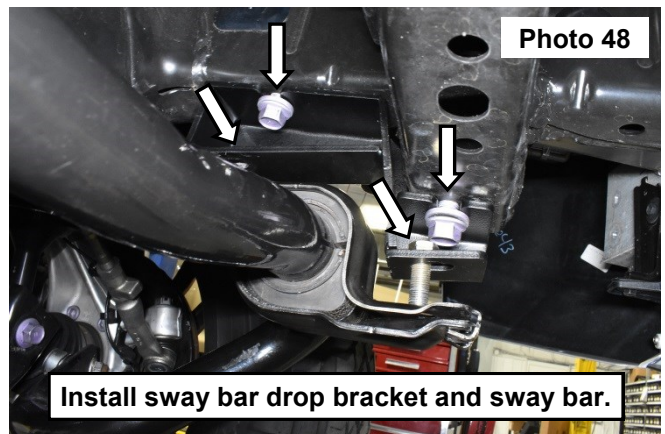
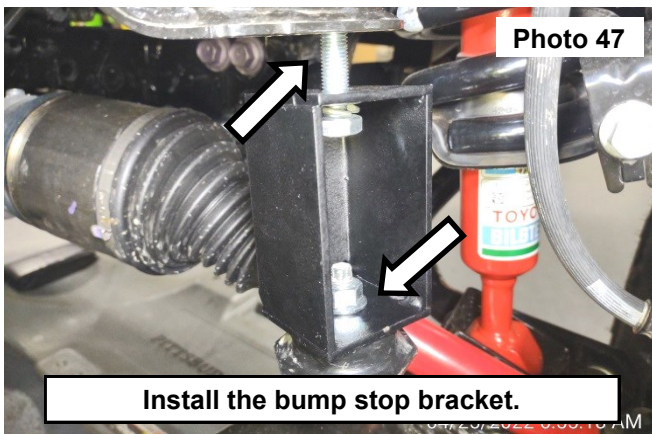

47. Install the 10mm studs (10MMSTUDBAG-2) to the upper strut spacer using the supplied hex and jam nut, and install the spacer to the strut using the stock hardware. **See Photo 49.**
48. Install the strut with the spacer using the supplied 10mm nuts (10MMSTUDBAG-2). **See Photo 50.**

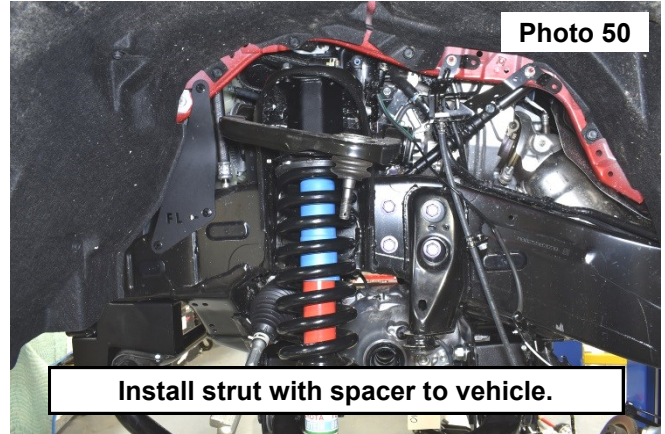
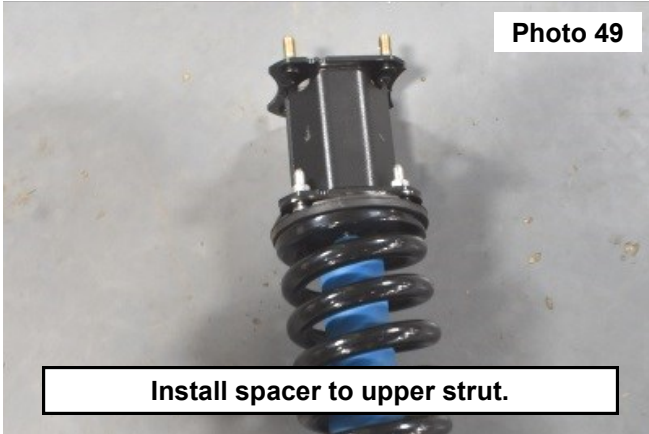

49. Install the lower strut mount to the control arm. Secure using the factory hardware, Do not fully tighten the bolt. This will be done once on the ground. **See Photo 51.**
50. Connect the lower sway link to the control arm using the OE bolt. Tighten using a 19mm socket. **See Photo 52.**

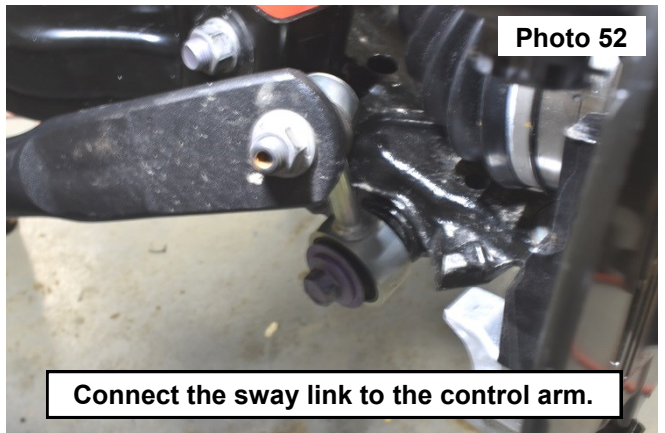
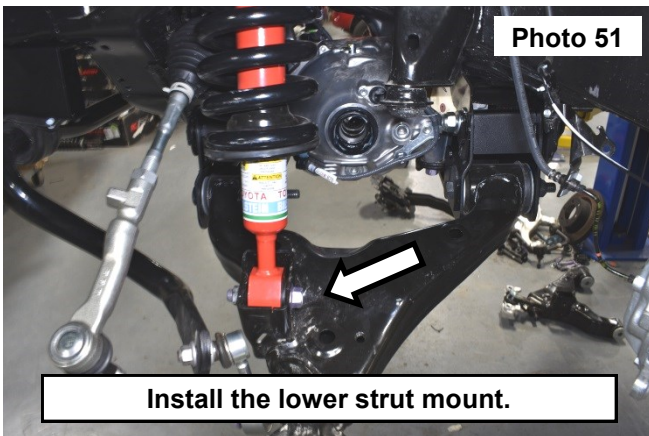

51. Install the axle into the diff. **See Photo 53.**
52. Remove the wheel bearing and dust shield from the stock knuckle. **Discard the Dust shield. See Photo 54.**

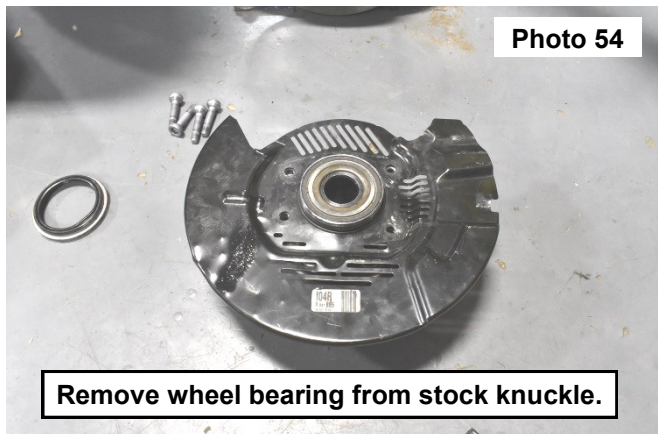
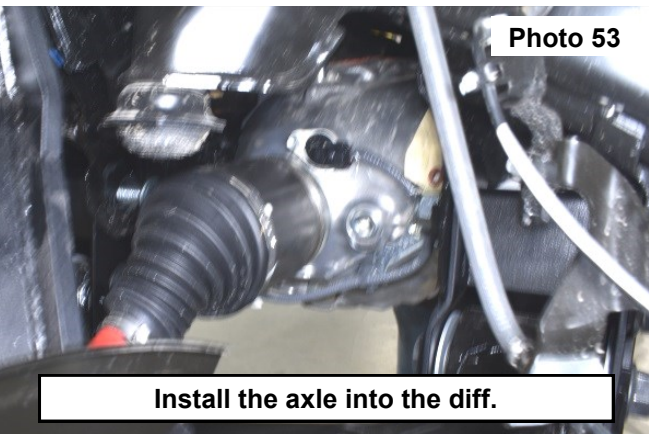

53. **Discard the Dust shield.** Install the wheel bearing spacer onto the hub, then secure the knuckle onto the hub using OE hardware. **See Photo 55.**
54. Install the axle seal ring to the knuckle using a dead blow hammer. **See Photo 56.**

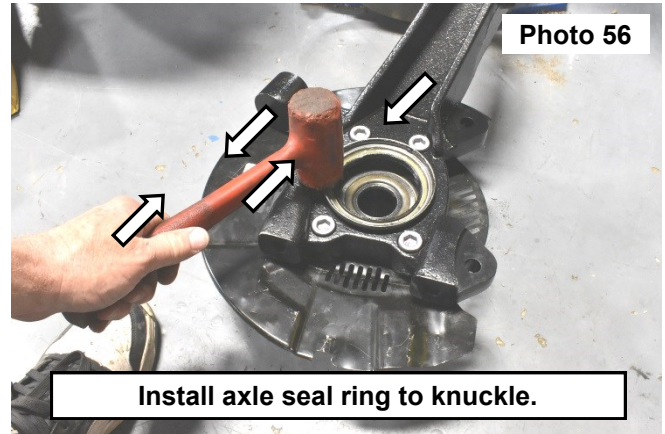
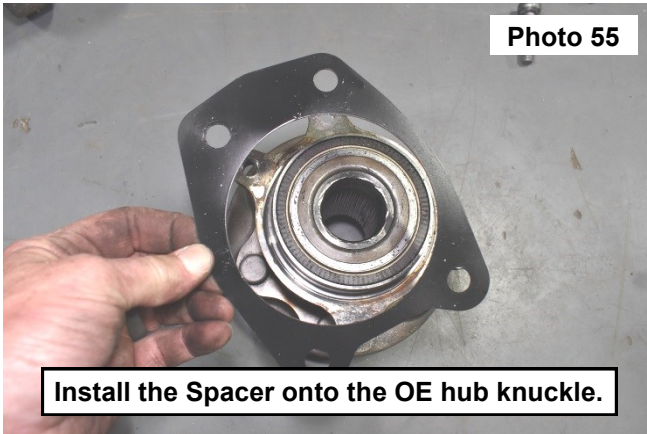

55. Place the axle into the hub in the knuckle. **See Photo 57.**
56. Install the new knuckle to the lower control arm mount. Secure using the (2) OE bolts. Tighten using a 22mm socket. **See Photo 58.**

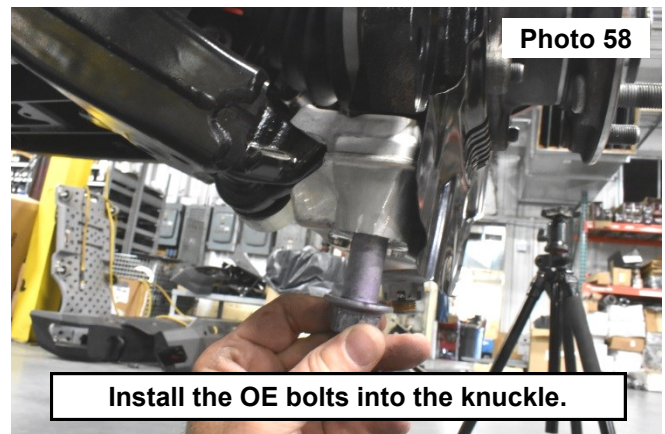
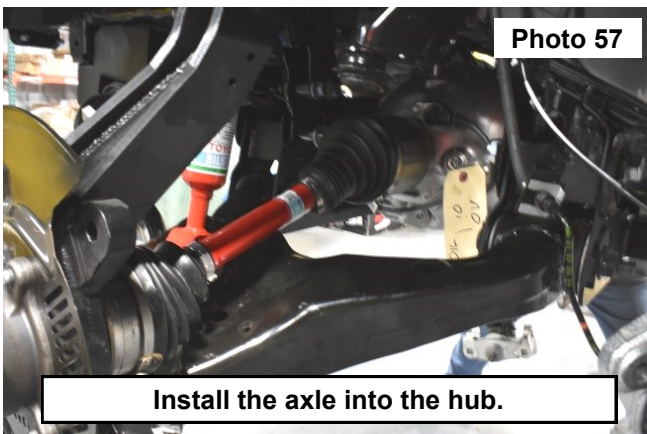

57. Support and raise up the lower control arm. Then connect the upper ball joint to the knuckle using the OE hardware. Tighten using a 19mm socket and reinstall the ball joint retaining clip. **See Photo 59.**
58. Secure the axle using the OE axle nut. Tighten using a 43mm socket. **See Photo 60.**

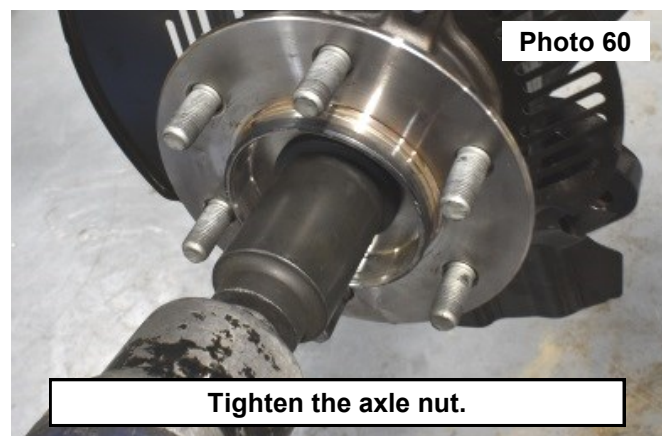
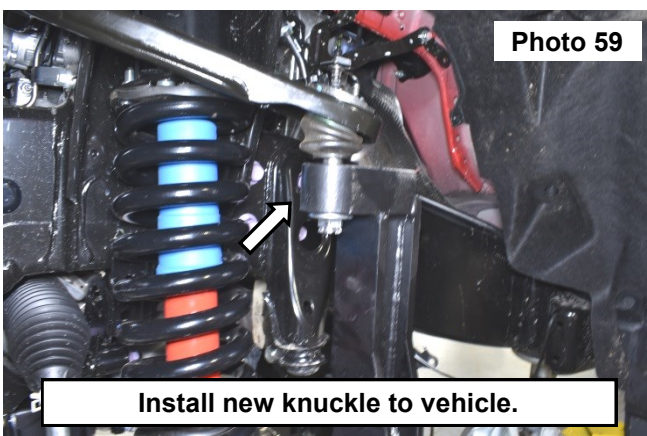

59. Install the locking ring and cotter pin onto the axle. **See Photo 61.**

60. Install the dust cover onto the hub. **See Photo 62.**

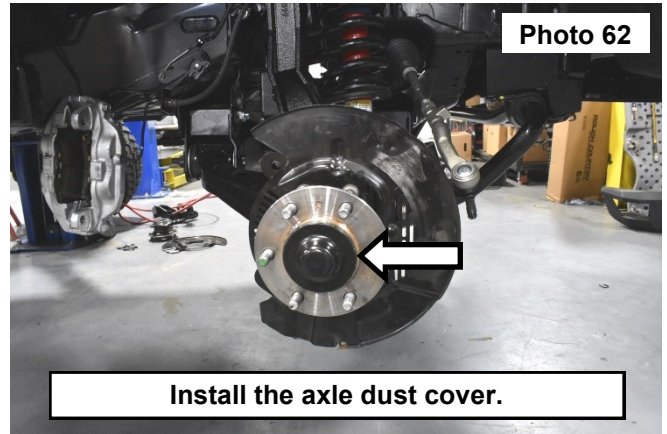
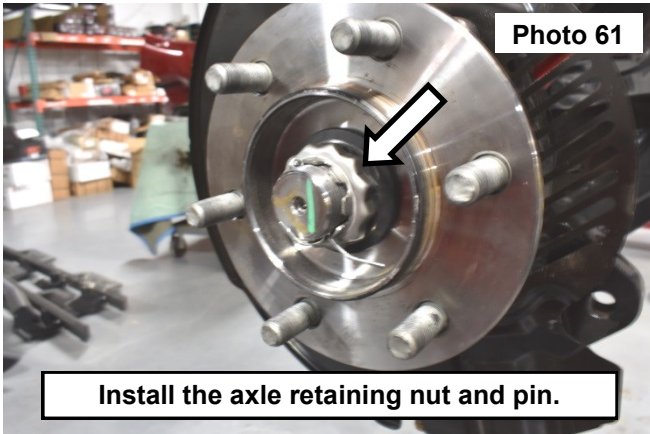

61. Install the rotor and brake caliper onto the knuckle. Secure the brake caliper using the (2) OE bolts. Tighten using a 19mm socket. **See Photo 63.**

62. Install the tie rod end into the knuckle. Tighten using a 24mm wrench. **See Photo 64.**

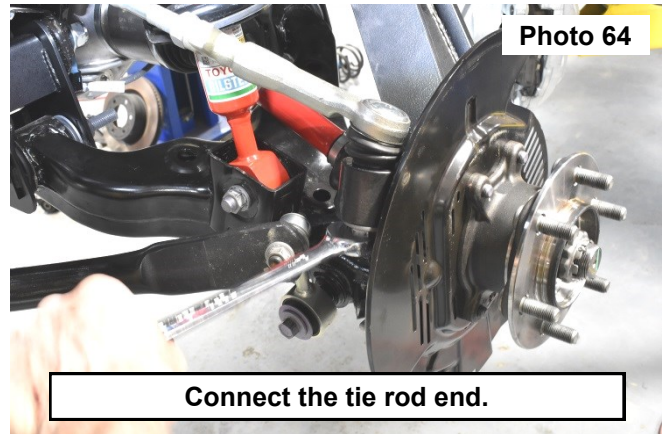
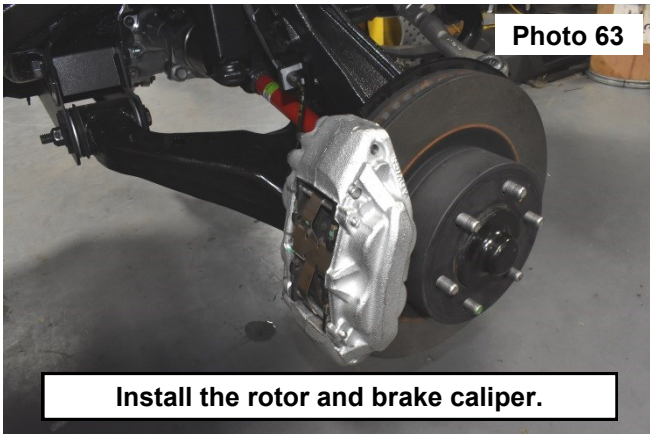

63. Install the ABS sensor and wiring harness onto the knuckle. Tighten using a 10mm socket. **See Photo 65.**

64. Install the brake line bracket to the knuckle. Tighten using a 10mm socket. **See Photo 66.**

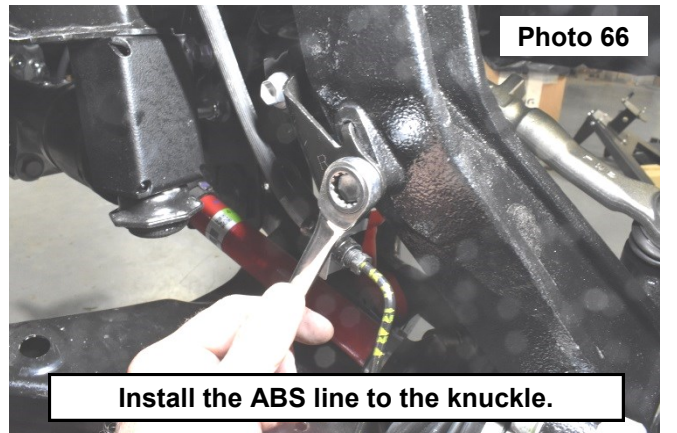
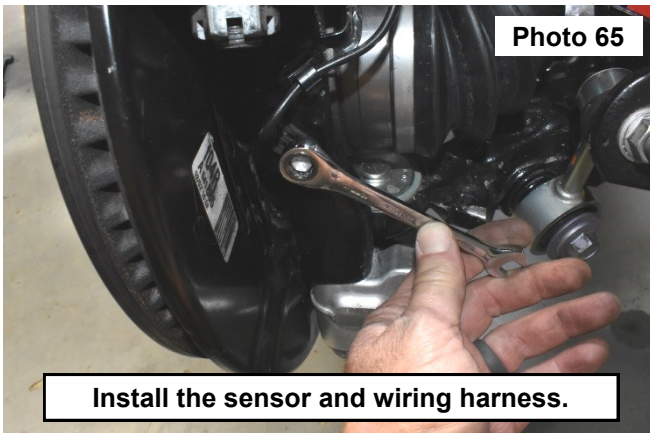

65. Install the new front skid plate using stock hardware. **See Photo 67.**

66. Install the new lower skid plate using the supplied 3/8" x 1-1/4" Bolts using a 9/16" socket/wrench. **See Photo 68.**

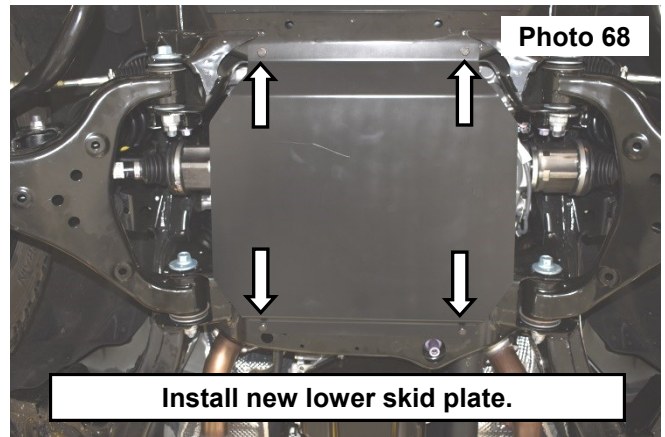
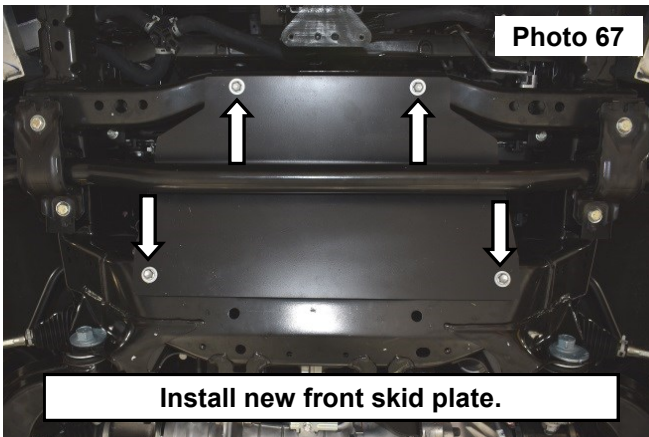

67. Reinstall the air dam. **See Photo 69.**

68. Mark the overlap of the air dam over the sway bar bracket. **See Photo 70.**

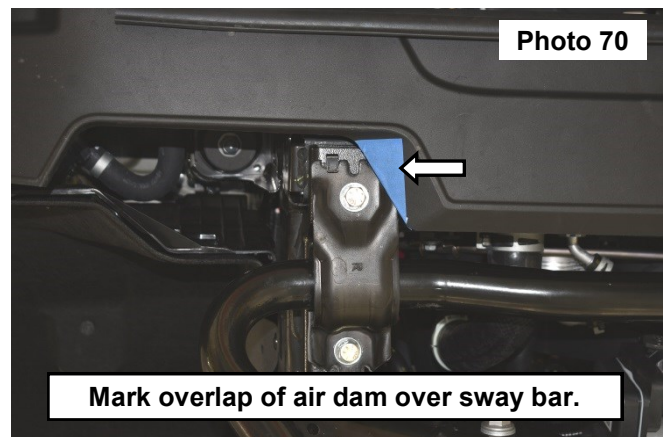
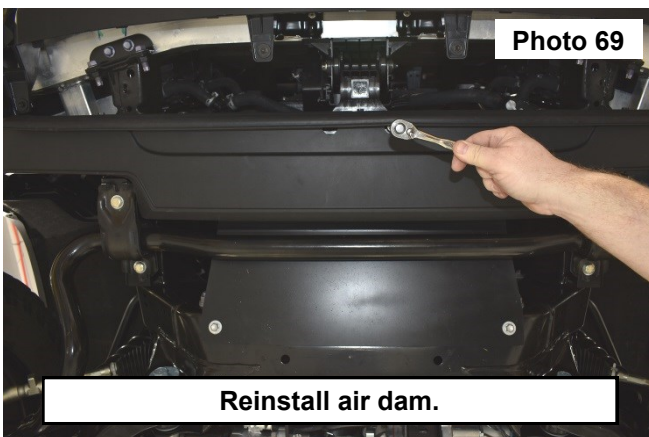

69. Trim the overlapped area on the air dam, Shown clearing the sway bar drop. **See Photo 71.**

70. Install the wheels and tires onto the vehicle. Using a jack lift up and remove the jack stands.

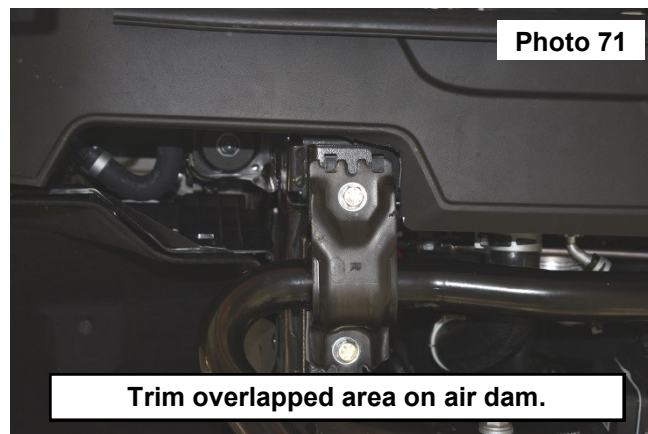



REAR INSTALLATION INSTRUCTIONS

1. Jack up the rear of the vehicle and place on jack stands. Remove the rear wheels.
NOTE: Support the axle before beginning tear down.
2. Remove the driveshaft hoop using a 14mm socket/wrench. **See Photo 1.**
3. Remove the ABS and e-brake wiring harness from the axle on the Dr and Pass sides using a 12mm socket/wrench. **See Photo 2.**

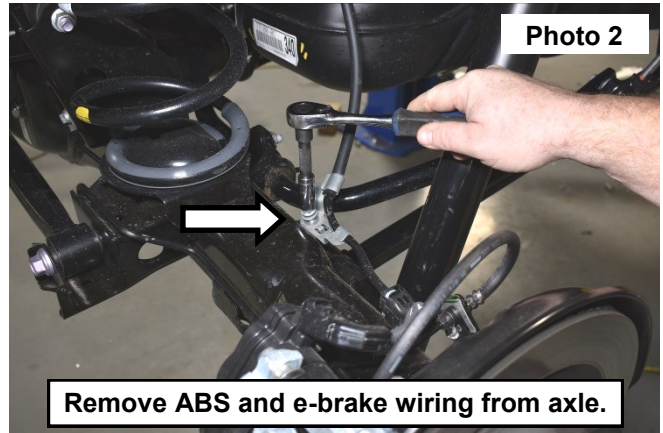
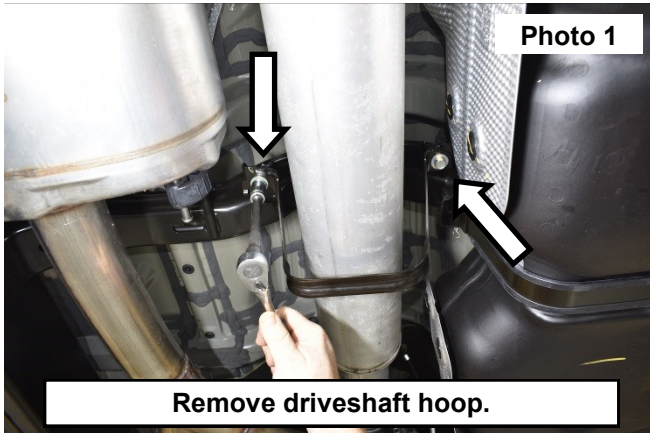

4. Remove the brake line bracket from the frame using a 12mm socket/wrench. **See Photo 3.**
5. Remove the track bar bolt using a 19mm socket/wrench. **See Photo 4.**

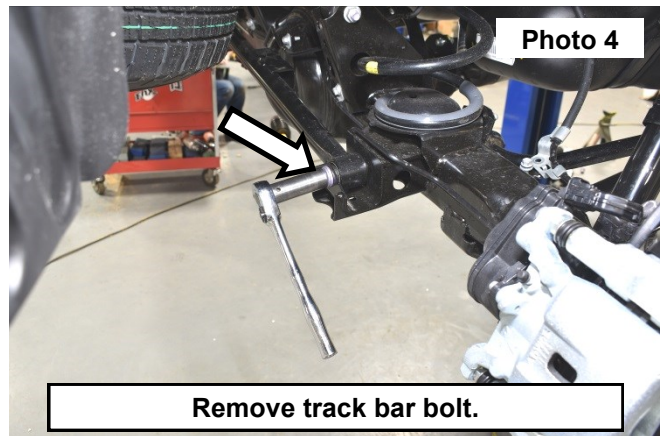
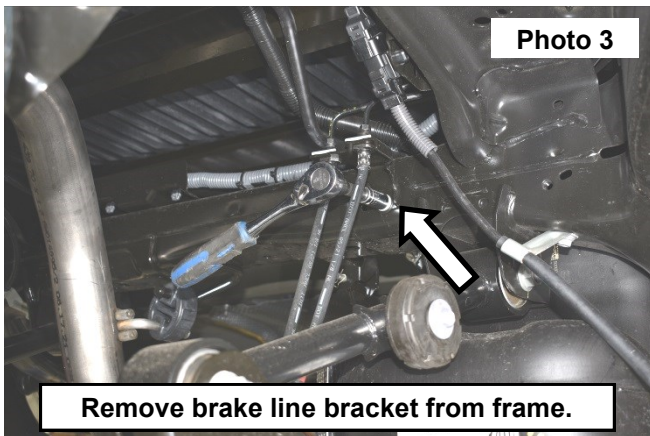

6. Remove the sway bar link nut on Dr and Pass sides using a 17mm socket/wrench. **See Photo 5.**
7. Remove the upper shock nut using a 19mm wrench and 8mm wrench to hold the stem. **See Photo 6.**

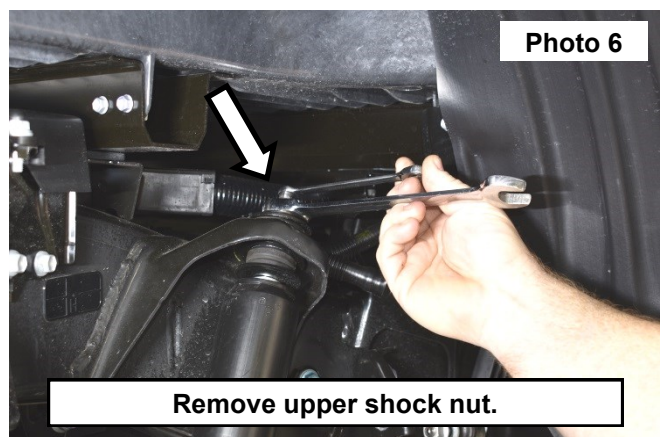
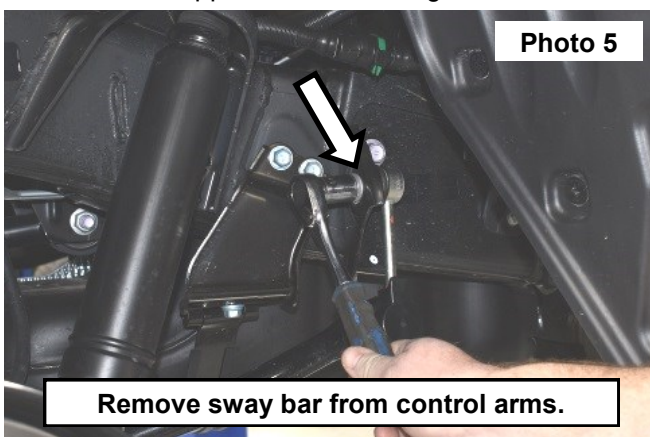

8. **Support rear axle to prevent damage to ride height sensor bracket on passenger upper control arm.** Remove the lower shock bolt using a 17mm socket/wrench. **See Photo 7.**
9. Either lower the axle or raise the vehicle to remove the spring from the vehicle. **See Photo 8.**

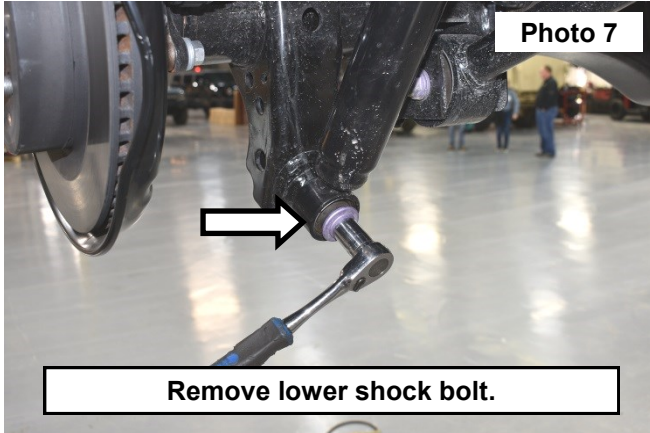

Remove lower shock bolt.

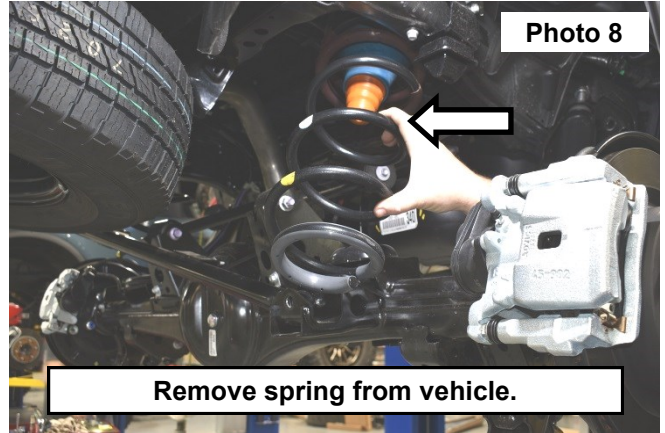

Remove spring from vehicle.

▲ NOTICE 10. Remove the upper control arm bolt at the axle. **See Photo 9.**

For 4" kit, skip steps 11 and 12.

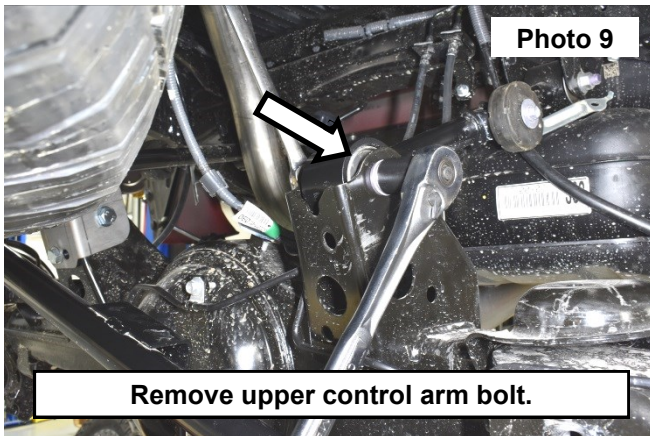

Remove upper control arm bolt.

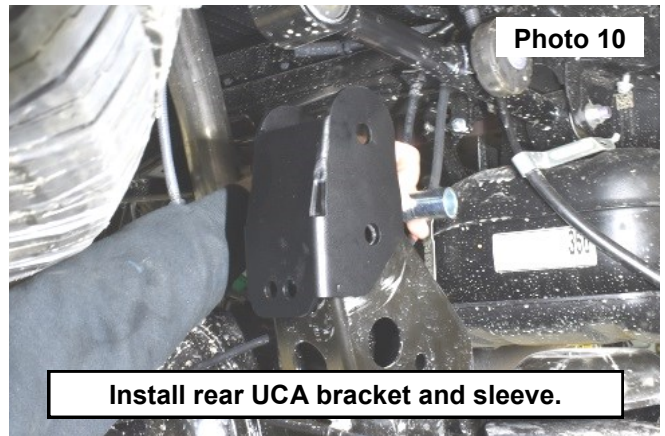

Install rear UCA bracket and sleeve.

11. Install the rear upper control arm relocation brackets and the 1" x 2.75" sleeve. **See Photo 10.**

12. Secure the rear upper control arm bracket using the supplied 14mm x 110mm bolt, nut, and washers (21mm socket/wrench), supplied 12mm x 35mm bolt, flange nut, and washer (18mm socket/wrench), and stock hardware. **See Photo 11.**

▲ NOTICE

Steps 13- 16 are for factory shocks only. If installing supplied Rough Country shocks reuse factory hardware and skip to step 17.

13. Install lower shock bracket using stock hardware. Do not fully tighten. **See Photo 12.**

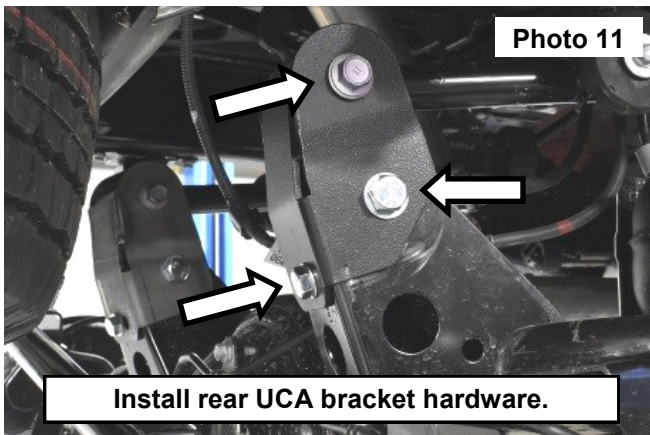

Install rear UCA bracket hardware.

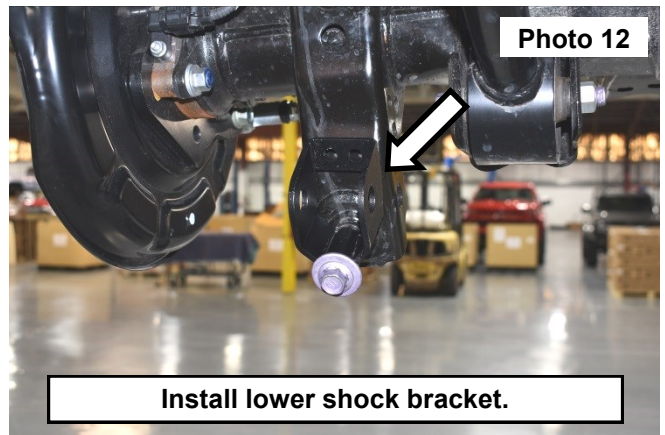

Install lower shock bracket.



14. Insert the 3/4" x 3.5" bolt through lower shock bracket and hang the shock bracket brace on bolt. **See Photo 13.**
15. Secure the shock bracket brace with the supplied flag nut and 1/2" x 1.25" bolt using a 3/4" socket/wrench. **See Photo 14 and Photo 15.**

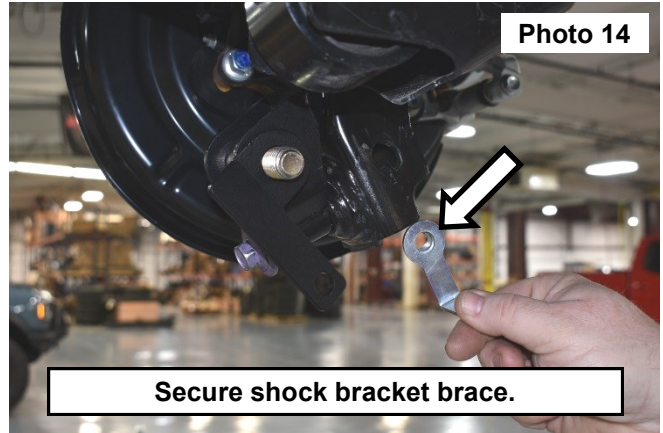
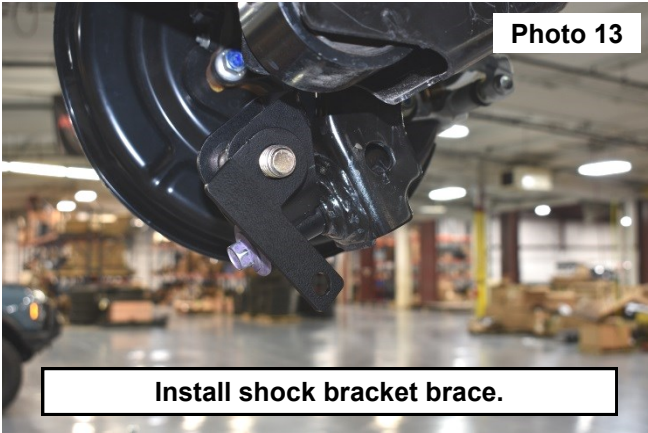

16. Install the shock to the lower shock extension with the 3/4" bolt, nut and washer using two 1-1/8" sockets/wrenches. **See Photo 16.**

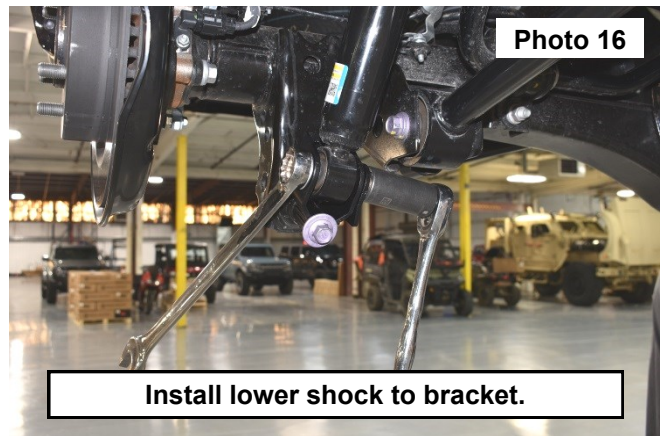
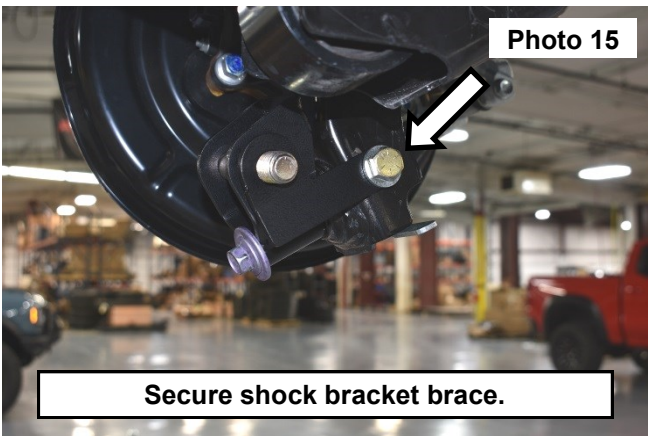

17. Place track bar bracket shim on the stock track bar bracket location with hole toward Pass side. **See Photo 17.**
18. Install the track bar bracket with the supplied 10mm x 35mm bolt, washer, and flange nut using a 15mm and 17mm socket/wrench. Slide the supplied 10mm flange nut inside of the factory track bar bracket. **See Photo 18.**

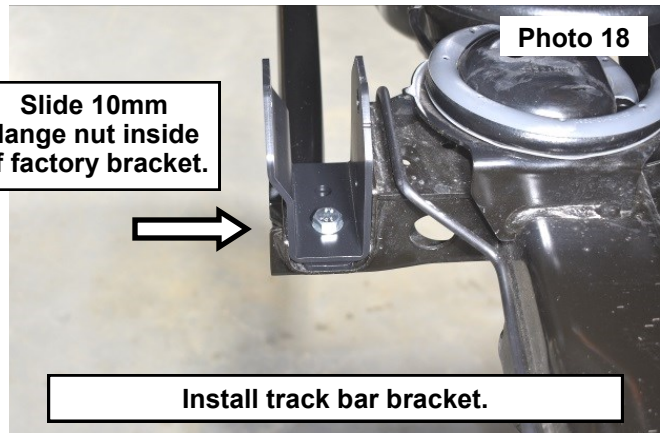
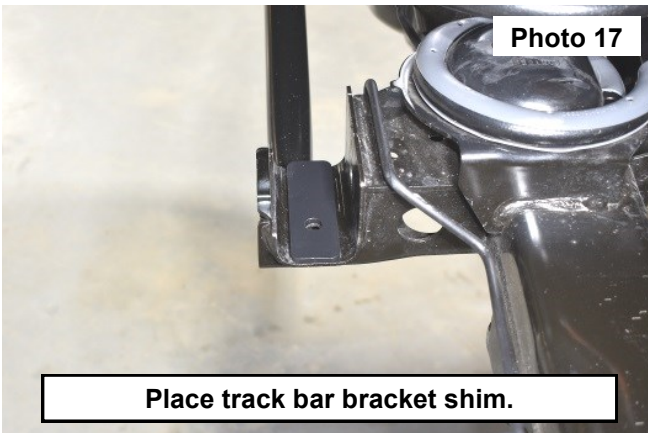

19. Install the 9/16" x 1-5/8" sleeve in the track bar bracket using the stock hardware. **See Photo 19.**
20. Install the track bar to the track bar bracket using the supplied 14mm x 80mm bolt and nut using two 22mm sockets/wrenches. **See Photo 20.**

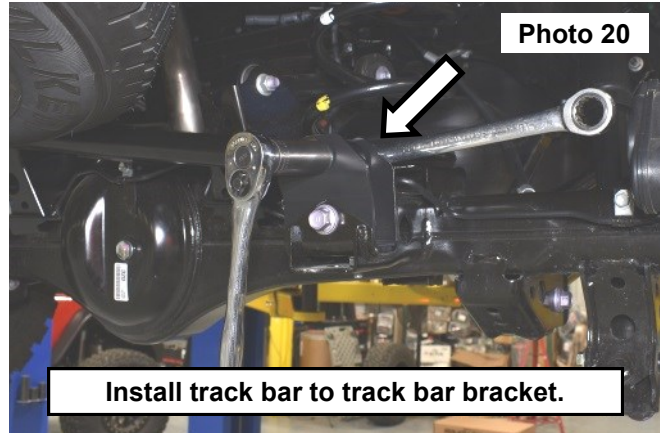
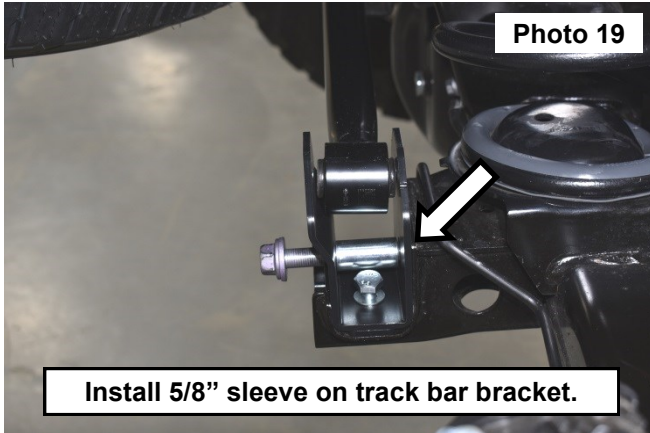

21. Remove the stock sway bar link brackets using a 17mm socket/wrench. **See Photo 21.**
22. Install the supplied rear sway bar drop brackets for the Pass and Dr side using the stock hardware. **See Photo 22.**

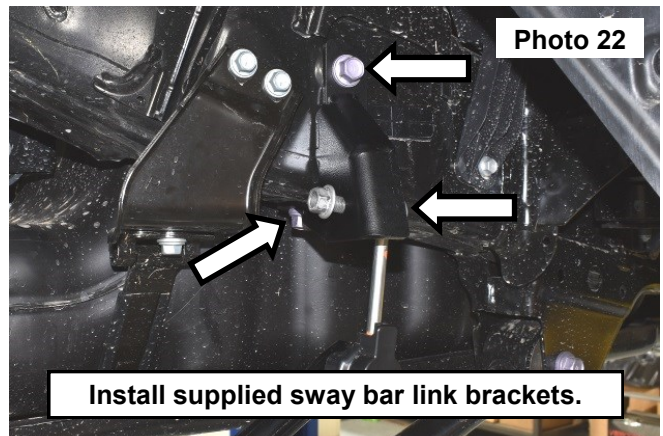
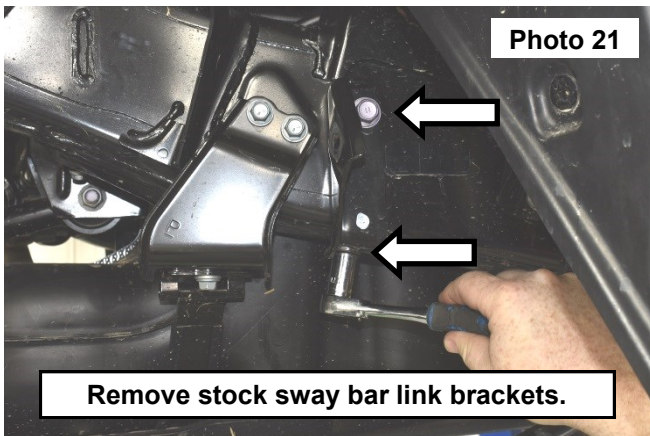

23. Install the supplied upper coil spacer to the vehicle with the supplied 10 x 35mm bolts, flat washers and flange nuts using a 16mm socket/wrench. **See Photo 23.**
24. Reinstall the spring with the spacer. **See Photo 24.**

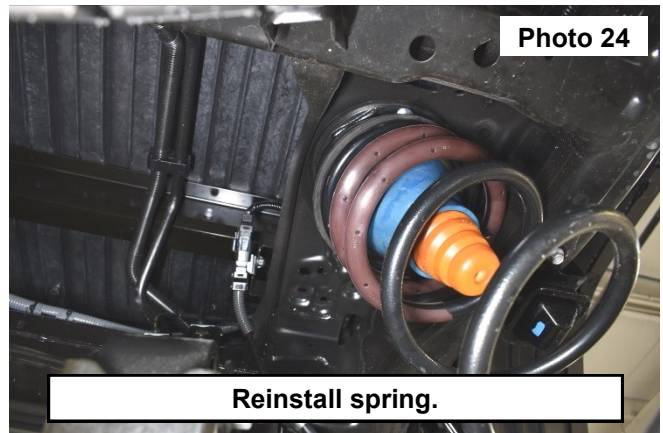
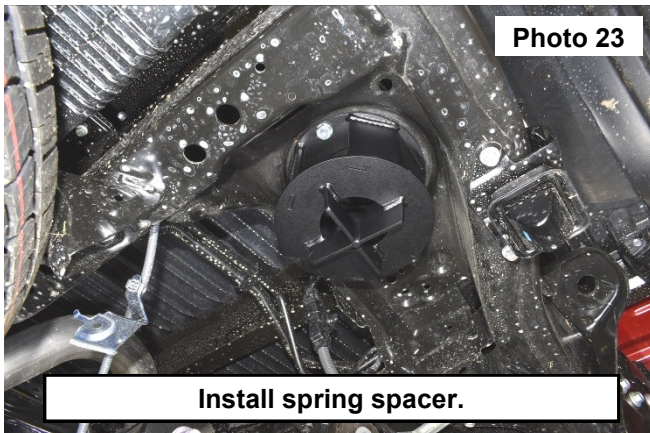

25. Remove the stock bump stop using a 12mm socket/wrench. **See Photo 25.**
 26. Install the supplied bump stops to the RC bump stop bracket with the supplied 3/8" flat washer, lock washer, and nut. **See Photo 26.**

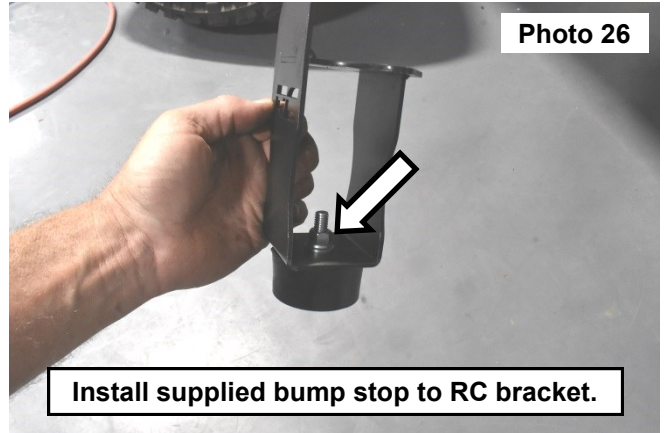
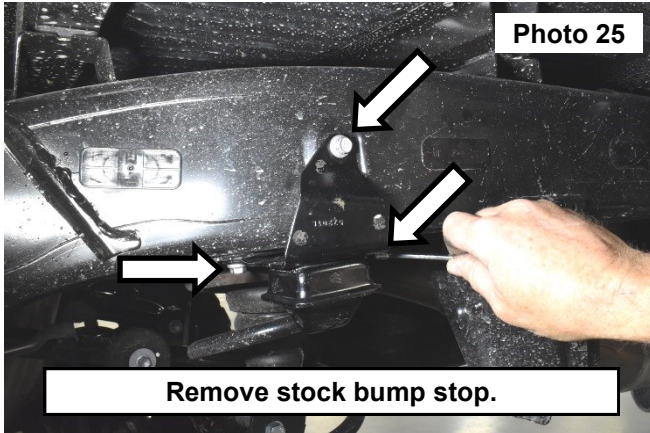

27. Install the new bump stop in the stock location using the stock hardware. **See Photo 27.**
 28. Install the supplied brake line brackets on the passenger side, driver side, behind the spare tire, and above the drive

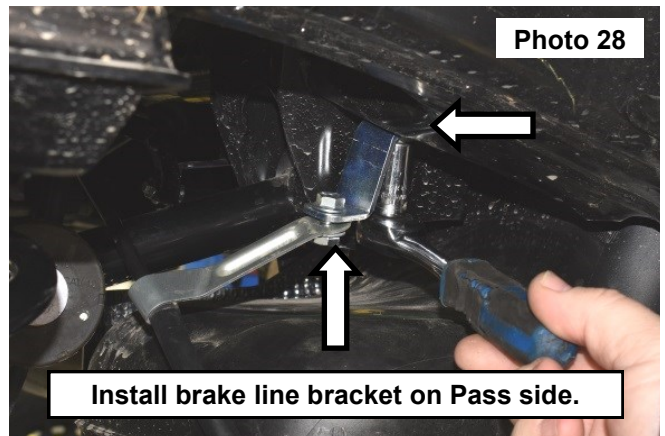
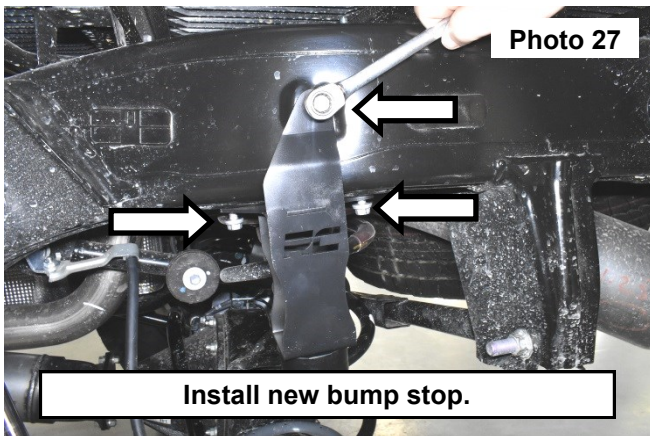

shaft with the stock bolts at the frame and the supplied 5/16" x 3/4" bolts, washer, and nut at the brake lines using 1/2" socket/wrench. **See Photo 28, 29, 30, and 31.**

NOTE: Make sure brake lines do not rub against the top of the frame by bending away from frame slightly.

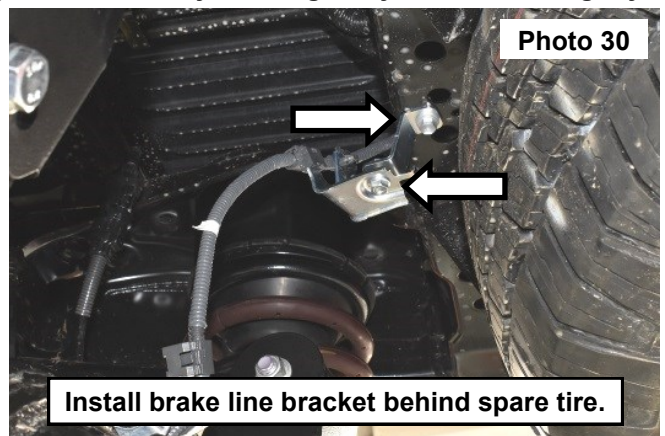
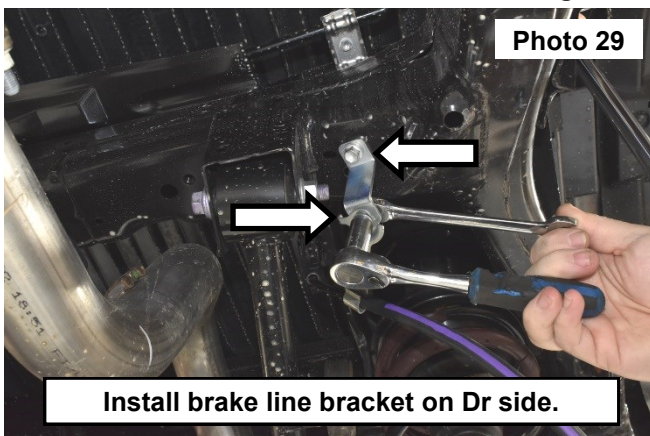

29. Reinstall the drive shaft loop with the cylindrical spacers. See Photo 26.

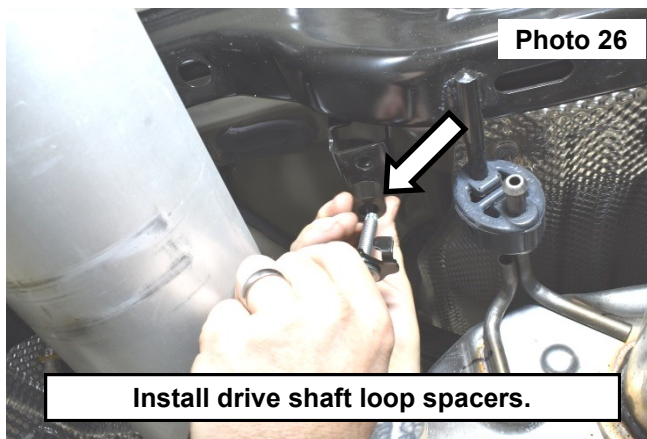
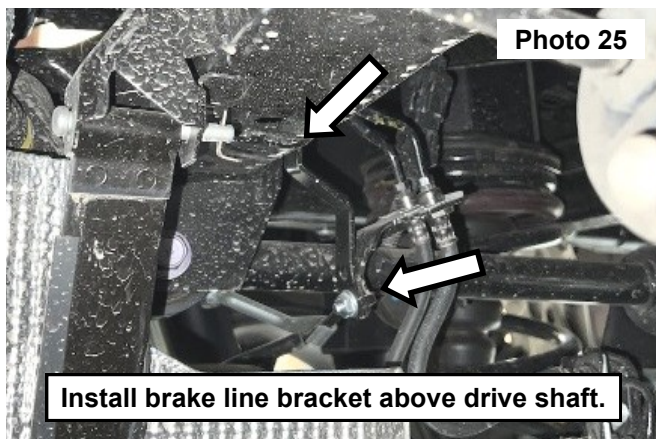

30. Reinstall the remainder of the components in reverse order of tear down.

31. Put on wheels and lower.