

921510070

ROUGH COUNTRY

SUSPENSION SYSTEMS®



51007BAG

27.11
(688.7 mm)

FORD 2015-19 F-150 Hidden Winch

Thank you for choosing Rough Country for all your vehicle needs.

Please read instructions before beginning installation. Check the kit hardware against the kit contents shown below. Be sure you have all needed parts and know where they go.

If question exist, please call us @1-800-222-7023. We will be happy to answer any questions concerning this product.

Check all fasteners for proper torque. Check to ensure for adequate clearance between all components.

Periodically check all hardware for tightness.

KIT CONTENTS:

- 2- Winch Plate Gusset Straps
- 1- Winch Plate
- 1- Hidden Winch Cover Plate
- 1- Winch Extension Cable

HARDWARE INCLUDED:

- 1/2-13 x1.5 Hex Head Bolts x4
- 1/2" SAE Washers x8
- 1/2-13 Nylock Nuts x4
- #8-32 x1.0 Socket Head Bolt x2
- #8-32 Nylock Nut x2

License Plate Hardware

- 1/4-20 x 1/2" Bolts x2
- 1/4-20 Nylock Nuts x2

TOOLS NEEDED:

- 9mm Wrench
- 15mm Socket
- 16mm Wrench
- 18mm Socket
- 19mm Wrench and Socket
- 21mm Wrench and Socket
- 9/64 Allen Wrench
- Torque Wrench
- Auto Trim Puller
- Ratchet
- Body Saw
- Wheel Chocks
- Sander or File



Torque Specs:

Size	Grade 5	Grade 8	Size	Class 8.8	Class 10.9
5/16"	15 ft/lbs	20ft/lbs	6MM	5ft/lbs	9ft/lbs
3/8"	30 ft/lbs	35ft/lbs	8MM	18ft/lbs	23ft/lbs
7/16"	45 ft/lbs	60ft/lbs	10MM	32ft/lbs	45ft/lbs
1/2"	65 ft/lbs	90ft/lbs	12MM	55ft/lbs	75ft/lbs
9/16"	95 ft/lbs	130ft/lbs	14MM	85ft/lbs	120ft/lbs
5/8"	135ft/lbs	175ft/lbs	16MM	130ft/lbs	165ft/lbs
3/4"	185ft/lbs	280ft/lbs	18MM	170ft/lbs	240ft/lbs



INSTALLATION INSTRUCTIONS

1. Chock the rear wheels of the vehicle and disconnect the battery cables.
2. Disconnect the plugs from the fog lights on each side of the vehicle. **See Photo 1.**
3. Remove the wiring from the back side of the bumper. Use an auto trim puller. **See Photo 2.**

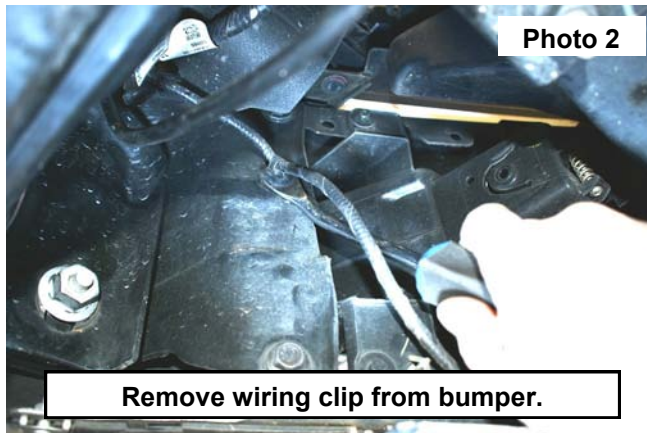

4. Remove the nut from the back side of the driver and passenger side bumper, using a 21mm socket. **See Photo 3.**
5. Remove the center cover from the bumper, using an auto trim puller. Use caution not to break the tabs holding the clips onto this part, it will be reused. **See Photo 4.**



6. Using a paint pen mark around the nuts on each side to help align the bumper when installed. **See Photo 5.**
7. Remove the 2 nuts on each side of the bumper, retain the nuts and bolt plate on the back side of the mount. Save for reuse. **See Photo 6.**

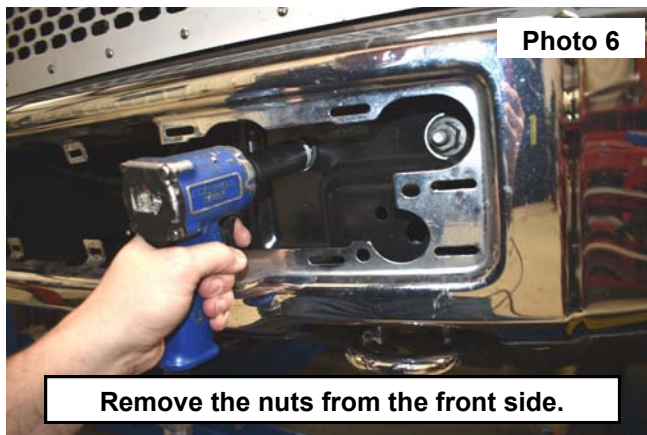
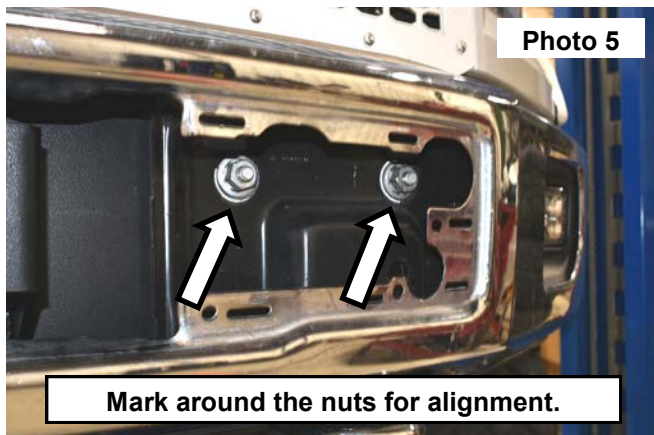

8. Remove the front bumper, set aside for reuse. **See Photo 7.**
9. Remove the 2 bolts from the tow hook, use a 15mm socket, retain the tow and the bolts for reuse. **See Photo 8.**

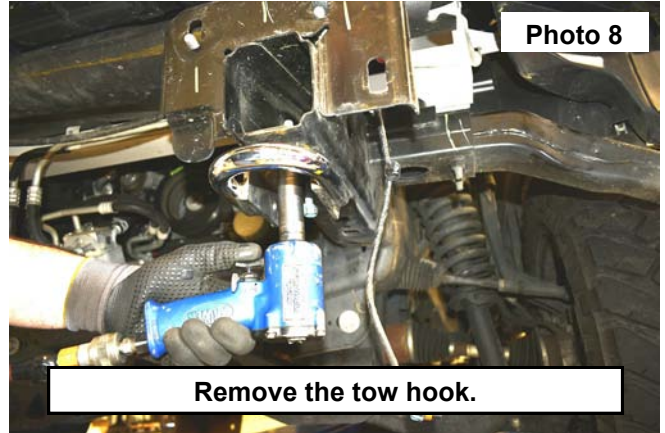

10. Locate the tow hook gusset strap shown in **photo 9**. this will be installed in between the frame and the tow hook.
11. Place the gusset strap onto the bottom of the frame, install the OE bolt into the rear hole in the bracket and the frame securing it into the OE flag nut inside the frame. **See Photo 10.**

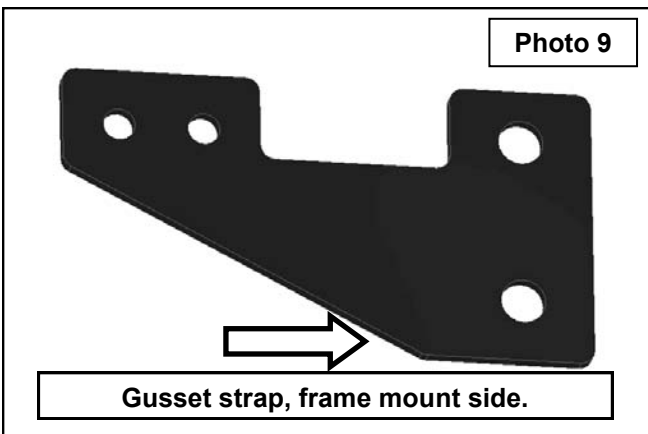

12. Install the tow hook and the remaining bolt. Hand tighten bolts at this time. **See Photo 11.**
13. Repeat steps 9 –12 on the opposite side of the vehicle. **See Photo 12.**

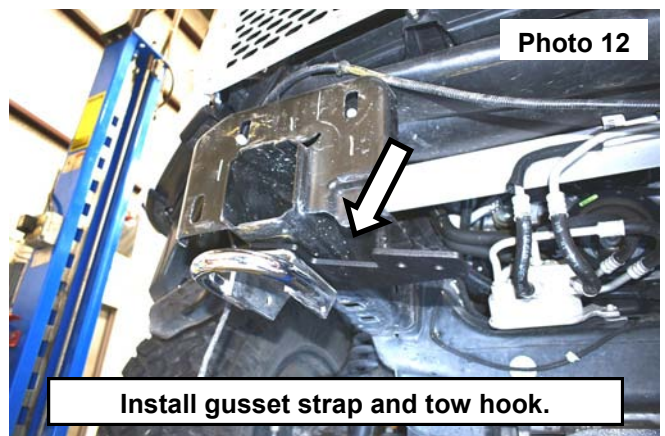
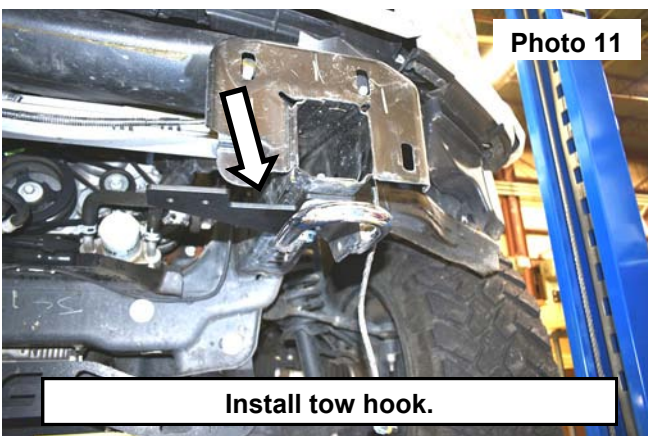

14. Install the winch control box and the ground wire, follow the instructions supplied with the winch.
15. Lay the winch on the ground, upside down, to Install the 4 supplied (with the winch) square nuts in the bottom of the winch. **See Photo 13.**
16. Place the winch plate onto the winch. **See Photo 14.**

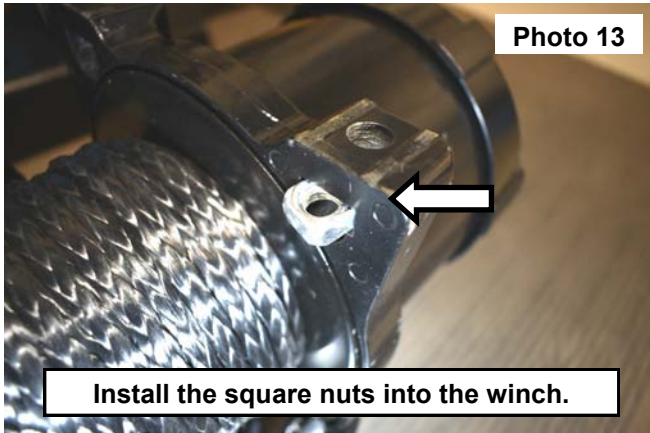

17. Install the supplied bolts, lock washers and washers into the winch plate and square nuts, in the winch. Tighten using a 16mm wrench. **See Photo 15.**
18. Pull the winch cable through the front of the fairlead mount. **See Photo 16.**

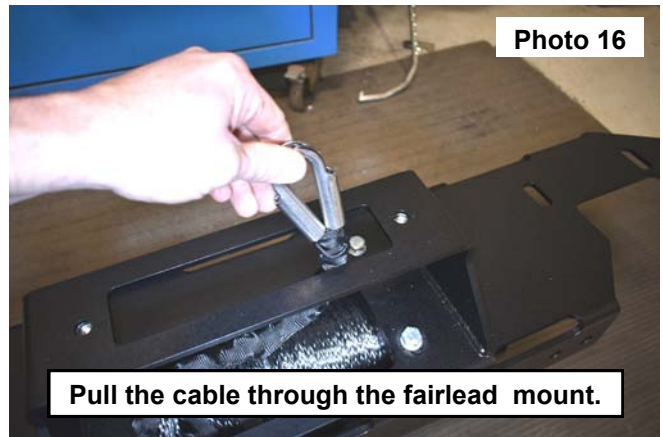

19. Install the winch and plate onto the bumper mount, install the bolt plate from the back side of the bumper mount. **See Photo 17.**
20. Install the (2) 1/2-13 x1.5" long bolts, (4) washers and (2) nylock nuts into the winch plate and the tow hook gusset strap. **See Photo 18.** Repeat this step on the opposite side of the winch plate.

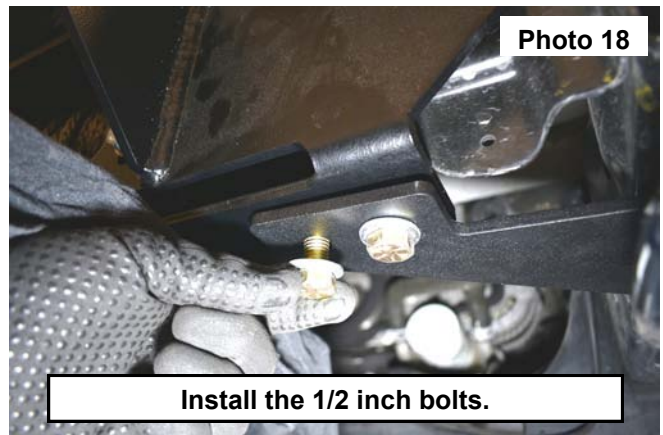
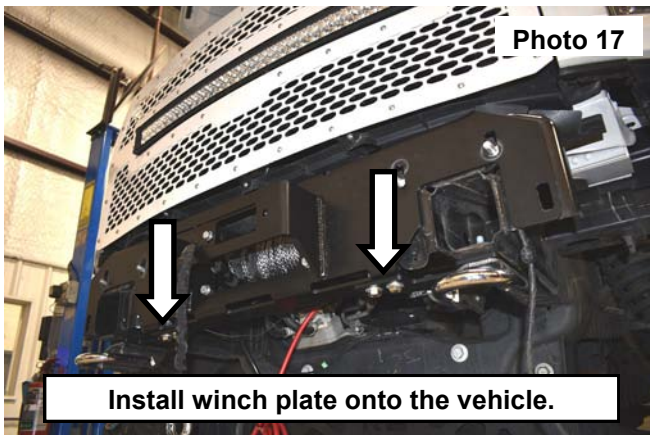

21. Make sure the winch plate is flush with the bumper mount and tighten the tow hook, Torque to 40 ft-lbs. using a 15mm socket. **See Photo 19.**
22. Tighten the gusset strap and the winch plate bolts, Torque to 90 ft-lbs. using a 19mm wrench and socket. **See Photo 20.**

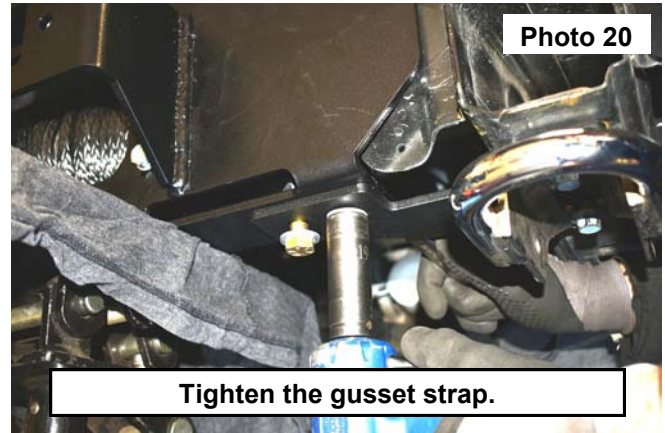
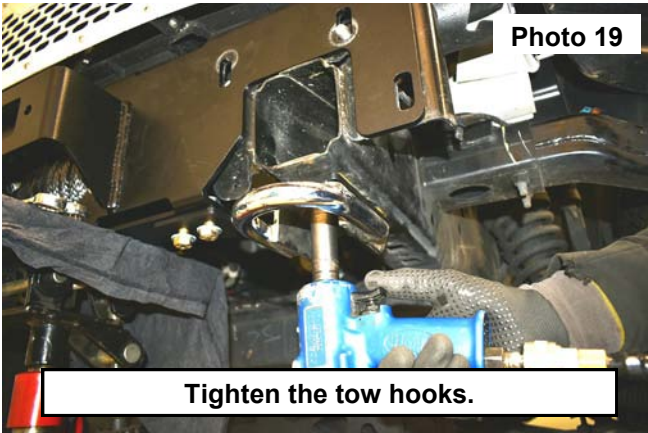

23. Use locking pliers to bend the top 2 tabs back for clearance of the fairlead mount. **See Photos 21 and 22.**

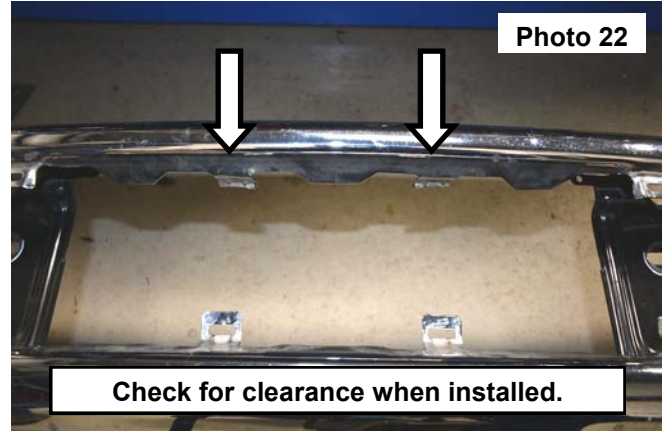
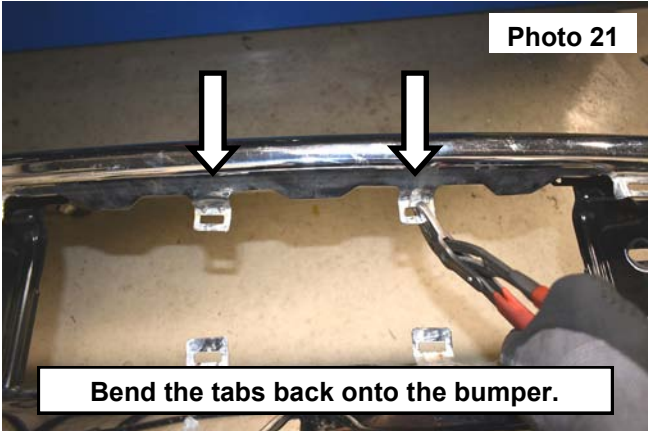

24. Install the bumper onto the vehicle, thread the 2 factory nuts onto the bolt plate on each side of the bumper. **See Photo 23.**
25. Align the nuts with the marks made on the bumper, snug the nuts making sure the gap is the same under the head lights on each side. **See Photo 24.**

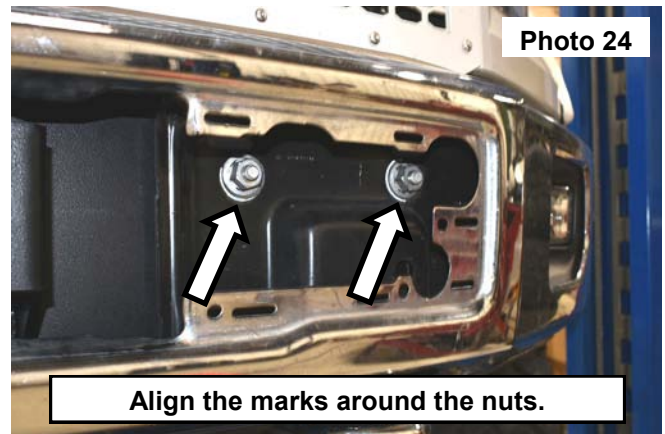

26. Once the bumper has been aligned, torque the nuts to 55 ft-lbs. using a 21mm socket. **See Photo 25.**
27. Install the nuts on the back side of the bumper, Torque to 55 ft-lbs. using a 21mm socket. **See Photo 26.**

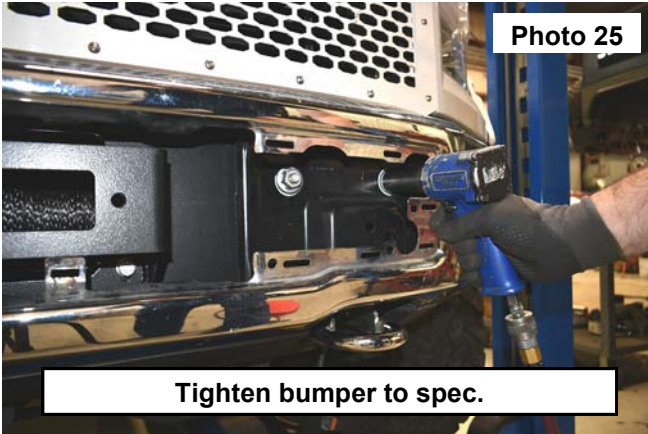

28. Connect the fog lights and wiring clips on each side of the bumper. **See Photo 27.**
29. Mark the back side of the bumper center cover, trim just to the inside of the clips and to the edge of the opening on each side. **See Photo 28.**

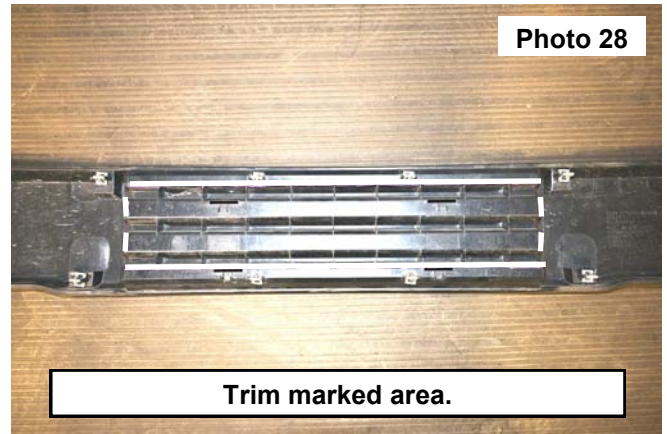
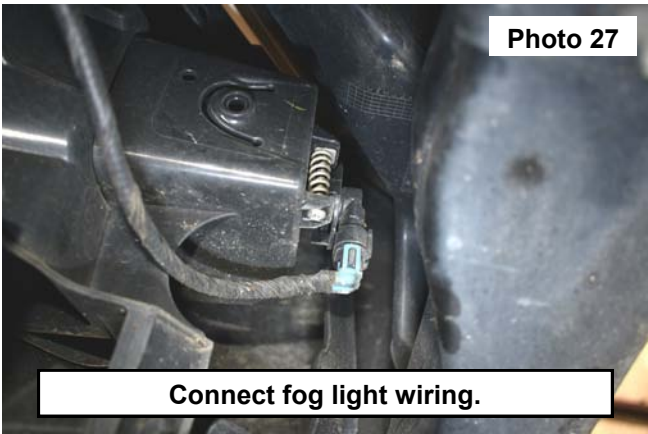

30. After trimming, smooth any rough edges with a sander or file. **See Photo 29.**

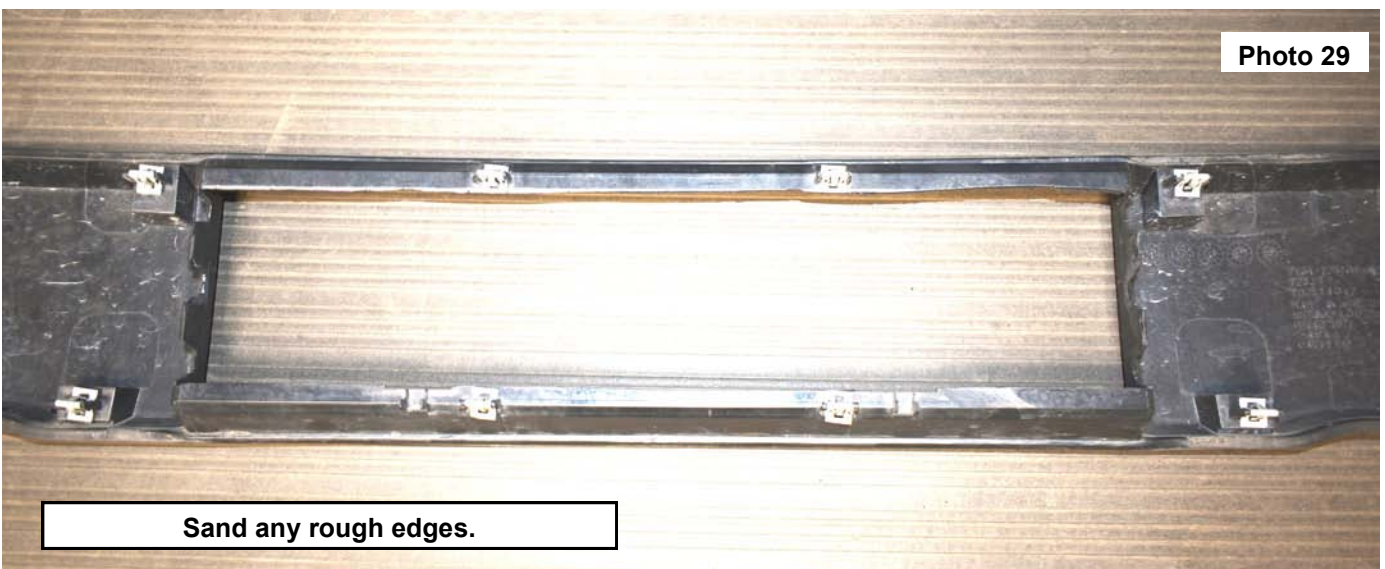

31. Install the center cover onto the bumper, press to seat all of the clips into the bumper. **See Photo 30.**
32. Check for clearance of the center cover and the fairlead mount. **See Photo 31.**

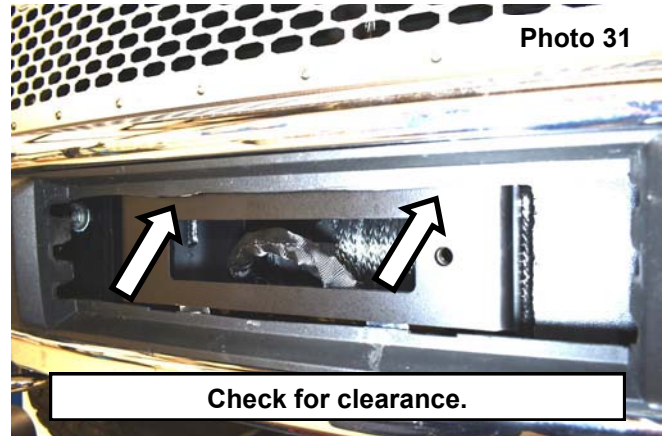

33. Locate the hidden winch cover and install the wire extension, using the supplied #8-32 x1.0 socket head bolts and nylock nuts. Tighten using a 9/64 allen and a 9mm wrench. **See Photo 32.**
34. Connect the extension cable into the winch, Install the hidden winch cover onto the bumper. **See Photo 33 and 34.**

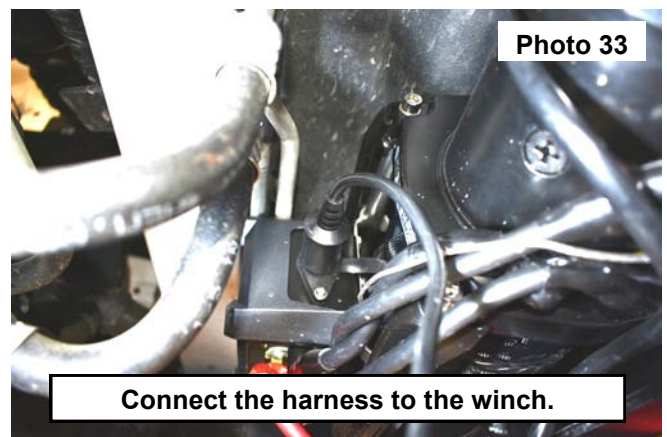

35. Install the supplied fairlead onto the cover. Using the supplied hardware in the winch kit. Tighten using an 18mm socket. **See Photo 35.**

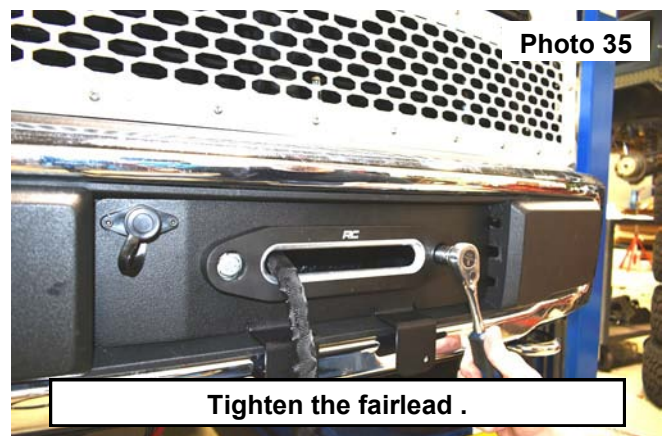

36. Connect the wiring to the battery terminals, secure any loose wiring.
37. Check all installed hardware to be tight.
38. Connect the hook to the tow hook and pull the cable snug. **See Photo 36.**
39. Remove the wheel chocks.

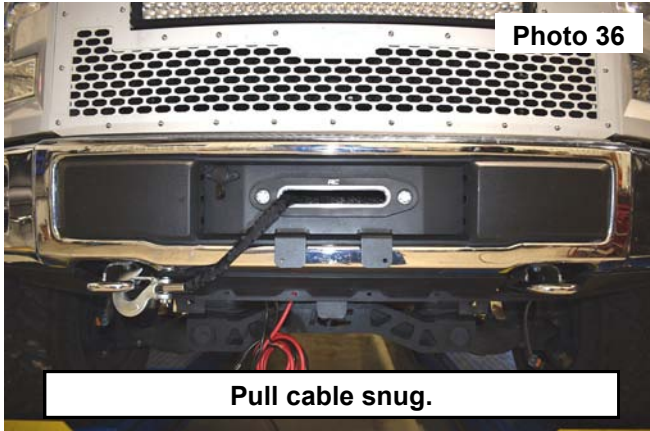

By purchasing any item sold by Rough Country, LLC, the buyer expressly warrants that he/she is in compliance with all applicable , State, and Local laws and regulations regarding the purchase, ownership, and use of the item. It shall be the buyers responsibility to comply with all Federal, State and Local laws governing the sales of any items listed, illustrated or sold. The buyer expressly agrees to indemnify and hold harmless Rough Country, LLC for all claims resulting directly or indirectly from the purchase, ownership, or use of the items.

