



RAM 2019 3500 Standard Duty 5" Radius Arm Kit

Thank you for choosing Rough Country for all your vehicle needs.

Please read instructions before beginning installation. Check the kit hardware against the kit contents shown below. Be sure you have all needed parts and know where they go. If question exist, please call us @1-800-222-7023. We will be happy to answer any questions concerning this product. Check all fasteners for proper torque. Check to ensure for adequate clearance between all components. Periodically check all hardware for tightness.

▲ NOTICE THIS KIT WILL ONLY FIT 3500 MODELS WITH: 6.7L HO TURBO DIESEL W/ 6-SPEED AISIN TRANSMISSION

▲ WARNING Product Use Information
As a general rule, the taller a vehicle is the easier it will roll. We strongly recommend, because of rollover possibility, that the vehicle be equipped with a functional roll-bar and cage system. Seat belts and should harnesses should be worn at all times. Avoid situations where a side rollover may occur.

Also check the steering stabilizer. It is a good idea when adding larger than stock tires to go with a larger bore steering stabilizer or a dual unit for tires 35" and above. Inspect the stabilizer and replace as necessary.

Braking performance and capability are decreased when significantly large/heavier tires and wheels are used. Take this into consideration while driving.

Do no add, alter, or fabricate any factory or after-market parts which increase vehicle height over the intended height of the Rough Country product purchased. Mixing component brands, lifts, and/or combining body lift with suspension lifts voids all warranties. Rough Country makes no claims regarding lifting devices and excludes any and all implied claims. We will not be responsible for any product that is altered.

This suspension system was developed for 37x12.50 tire on an aftermarket wheel with a minimum of 5" back spacing. When larger tires are installed, speedometer recalibration is necessary. Due to ride height inconsistencies from the factory you may need to slightly trim the front plastic valance for proper tire clearance.

▲ NOTICE On vehicles equipped with a two piece driveshaft & carrier bearing as on the Mega Cab, there is the potential for take off vibration, depending on the severity this can be corrected with shimming down the carrier bearing with the included shims and hardware.

▲ NOTICE Notice to Dealer and Vehicle Owner

Any vehicle equipped with any Rough country product must have the "Warning to Driver" decal installed on the sun visor or dash. The decal is to act as a constant reminder for whoever is operating the vehicle of its unique handling characteristics. **INSTALLING DEALER—It is your responsibility to install the warning decal and to forward these installation instructions to the vehicle owner for review and to be kept in the vehicle for its service life.**

Torque Specs:

Size	Grade 5	Grade 8	Size	Class 8.8	Class 10.9
5/16"	15 ft/lbs	20ft/lbs	6MM	5ft/lbs	9ft/lbs
3/8"	30 ft/lbs	35ft/lbs	8MM	18ft/lbs	23ft/lbs
7/16"	45 ft/lbs	60ft/lbs	10MM	32ft/lbs	45ft/lbs
1/2"	65 ft/lbs	90ft/lbs	12MM	55ft/lbs	75ft/lbs
9/16"	95 ft/lbs	130ft/lbs	14MM	85ft/lbs	120ft/lbs
5/8"	135ft/lbs	175ft/lbs	16MM	130ft/lbs	165ft/lbs
3/4"	185ft/lbs	280ft/lbs	18MM	170ft/lbs	240ft/lbs



BOX KIT

37830

1368BOX1
1368BOX2
37830BOX1
37530BOX2
9299
37830BOX3

1368BOX1:

Driver Side Radius Arm x1

1368BOX2:

Pass Side Radius Arm x1

37530BOX1:

378INSTBAG2 x1
37530BAG x1
36030BAG3 x1
Pitman Arm x1
Front Track Bar x1
Carrier Bearing Shims x3
3" Rear Blocks x2
9/16" x 4-1/8" x 13-1/2" U-Bolts x4
9/16" x 4-1/8" x 15-1/4" U-Bolts x4
Bump Stop x2
Rear Brake Line Bracket x1
E-Brake Bracket x1
E-Brake Bracket EXT x1
Front Brake Line Bracket x1
Drivers Side Sway Bar Bracket x2
Pass Side Sway Bar Bracket x2

37530BOX2: 5" Kit with N3 Shocks

Front 660783 x2
Rear 660744 x2

9299:

5" Coil Springs x2

37830BOX3:

T-Case Seal Adapter x1
Transmission Crossmember x1
Transfer case Wire Loom Bracket x1
Transfer case Clocking Ring x1
37830BAG1 x1
37830BAG2 x1

TOOLS NEEDED:

10mm Wrench or Socket
13mm Wrench or Socket
15mm Wrench or Socket
21mm Wrench and Socket
24mm Wrench and Socket
27mm Wrench and Socket
5/8 Wrench and Socket
9/16 Wrench and Socket
7/16 Wrench and Socket
E9 Torx Socket
6mm Allen Wrench
Torque Wrench
Snap Ring Pliers
Pit Man Arm Puller
Jack
Jack Stands
Transmission support stand
Transmission jack for the-
Transfer Case.

KIT BAGS

378INSTBAG2:

Instruction Sheet Bag

36030BAG3: Front Kit Bag

7/16" Flat Washer x8
5/16-18 Nylock Nut x2
5/16-18 x 3/4 Hex Head Bolt x2
7/16-14 x 1-1/4 Hex Head Bolt x4
7/16-14 Nylock Nut x4
5/16" Flat Washer x2
14mm-2.0 Nylock Nut x2
9/16" Flat Washer x2

9/16BAG: For Rear U-bolts

9/16" Flat Washers x8
9/16-18 Nylock Nut x8

1161BAG: For Carrier Bearing Shims

10mm-1.5 x 55mm Hex Head Bolts x2
3/8" Flat Washer x4

37830BAG1: For Transfer case Clocking Ring

14mm-2.0 x 200mm Hex head Bolt x2
14mm-2.0mm Nylock Nut x2
3/8-16 x 1.25 Hex Head Bolt x2
3/8" Flat Washer x2
10mm-1.25 Flange Nut x8
10mm-1.25 x 40mm Press In Stud x8
10mm-1.5 x 30mm Flat Head Bolt x8
10mm-1.25 Nut x1
1/2-20 Jam Nut x1
1/4" Flat Washer x2
1/4-20 Nylock Nut x1
1/4-20 x 1 Hex Head Bolt x1
9/16" Flat Washer x4

37830BAG2: For Transfer case Clocking Ring

Transmission Rear Output Seal x1
Transmission R/O Seal Adapter O-Ring x1



37830

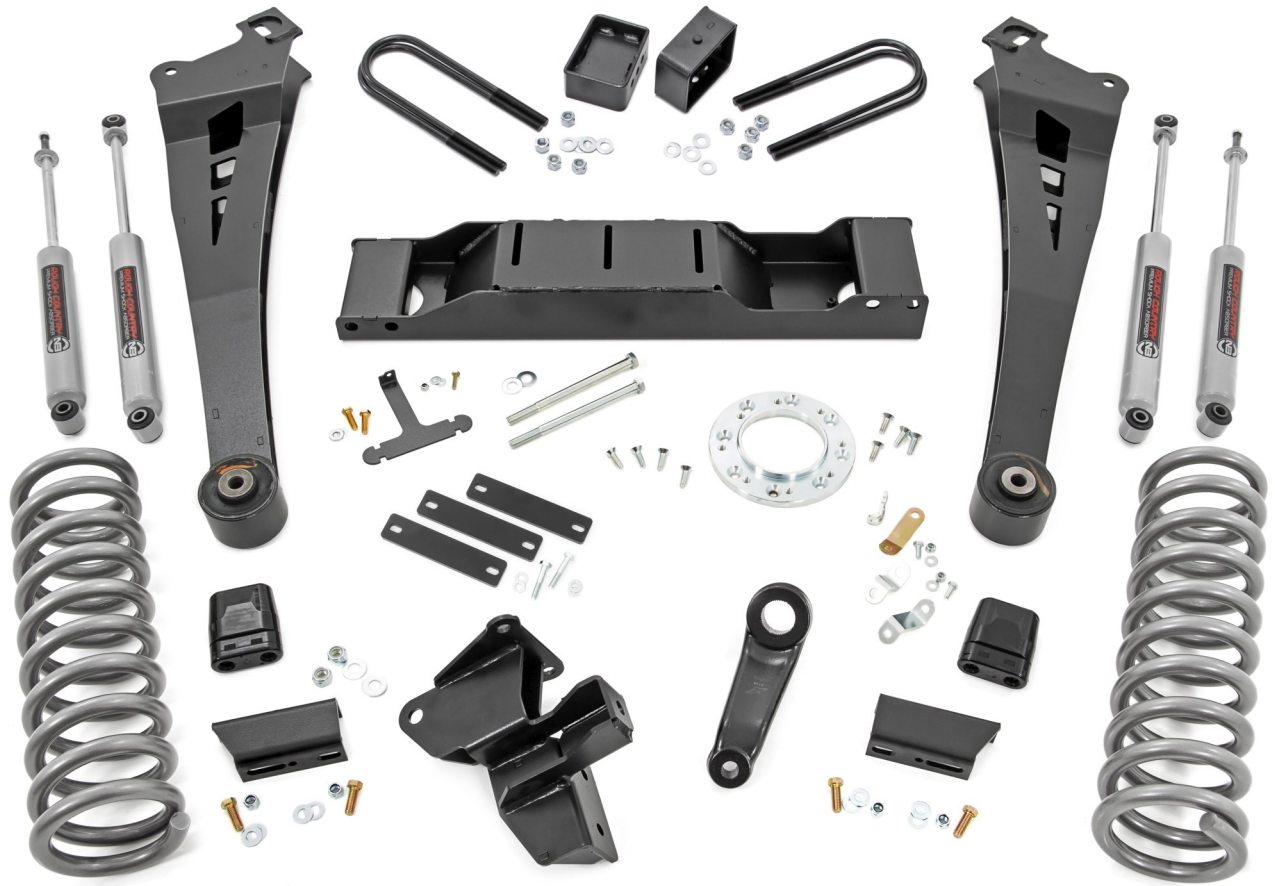

FRONT SUSPENSION INSTALLATION

1. Secure and block the rear tires of the vehicle on a level concrete or asphalt surface
2. Raise the front of the vehicle and support the frame with jack stands. Remove the front wheels and tires and set aside. Position a hydraulic jack under the front axle and raise the jack until the front suspension begins to compress.
3. On both sides of the vehicle, scribe alignment marks on the adjustment cam and axle bracket at the lower axle bolt of the radius arm for later reference.
4. Unbolt the brake line brackets from the inside of the frame using a 13mm wrench to ensure brake line free play during the suspension system installation. **See Photo 1.** Retain stock hardware for later use.
5. Unplug the electrical connector for the four wheel drive engagement. **See Photo 2.**
6. Using a 15mm wrench, remove the bolts from the front driveshaft at the pinion flange. Retain hardware. **Do not allow the driveshaft to hang by the Rzeppa joint, this can cause damage to the joint. Place a jack under the driveshaft or use wire to tie it up.**
7. Remove the sway bar links by unbolting the lower sway bar nut as shown in **Photo 3** using a 10mm socket and a

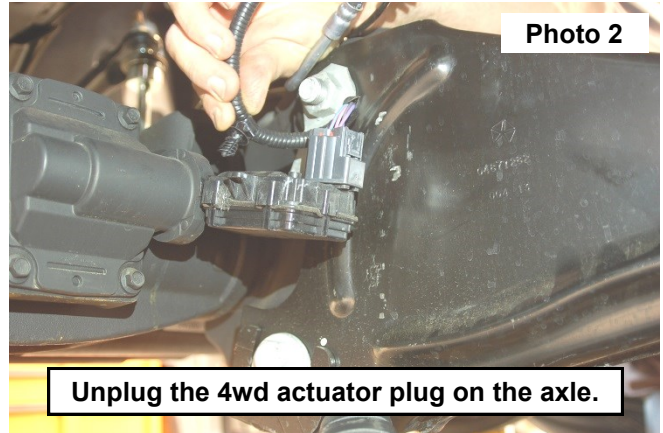
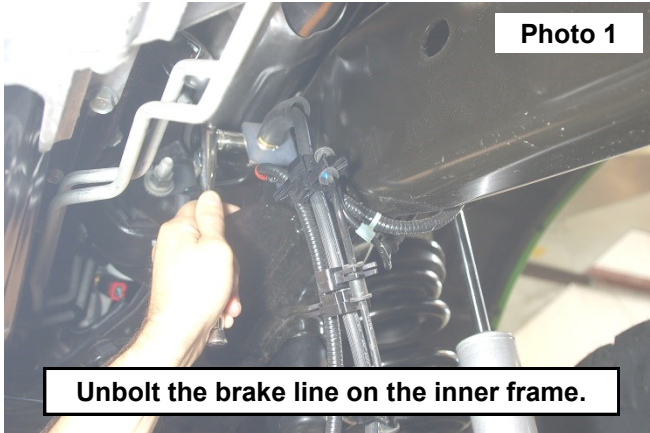

21mm wrench. Retain hardware.

8. Remove the track bar from its upper mounting point on the frame using a 1-1/16" wrench and rest it on the axle. It may be helpful to loosen the lower track bar bolt on the axle. Retain hardware for reuse.
9. Remove the cotter pin, and castle nut from the drag link where it connects to the pitman arm. A pitman arm tool may be needed to separate the drag link from the pitman arm. Remove the stock nut, and lock washer from the sector shaft on the steering box. Save hardware for later installation. Using a pitman arm puller carefully remove the stock pitman arm.
10. Remove the front shocks with a 18mm wrench for the upper stud and a 21mm socket for the lower bolt. **See Photo 4.** Retain lower shock mount factory hardware.
11. Lower the axle and remove the coil springs. Note there is a rubber push pin made on to the factory coil isolator to align the coil spring. Push on the top the pin to release the isolator from the frame coil pocket.

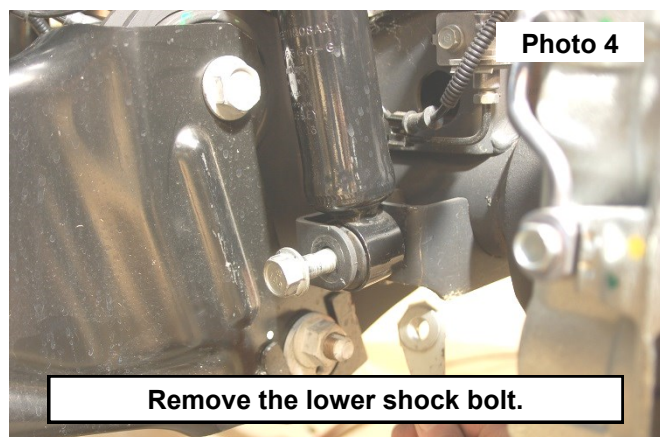
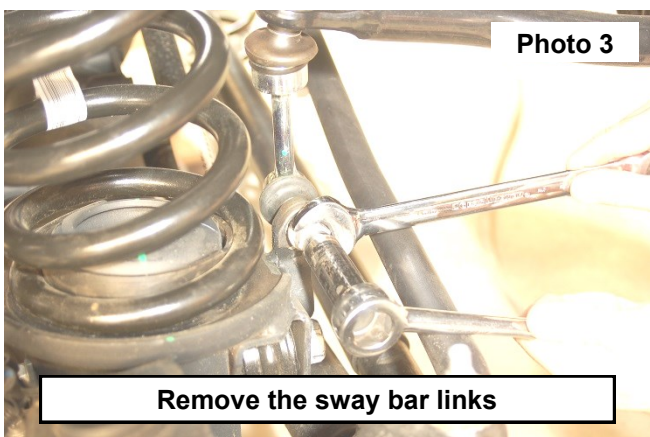

12. Using a 24mm socket and wrench remove the two bolts holding the driver radius arm to the axle. Retain factory hardware.
13. Next remove the radius arm bushing bolt with a 27mm socket and wrench. Retain factory hardware.
14. Install the supplied driver side radius arm with factory hardware. **See Photo 5.** Note the offset side of the radius arm goes to the outside of the truck. Do not tighten the radius arm bushing bolt until the truck is sitting on the ground.
15. Repeat steps 12-14 on the passenger side.
16. Use the supplied template to rotate the spring isolator **on the pass side only.**
17. Install the supplied lifted coil springs, making sure the coil is properly seated in the upper and lower coil seats.
18. Install the new front shocks, (660783), using the supplied bushings for the top mount. Using an 18mm, torque to 30 ft-lbs. or just until the bushings start to bulge under the washers.
19. Install the shock in the lower mount using the factory hardware. Torque to 88ft-lbs using a 21mm socket. **See Photo 6.**

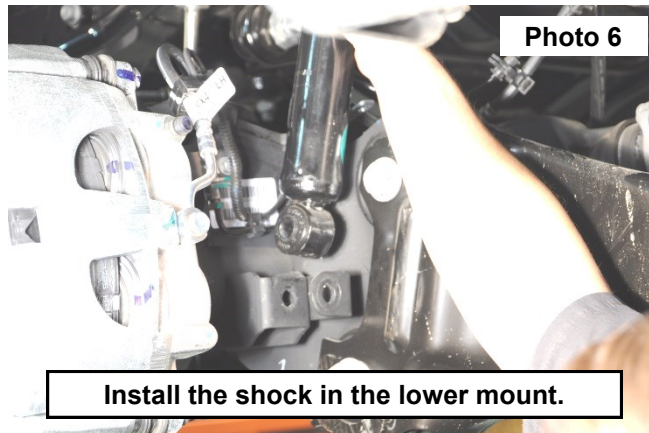
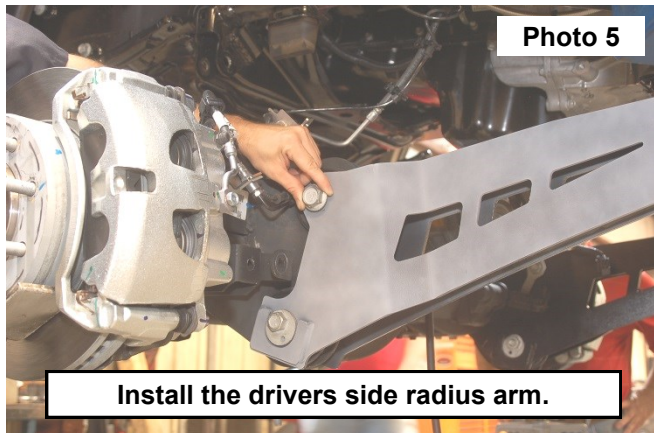

20. Remove the factory bump stop and replace it with the new supplied longer poly bump stop. **See Photo 7.**
21. Install the supplied (6625) pitman arm onto the stock sector shaft using the factory hardware, apply thread locker and torque to 400 ft-lbs.
22. Using a 21mm socket, remove the 5 bolts securing the factory track bar bracket to the frame. Retain hardware. **See Photo 8.**

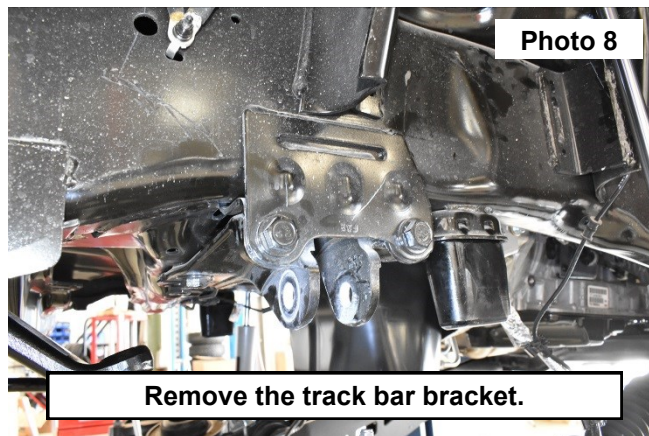

23. Install the supplied track bar bracket to the factory mount using the factory bolts. The (2) horizontal factory mounting bolts will use (2) supplied 14mm nylock nuts and washers (36030BAG3). Torque to 120ft-lbs using a 21mm socket and wrench. **See Photo 9.**
24. **The track rod will be installed into the new mount after the vehicle is on the ground.**
25. Remove the sway bar hardware using an 18mm wrench as shown in **Photo 10** and allow the sway bar to separate from the frame.

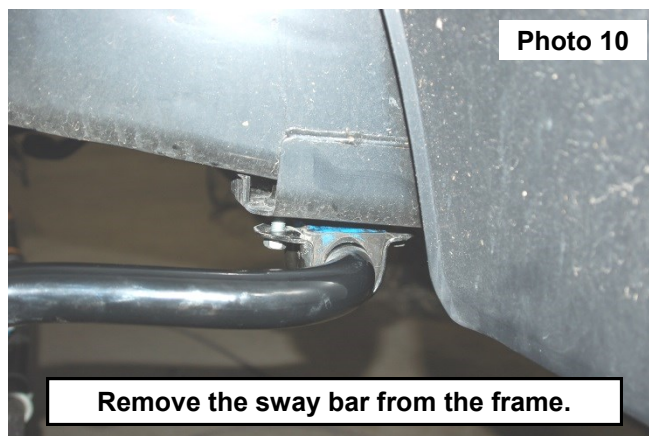
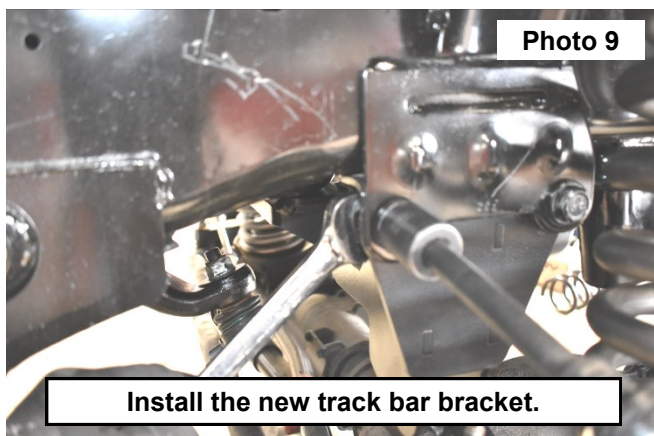

26. Install the sway bar drop bracket and secure to the frame using the factory hardware. Using an 18mm socket, Torque to 55ft-lbs.
27. Install the sway bar to the new bracket with the supplied 7/16" x 1 1/4" bolts, flat washers and nuts (36030BAG3). **See Photo 11.** Torque to 60ft/lbs using a 5/8" socket and wrench.
28. Install the front **Driver Side (2 Bends)** brake line bracket to the frame using factory hardware, Torque to 15ft-lbs. **See Photo 12.** Attach the brake line mount to the new bracket with the supplied 5/16" x 3/4" bolts, washer, and nuts (36030BAG3). Torque to 15ft-lbs with a 13mm socket and wrench.

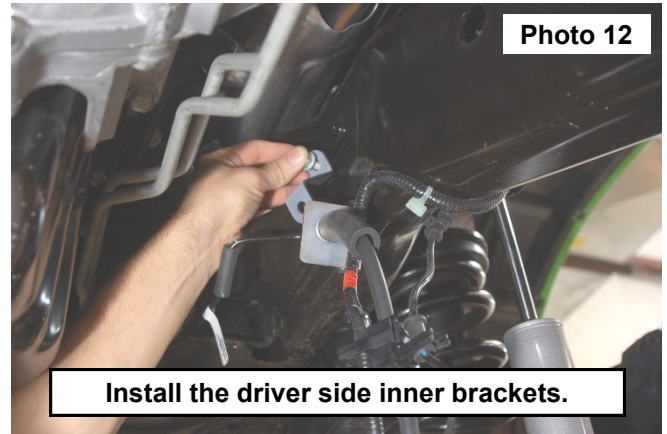
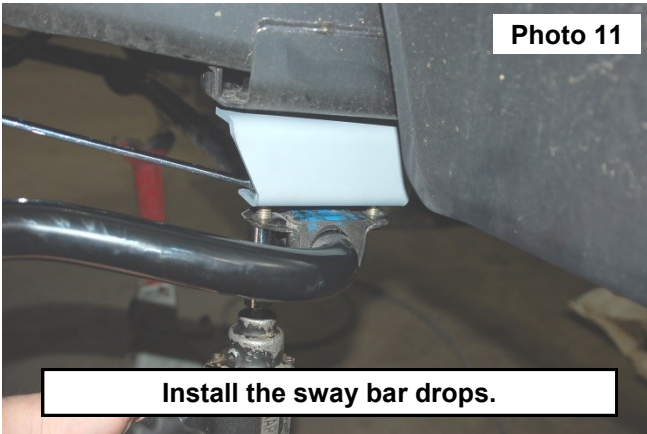

29. Attach the brake line mount to the new bracket with the supplied 5/16" x 3/4" bolts, washer, and nuts (36030BAG3). Torque to 15ft-lbs with a 13mm socket and wrench. Install the front **Passenger Side (1 Bend)** brake line bracket with bend at bottom away from frame, use factory hardware, Torque to 15ft-lbs. **See Photo 13.**
30. Using a 15mm wrench, remove the rear driveshaft from the rear pinion flange. Retain hardware. **See Photo 14.**

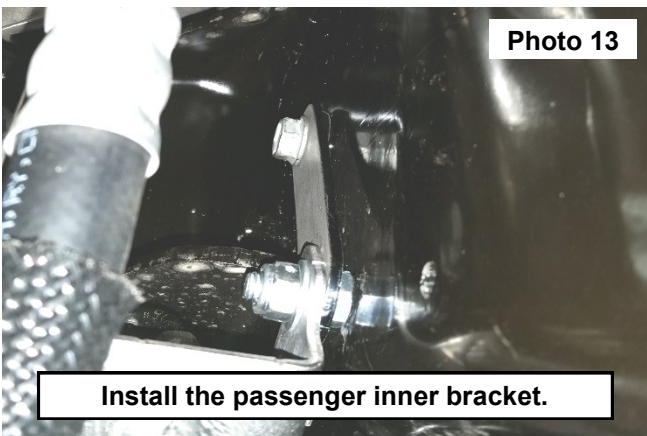

31. Using a pry tool, remove the wiring clips from the transfer case housing. **See Photo 15.**
32. Unplug all wiring harnesses from the transfer case. **See Photo 16.**

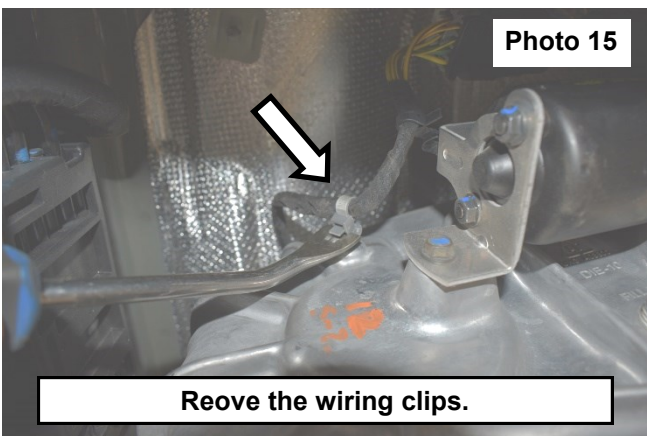

33. Using a jack stand, support the transmission. **See Photo 17.**
 34. Using a 13mm socket, remove the (3) nuts from the bottom of the transfer case crossmember. Retain hardware. **See Photo 18.**

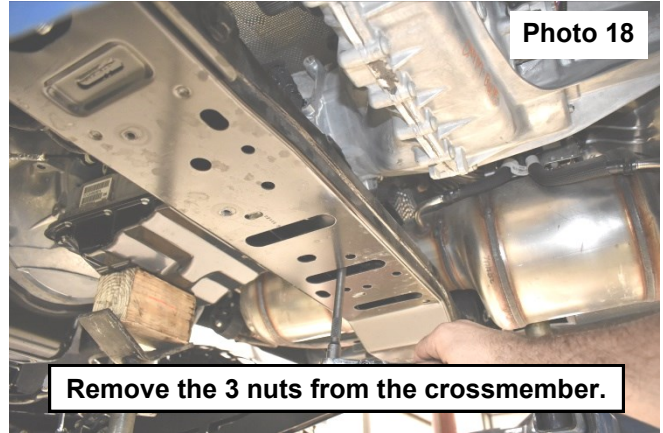
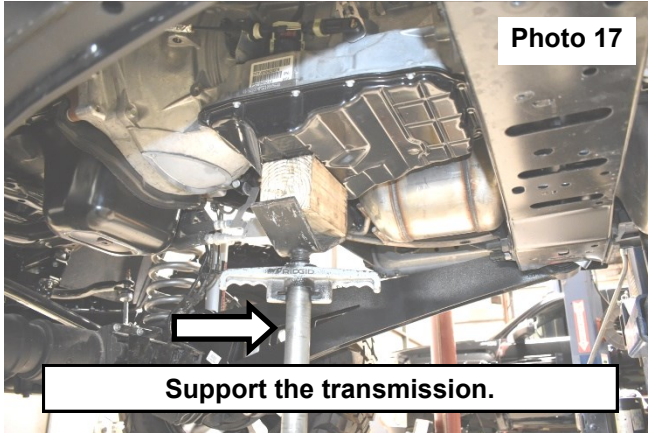

35. Using 24mm wrenches, remove the transfer case crossmember hardware. The passenger side bolts will have to be cutoff using a reciprocating saw. **See Photos 19 & 20.**

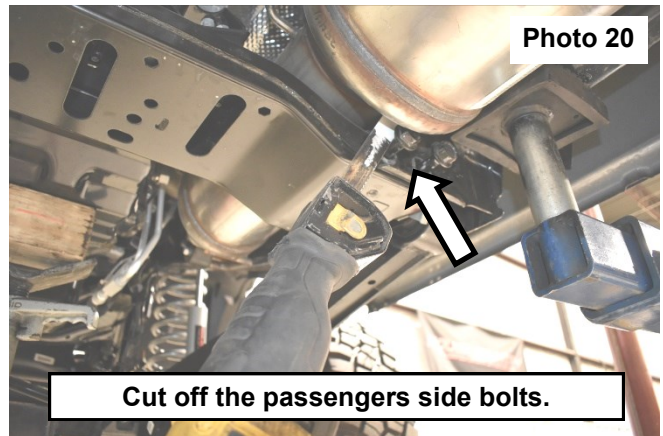

36. Using a pair of pliers release the front clamp on the front driveshaft dust boot, at the transfer case. **See Photo 21.**
 37. Roll the dust boot towards the transfer case.
 38. Using snap ring pliers, spread the snap ring and slide the driveshaft towards the front of the truck. **See Photo 22.**
 39. Remove the front driveshaft and set aside.

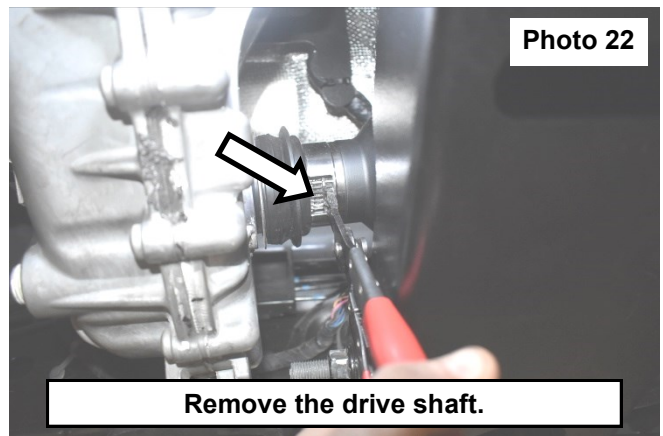
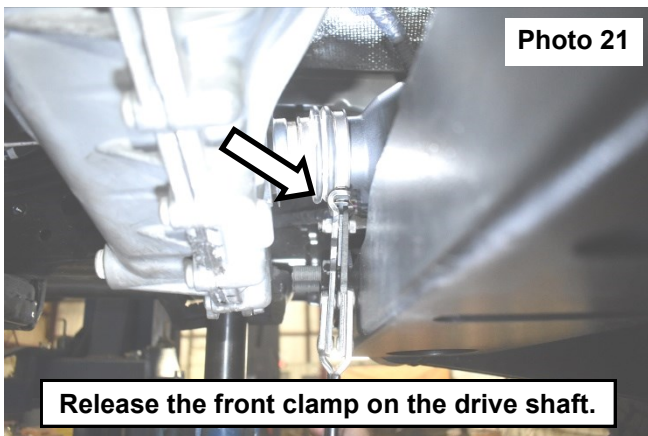

40. Using a 15mm wrench, remove the (3) rear bolts from the transfer case crossmember mount. Retain hardware. **See Photo 23.**
41. Using a 15mm socket, remove the (2) front transfer case crossmember mount bolts and remove the mount. Retain hardware. **See Photo 24.**

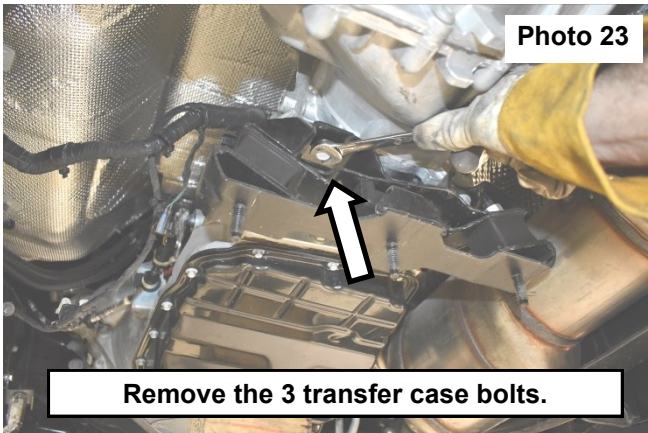

42. Place a jack/transmission jack under the transfer case.
43. Using a 15mm wrench and 15mm socket, remove the nuts from the transfer case mounting studs. Retain for reuse. **See Photo 25.**
44. Carefully remove the transfer case from the truck.
45. Using an E9 torx, remove the (8) transfer case studs from the transfer case. **See Photo 26.**

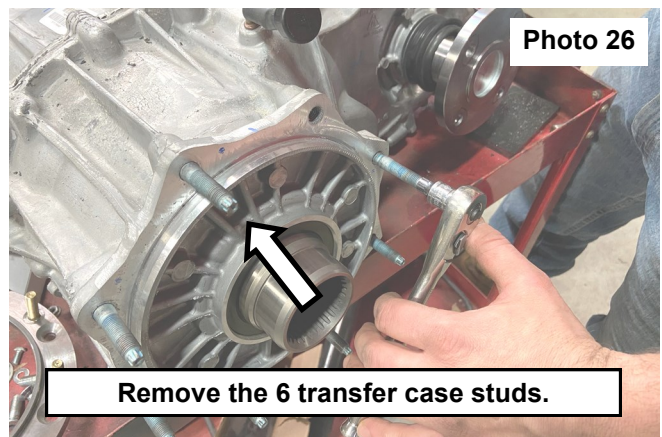
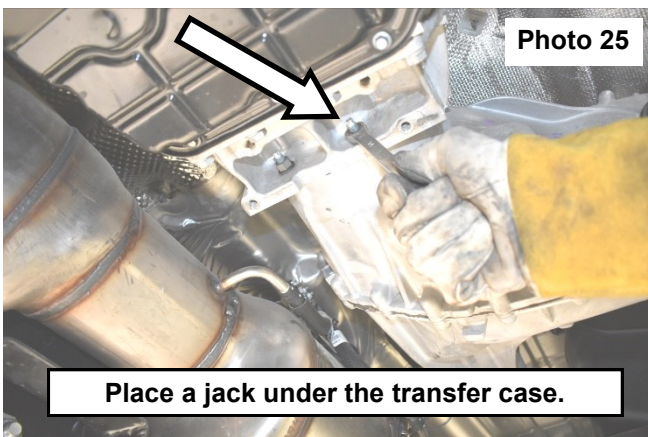

46. Install the (8) press in studs into the clocking ring. Seat them using the supplied 1/2" Jam nut and the standard 10mm nut. Use a 17mm wrench to tighten and seat the stud. **See Photo 27.**
47. Install the supplied clocking ring on the transfer case. Use (8) of the supplied 10mm x 30mm flat head bolts (37830BAG1). Apply a thread locker to the bolts and torque to 45ft/lbs using a 6mm Allen. **See Photo 28 and 29.**

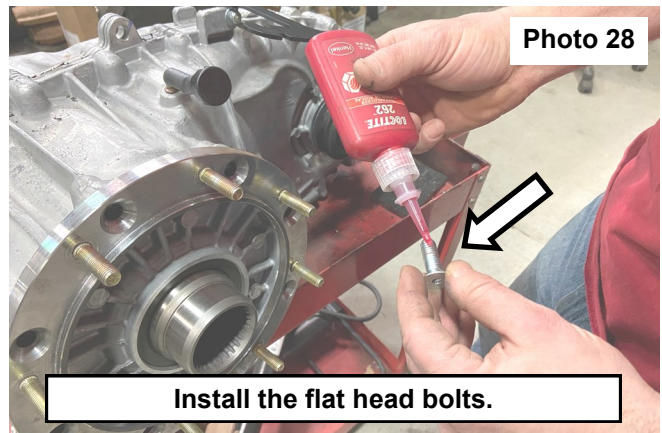
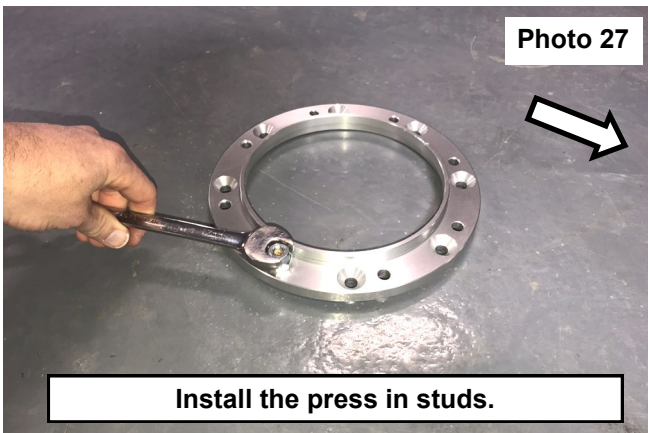

48. Install the o-ring into the groove in the transmission rear output seal adapter. **See Photo 30.**

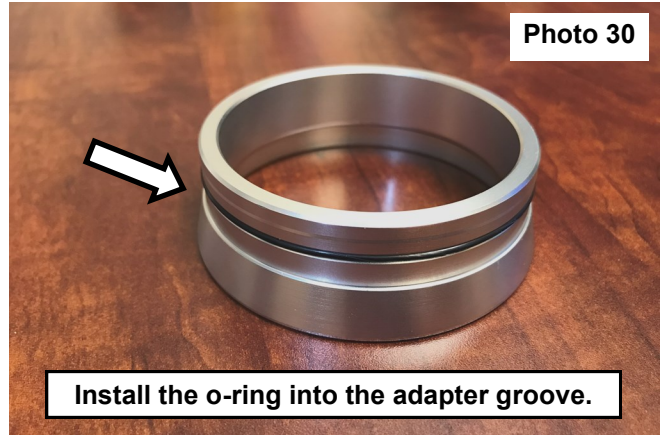
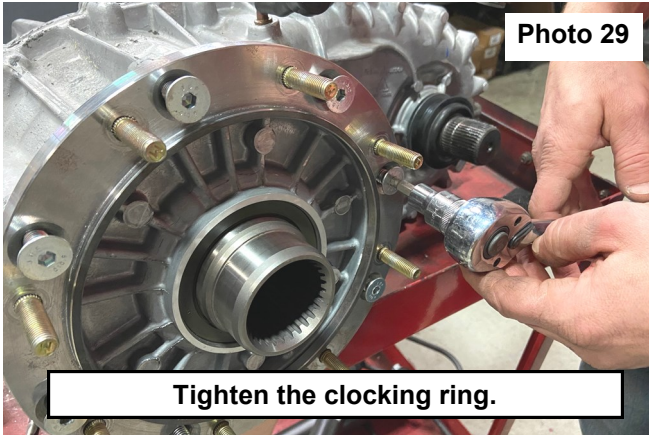

49. Using a seal puller or flat pry tool, carefully remove the transmission rear output shaft seal. **Take care not to damage the seal seat in the transmission. See Photo 31.**

50. Install the transmission rear output seal adapter into the transmission. **See Photo 32.**

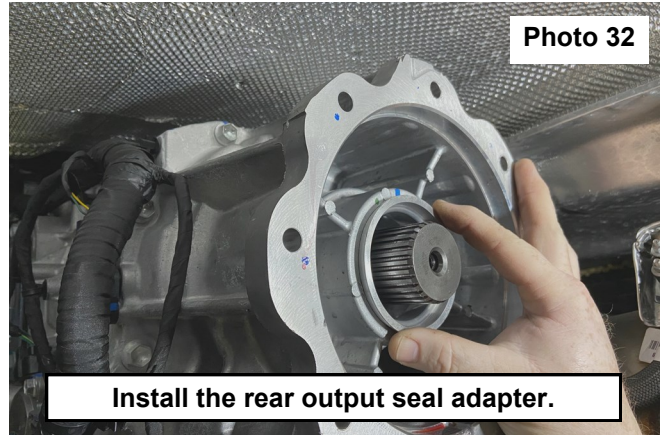
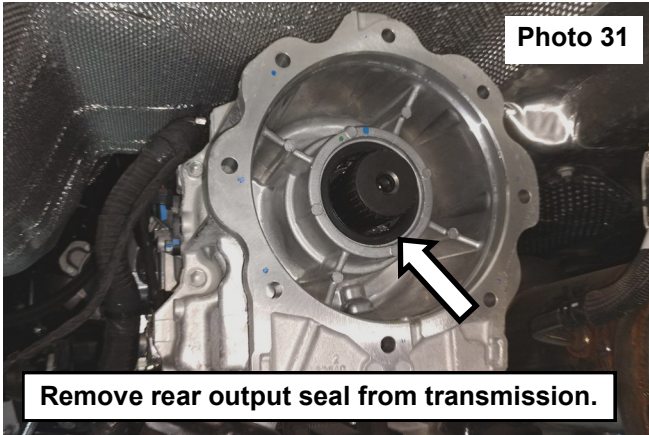

51. Install the seal in to the adapter. Lightly tap the seal into the adapter using a rubber mallet. **See Photo 33.**

52. Install the transfer case using the (8) supplied 10mm flange nuts (37830BAG1). Tighten using a 15mm wrench. **See Photo 34.**

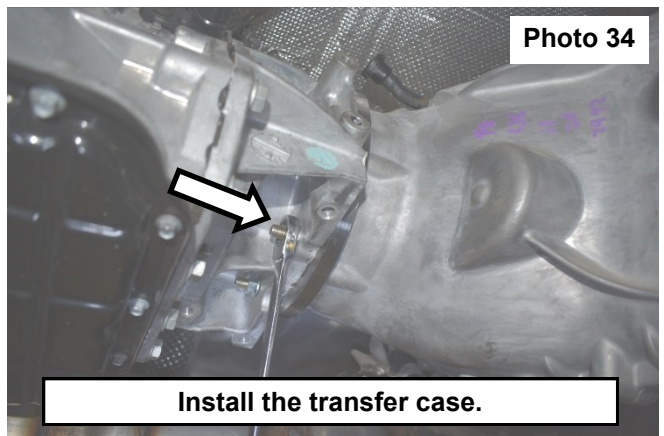

40. Install the transfer case crossmember mount using the factory hardware. Torque to 45ft/lbs using a 15mm socket. See Photos 35 & 36.

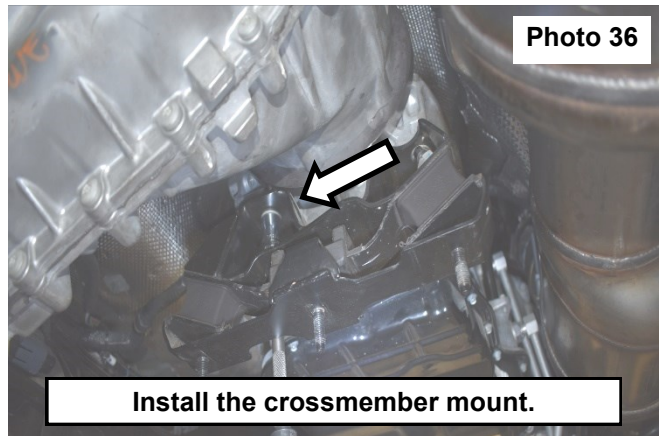
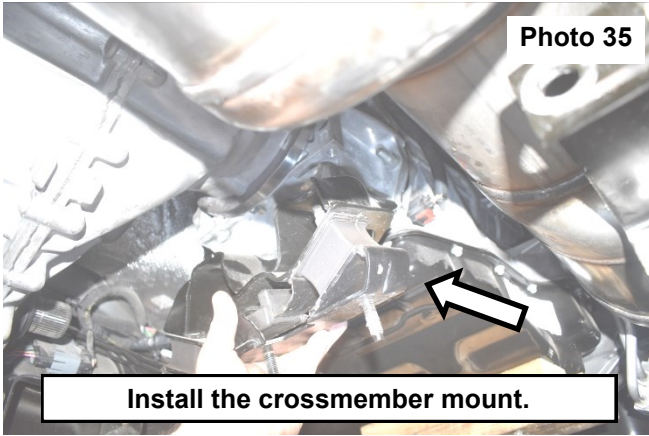

41. Install the supplied transfer case crossmember using the supplied 14mm x 200mm bolts, washers, and nylock nuts (37830BAG1) on the passenger side and the factory hardware on the driver side. See Photos 37 & 38.

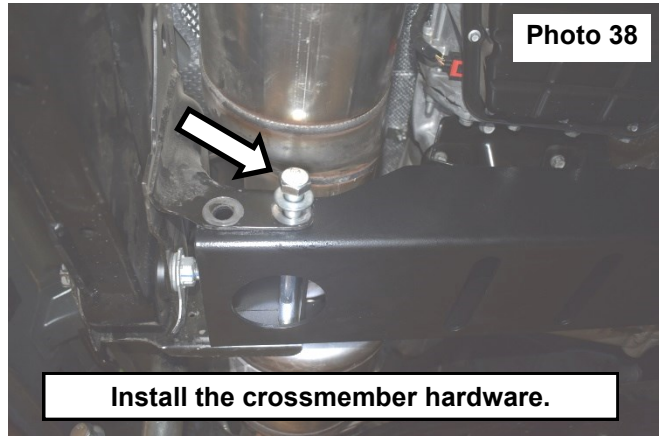
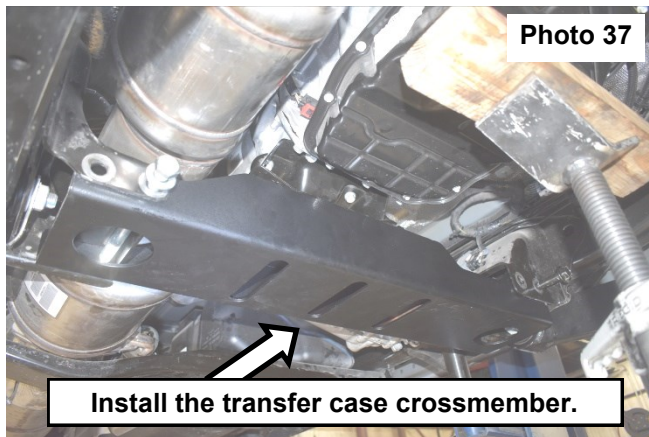

42. Torque to 120ft/lbs using 24mm socket and wrench. See Photo 39.
43. Attach the crossmember to the crossmember mount using the factory hardware. Torque to 45ft/lbs using a 15mm socket. See Photo 40.

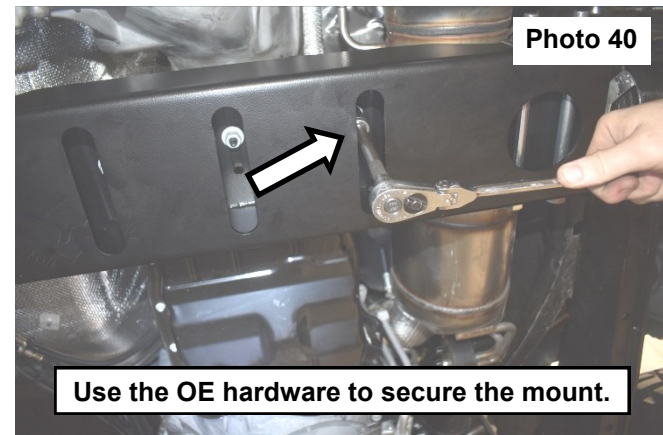
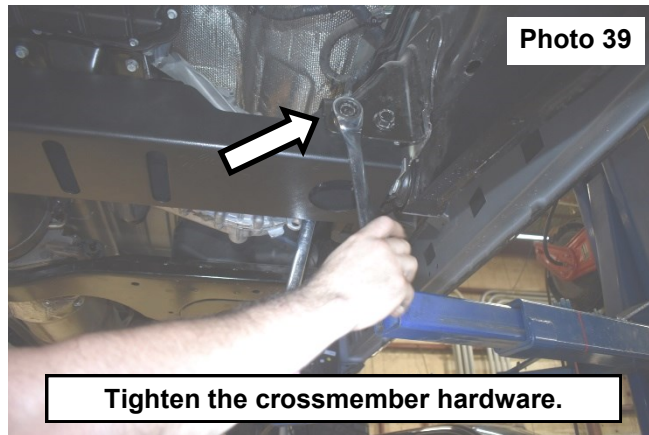

44. Attach the supplied wire loom bracket to the transfer case using the supplied 1/4" x 1" bolt, washers, and nylock nut (37830BAG1). Torque to 10ft/lbs using a 7/16" socket and wrench. **See Photo 41.**
45. Attach the transfer case wiring harness to the wire loom bracket using the supplied cable ties. **See Photo 42.**

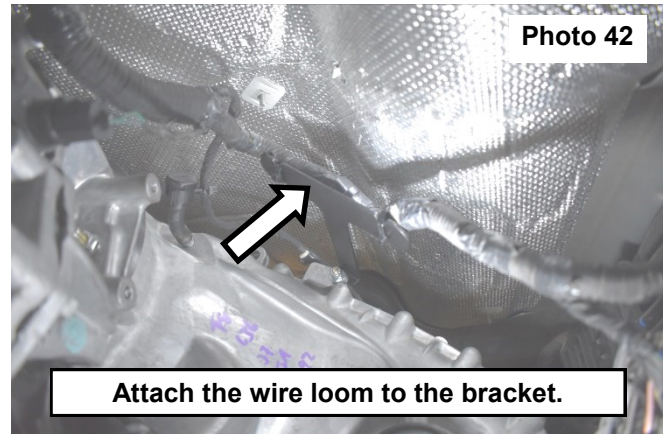
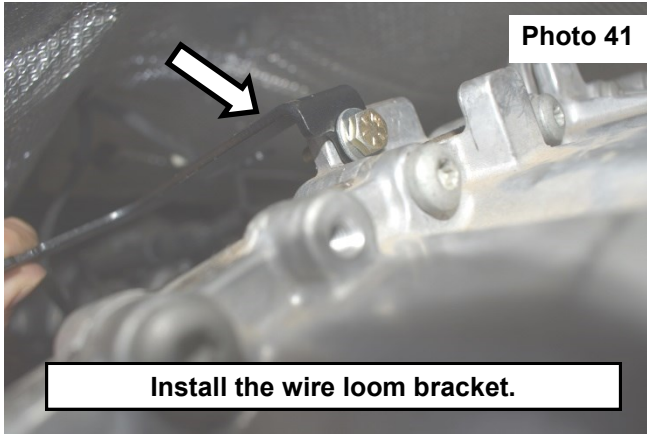

46. Install the front driveshaft on the transfer case.
47. Using snap ring pliers, slide the snap ring to the rear locking it into position. **See Photo 43.**
48. Roll the boot towards the front of the truck and install the front clamp. **See Photo 44.**
49. Attach the front driveshaft to the pinion flange using the factory hardware. Torque to 45ft/lbs using a 15mm socket.

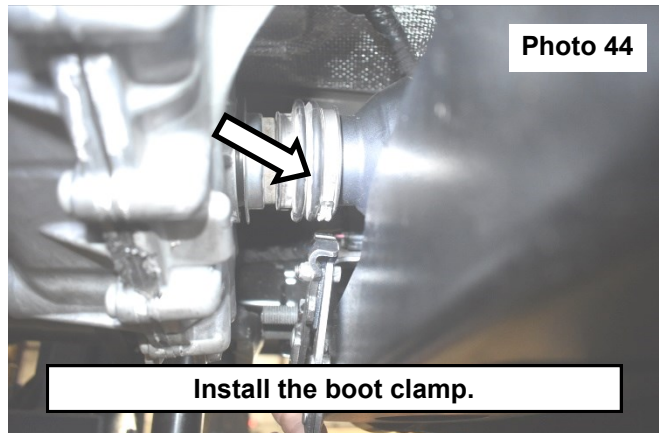
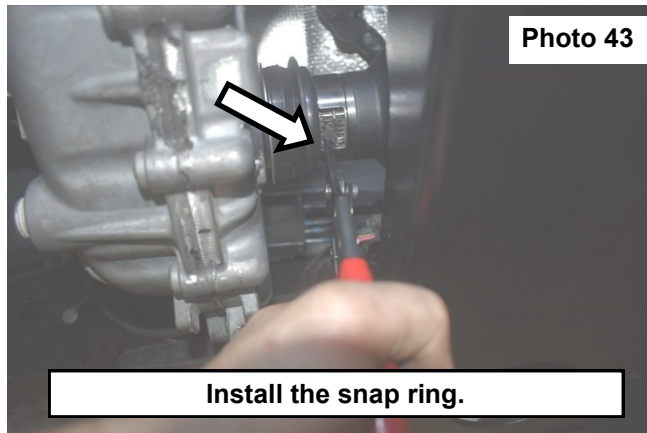

50. Install the rear driveshaft using the factory hardware. Torque the rear pinion flange bolts to 45ft/lbs using a 15mm socket. **See Photo 45.**
51. Install the tires / wheels and then lower the truck to the ground.
52. Install the track rod in the new bracket using the factory hardware. Torque to 170ft/lbs using a 1-1/16" socket and wrench.
53. Torque the radius arm bolt, to 270 ft-lbs, with a 1-1/16" socket.

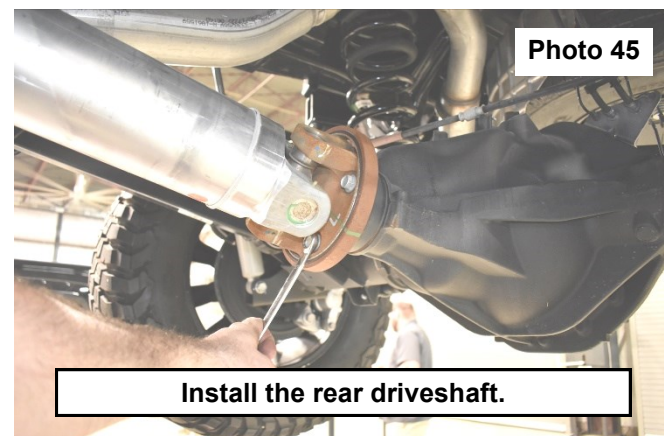

REAR INSTALLATION

1. Secure and block the front tires of the vehicle on a level concrete or asphalt surface.
2. Raise the rear of the vehicle and support the frame with jack stands. Remove the rear wheels and tires and set aside. Position a hydraulic jack under the axle and raise the jack until the suspension begins to compress.
3. Remove the upper and lower shock bolts using a 21mm socket. Remove shock and retain hardware for reuse. **See Photos 1 and 2.**

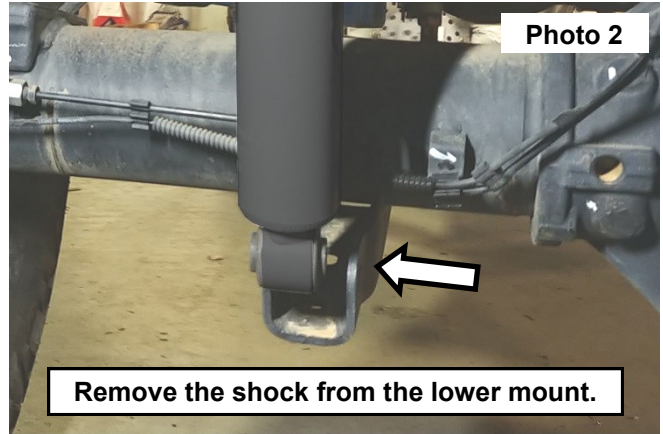
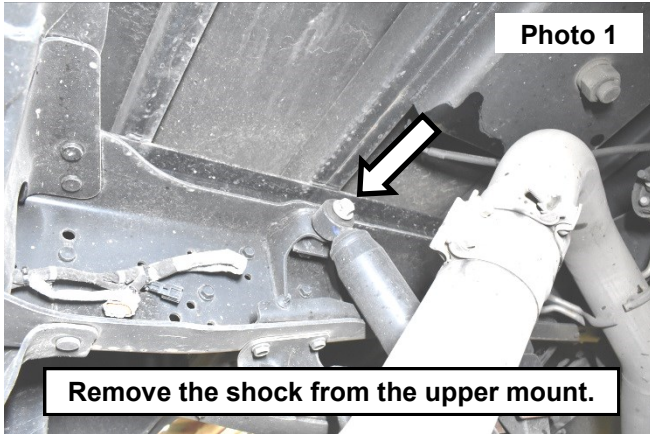

4. Remove the U-Bolts using a 21mm socket and lower the axle. **See Photo 3.**
5. Install the supplied block onto the axle. Then raise the axle up aligning the pins into the holes. **See Photo 4. NOTE: Install the block with the arrow pointing to the front of the vehicle.**

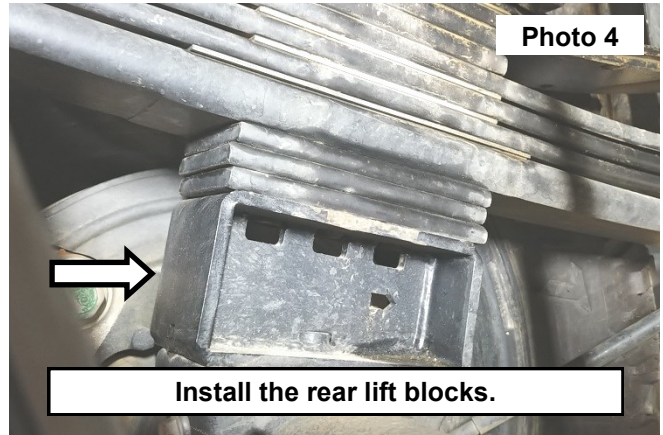
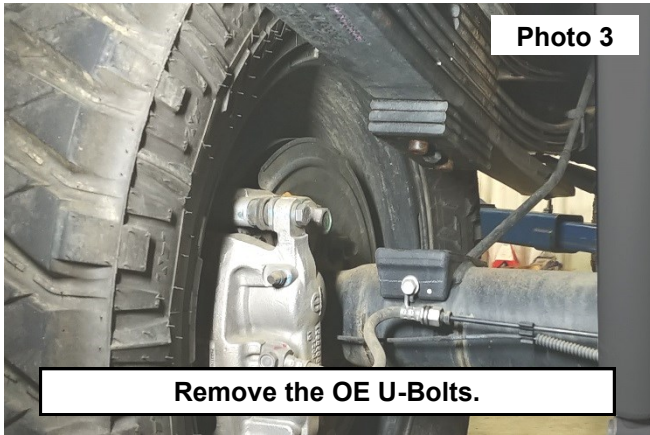

6. Install the supplied U-bolts around the axle and into the OE top plate secure using the supplied 9/16BAG. Tighten using a 22mm socket. **See Photo 5.**
7. Install the rear shocks (660744) into the upper and lower mounts and secure using the retained hardware. Tighten using a 21mm wrench and socket. **See Photo 6.**

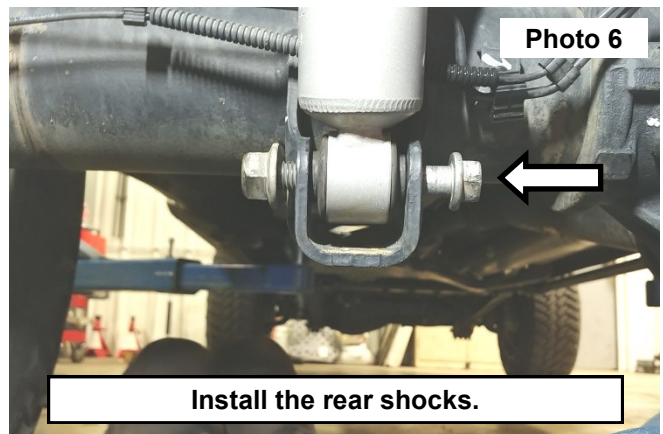
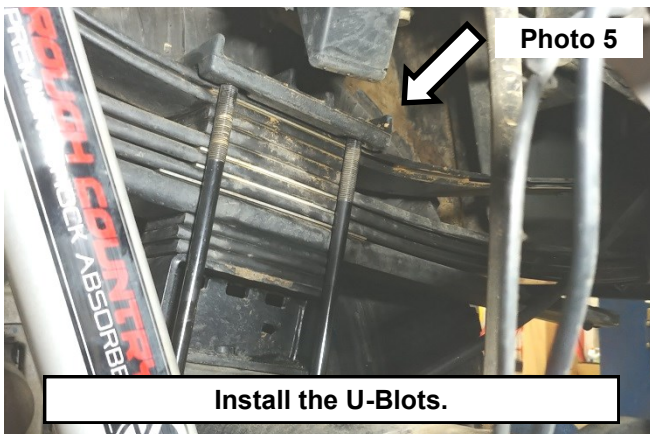

By purchasing any item sold by Rough Country, LLC, the buyer expressly warrants that he/she is in compliance with all applicable, State, and Local laws and regulations regarding the purchase, ownership, and use of the item. It shall be the buyers responsibility to comply with all Federal, State and Local laws governing the sales of any items listed, illustrated or sold. The buyer expressly agrees to indemnify and hold harmless Rough Country, LLC for all claims resulting directly or indirectly from the purchase, ownership, or use of the items.



E-Brake Bracket Drilling Template

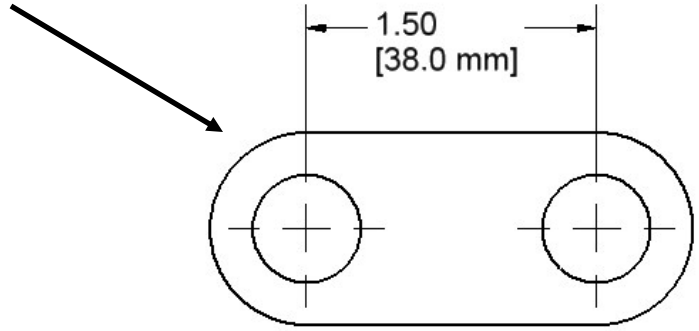

Pass Coil Spring Isolator Drilling Template

