

IMF99



2022+ SUBARU BRZ/TOYOTA GR86 MUD FLAP INSTALLATION INSTRUCTIONS



Manufacturer warranty covers material defects on new, never installed parts. Once installed, all mud flap replacement part costs are the responsibility of the vehicle owner. Caution against blind spots during parking.









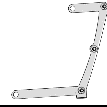

Avoid curbs and excessive compression to the flaps. Check stock and aftermarket wheel/suspension clearances.

INSTALLATION QUESTION? FOR REPLACEMENT PART QUOTES, SEND FLAP RECEIPT OR PHOTO → www.rallyarmor.com/support

Recommended Tools Low-profile offset, ratcheting, flat & Phillips screwdrivers, pick.

ONLY install on even surface using hand tools, not powered tools. AVOID OVERTIGHTENING HARDWARE.

ABOUT OUR STANDARD IN MUD FLAPS Polyurethane is a high grade plastic that may feature minor surface layer marks. These are visual variations that don't affect flap construction or performance. Most matte away as the material ages naturally.

| MF99 KIT CONTENTS CONFIRM ALL PARTS AND QUANTITIES BEFORE INSTALLATION | | | | |
|---|---|----------------------------|-------------------------|-----------------|
| MUD FLAP KIT PN: | MF99 | <i>SEE PAGE 4 DRAWINGS</i> | PART DESCRIPTION | QUANTITY |
| MF99-LF | | | LEFT FRONT | 1 |
| MF99-RF | | | RIGHT FRONT | 1 |
| MF99-LR | | | LEFT REAR | 1 |
| MF99-RR | | | RIGHT REAR | 1 |
| BRACKET PN: BMF99 <i>SEE PG 4</i> | | | | |
| BMF80-RE |  | | BRACKET FRONT | 2 |
| BMF99-LR |  | | BRACKET LEFT REAR | 1 |
| BMF99-RR |  | | BRACKET RIGHT REAR | 1 |
| HARDWARE KIT PN: HMF99 <i>SEE PG 4</i> | | | | |
| .75SP |  | | SPACER | 2 |
| 1SS#8 |  | | SCREW | 2 |
| 1.5SS#8 |  | | LONG SCREW | 8 |
| BLKNUT |  | | NUT | 2 |
| EXPANCH |  | | EXPANSION ANCHOR | 10 |
| HXBLT |  | | PLASTIC BOLT | 2 |
| SMF29-1 |  | | FOAM SPACER | 6 |
| SMWASH |  | | WASHER | 20 |
| SSLNUT |  | | LOCK NUT | 8 |

2022+ SUBARU BRZ/TOYOTA GR86 MUD FLAP INSTALLATION INSTRUCTIONS

FRONT FLAP Bracket/Hardware 1 x Flap → 1 x BMF80-RE; 1 x 1SS#8; 3 x 1.5SS#8; 4 x EXPANCH; 3 x SMF29-1; 5 x SMWASH; 1 x

SSLNUT

To gain access inner wheel well area, turn steering wheel towards installation side. **Do not fully tighten fasteners until mud flap is completely aligned to vehicle.**

FIGURE A Remove factory fasteners 1 - 4.

FIGURE B To expand EXPANCH, insert a pick ½" into mounting hole. Install EXPANCH into mounts 1 – 3, then replace liner. Place EXPANCH into mount 4.

FIGURE C Wipe liner clean before installing SMF29-1 over 1 - 3.

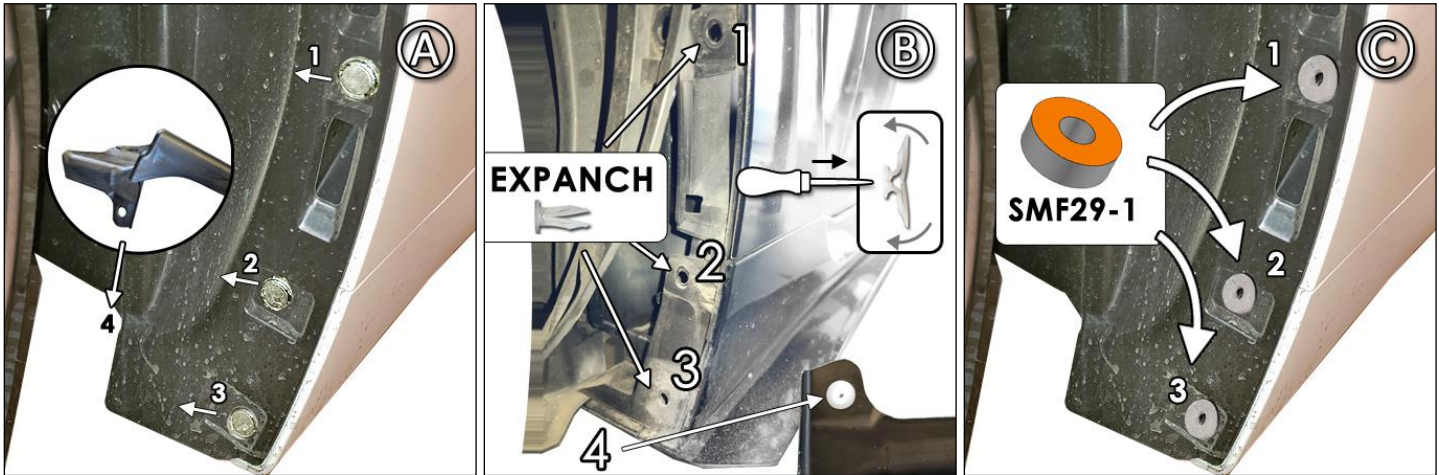
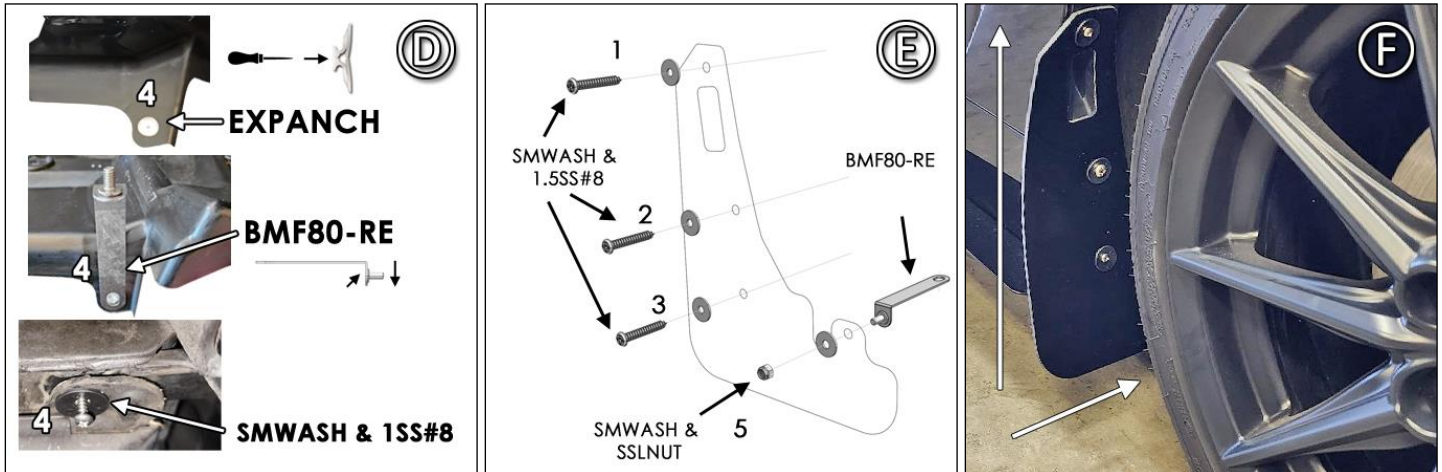

FIGURE D Install SMWASH & 1SS#8 into BMF80-RE mount 4. Bracket mounts between liner and side skirt, stud facing tire.

FIGURE E/F Position logo-side of flap facing vehicle rear. Fasten SMWASH & 1.5SS#8 into mounts 1 - 3. Install SMWASH & SSLNUT onto mount 5. Align flaps to even ground before tightening fasteners until washers just seat against flap.



REAR FLAP Bracket & Hardware 1 x Flap → BMF99-LR/RR; 1 x .75SP; 1 x 1.5SS#8; 1 x BLKNUT; 1 x EXPANCH; 1 x HXBLT; 5 x

SMWASH; 3 x SSLNUT; 1 x FACTORY FASTENER

Do not fully tighten fasteners until mud flap is completely aligned to vehicle.

2022+ SUBARU BRZ/TOYOTA GR86 MUD FLAP INSTALLATION INSTRUCTIONS

FIGURE G Remove factory fastener, then install EXPANCH.

FIGURE H Temporarily remove and retain factory fastener 2.

FIGURE I Gently curve top-end of BMF99-LR/RR to nest against wheel well.

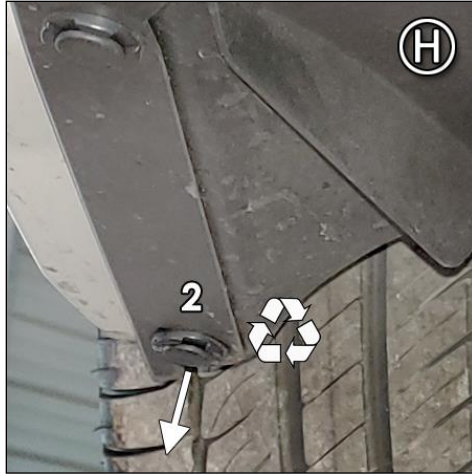
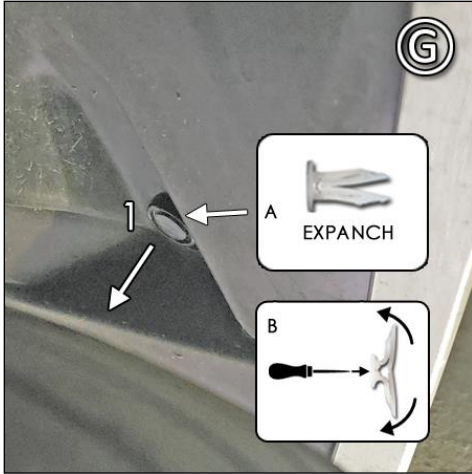
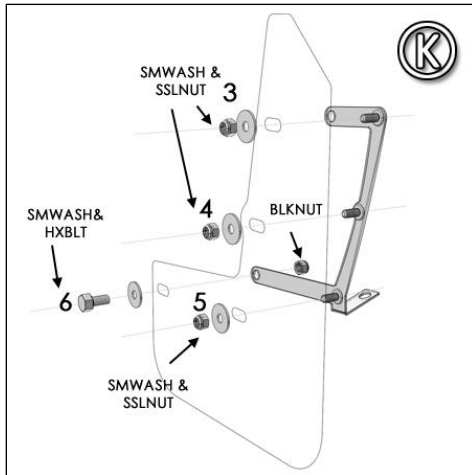
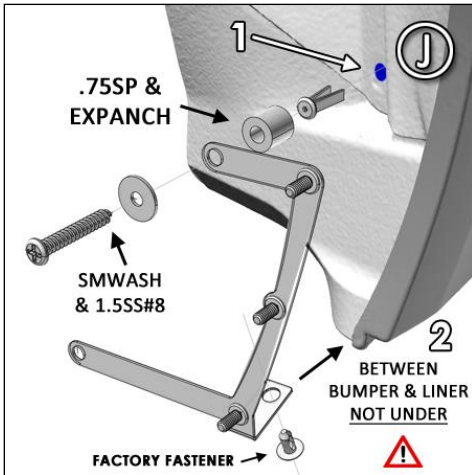

FIGURE J Install SMWASH & 1.5SS#8 into BMF99-LR/RR, & .75SP mount 1. Place BMF99-LR/RR between bumper and liner. Reinstall factory fastener into mount 2.

FIGURE K Place logo-side of flap against BMF99-LR/RR. Install SMWASH & SSLNUT into mounts 3 – 5 and SMWASH, HXBLT & BLKNUT into mount 6.

FIGURE N Align flaps to even ground before tightening fasteners until washers just seat against flap.



IMF99



2022+ SUBARU BRZ/TOYOTA GR86 MUD FLAP INSTALLATION INSTRUCTIONS

RALLYARMOR[®] MF99 MOUNTING DIAGRAM

FRONT

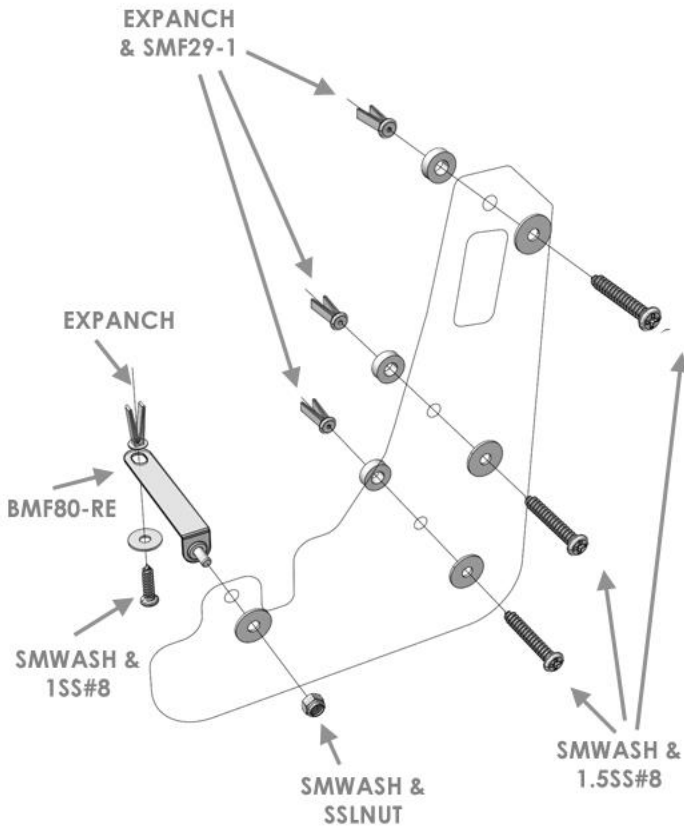

REAR

