



Technical Support Line: (952) 985-5675 Email: Info@QA1.net

### INSTALLATION INSTRUCTIONS

QA1 P/N 52897 Rear Sway bar  
'63-'72 Chevrolet/GMC C Series Pickup

READ ALL INSTRUCTIONS CAREFULLY AND THOROUGHLY PRIOR TO STARTING INSTALLATION. PRODUCTS THAT HAVE BEEN INSTALLED ARE NOT ELIGIBLE FOR RETURN. USE THE PROPER JACKING LOCATIONS. DEATH OR SERIOUS INJURY CAN RESULT IF INSTRUCTIONS ARE NOT CORRECTLY FOLLOWED. A GOOD CHASSIS MANUAL, AVAILABLE AT YOUR LOCAL PARTS STORE, MAY ALSO AID IN YOUR INSTALLATION.

#### • DISCLAIMER / WARRANTY •

QA1 WARRANTS THAT THE PRODUCTS WILL BE FREE FROM DEFECTS IN MATERIAL AND WORKMANSHIP FOR ONE YEAR FROM DATE OF SALE TO THE ORIGINAL PURCHASER. QA1 MAKES NO OTHER WARRANTY OF ANY KIND, EXPRESS OR IMPLIED. QA1 SHALL HAVE NO OBLIGATION UNDER THE FOREGOING WARRANTY WHERE THE DEFECT IS THE RESULT OF IMPROPER OR ABNORMAL USE, YOUR NEGLIGENCE, VEHICLE ACCIDENT, IMPROPER OR INCORRECT INSTALLATION OR MAINTENANCE, NOR WHEN THE PRODUCT HAS BEEN REPAIRED OR ALTERED IN ANY WAY. QA1'S LIABILITY IN THE CASE OF DEFECTIVE PRODUCTS SUBJECT TO THE FOREGOING WARRANTY SHALL BE LIMITED TO THE REPAIR OR REPLACEMENT, AT QA1'S OPTION, OF THE DEFECTIVE PRODUCTS.

THE USER UNDERSTANDS AND RECOGNIZES THAT RACING PARTS, SPECIALIZED STREET ROD EQUIPMENT, AND ALL PARTS AND SERVICES SOLD BY QA1 ARE EXPOSED TO MANY AND VARIED CONDITIONS DUE TO THE MANNER IN WHICH THEY ARE INSTALLED AND USED. QA1 SHALL BEAR NO LIABILITY FOR ANY LOSS, DAMAGE OR INJURY, EITHER TO A PERSON OR TO PROPERTY, RESULTING FROM THE INSTALLATION, DIRECT OR INDIRECT USE OF ANY QA1 PRODUCTS OR INABILITY BY THE BUYER TO DETERMINE PROPER USE OR APPLICATION OF QA1 PRODUCTS. WITH THE EXCEPTION OF THE LIMITED LIABILITY WARRANTY SET FORTH ABOVE, QA1 SHALL NOT BE LIABLE FOR ANY CLAIMS, DEMANDS, INJURIES, DAMAGES, ACTIONS, OR CAUSES OF ACTION WHATSOEVER TO BUYER ARISING OUT OF OR CONNECTED WITH THE USE OF ANY QA1 PRODUCTS. MOTORSPORTS ARE DANGEROUS; AS SUCH, NO WARRANTY OR REPRESENTATION IS MADE AS TO THE PRODUCT'S ABILITY TO PROTECT THE USER FROM INJURY OR DEATH. THE USER ASSUMES THAT RISK!

### TOOLS AND SUPPLIES REQUIRED

- Floor Jack
- Jack Stands
- SAE Wrench Set
- Square
- Ratchet & SAE Socket Set
- Drill with 3/8" bit
- Grinder or Air Chisel
- Tape measure

### Pre-Installation Note

P/N 52897 is recommended for use with QA1 rear coil-over conversion for C10 as the sway bar end links mount in the factory shock mounting positions. A grinder and punch or air chisel is recommended for removal of the factory shock mount brackets.

### Installation Instructions

1. Raise the vehicle and support with jack stands on a stable surface.
2. Unbolt and remove the rear shocks if they are still installed.
3. Remove the rivets for the factory shock mounts on the frame. See **Figure 1**.
4. Use supplied hardware to loosely install the QA1 sway bar brackets to the frame using the existing hole from the shock mount bracket. Note: The brackets are right and left specific. The straight bracket mounts on the right side of the vehicle and the offset bracket on the left. See **Figure 2**.

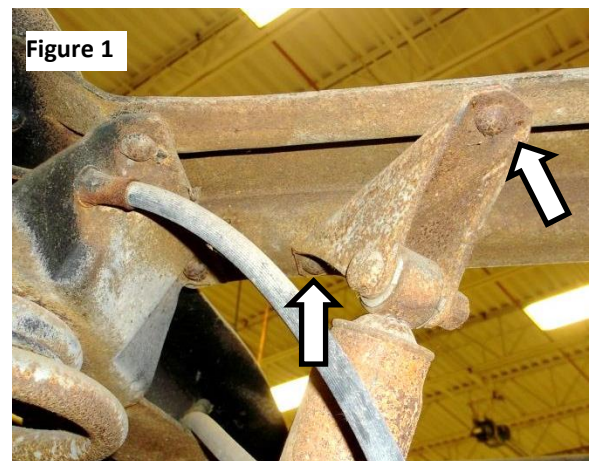

- Using a square, position the brackets at 90 degrees to the cross member and drill one 3/8" hole for each bracket. Install and snug the 3/8" bolts. **Note:** The forward bolts must be installed from the bottom up.
- Select the mounting tabs for the sway bar mount based on the amount of rear suspension drop. The longer tabs are used for stock height trucks to a drop of 4". The shorter tabs are used for lower trucks. Mount the tabs inside the bracket and install bolts as shown in **Figure 3**.

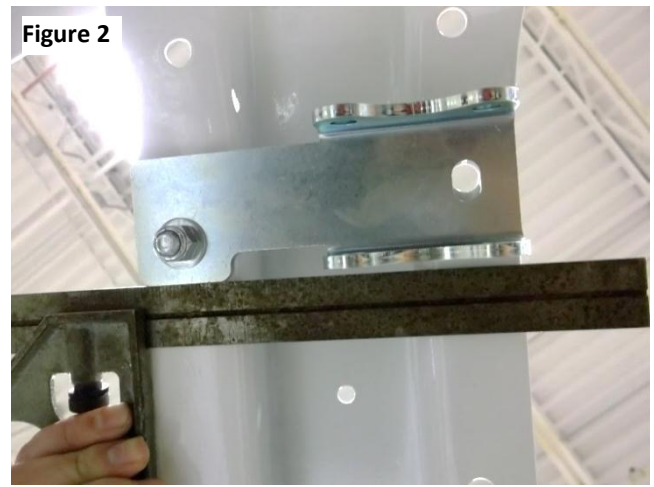

**Figure 3**

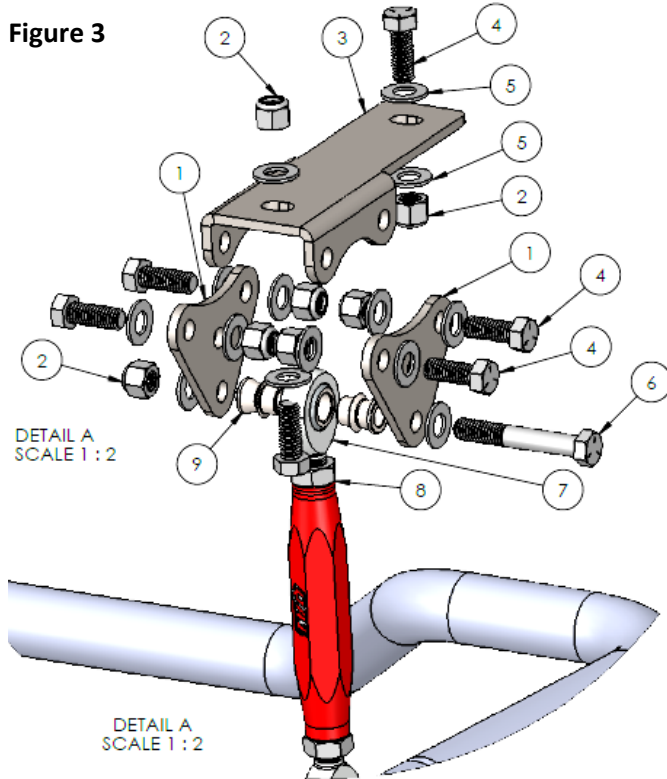

**Figure 4**

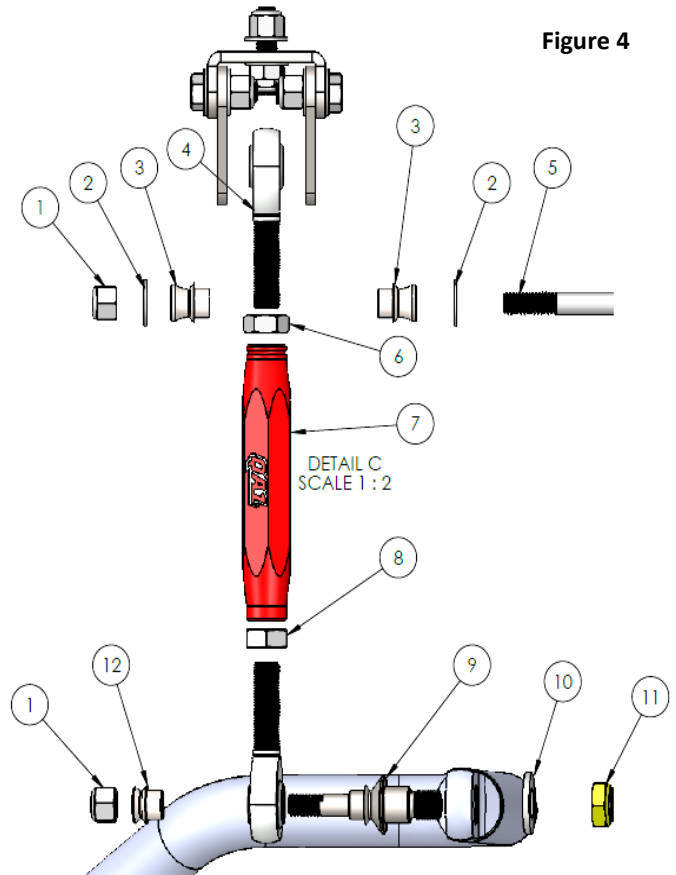

BALLOON #	ITEM #	DESCRIPTION	QTY.
1	9037-603	C10 4-6 REAR DROP PLATE	4
2	9014-253	3/8-16 NYLOCK	16
3	9037-600	BRACKET, REAR SWAY BAR, DRIVER SIDE	1
4	9012-229	3/8-16 x 1.00	12
5		WASHER, 3/8 SAE	28
6	9012-190	3/8-16 x 2.50	2
7	XML8	ROD END, 5/8 LH	2
8		0.5-20 JAM LH	2
9	SG8-67	High Misalignment Spacer, SS	4

BALLOON #	ITEM #	DESCRIPTION	QTY.
1	9014-253	3/8-16 NYLOCK	16
2		WASHER, 3/8 SAE	28
3	SG8-67	HIGH MISALIGNMENT SPACER, SS	4
4	XML8	ROD END, LH	2
5	9012-190	3/8-16 X 2.50	2
6		1/2-20 JAM LH	2
7	9033-459	SLEEVE, .875" HEX ALUMINUM ANODIZED	2
8		1/2-20 JAM	2
9	9029-309	HIGH MISALIGNMENT STUD	2
10		WASHER, 1/2 SAE	2
11		NUT, NYLOCK 1/2-20	2
12	SG8-64	HIGH MISALIGNMENT SPACER, SS	2

- Assemble the sway bar end links with the rod ends and jam nuts. Thread the rod ends all the way into the sleeve to ensure the same amount thread on each end. Attach the end links to the upper mount and to the sway bar with the provided spacers as shown in **Figure 4**. Tighten the bolts to 30 lb. ft. **NOTE: DO NOT OVER TIGHTEN THE BOLTS!** Over tightening could deform the spacers causing the bolts to be stuck in the spacers.

- Grease and install the bushings on the QA1 sway bar and mount the new axle brackets and U-bolts loosely on the axle tube.

9. Measure off of the center section to the axle mounts approximately 2 ¼" to ensure the brackets are equally spaced on the axle. Position the brackets so they are parallel to the ground and tighten the nuts on the U-bolts. See **Figure 5**.
10. Check all hardware for tightness. Adjust the sway bar end links so the arms are level with the truck sitting at ride height and tighten the jam nuts on the links.

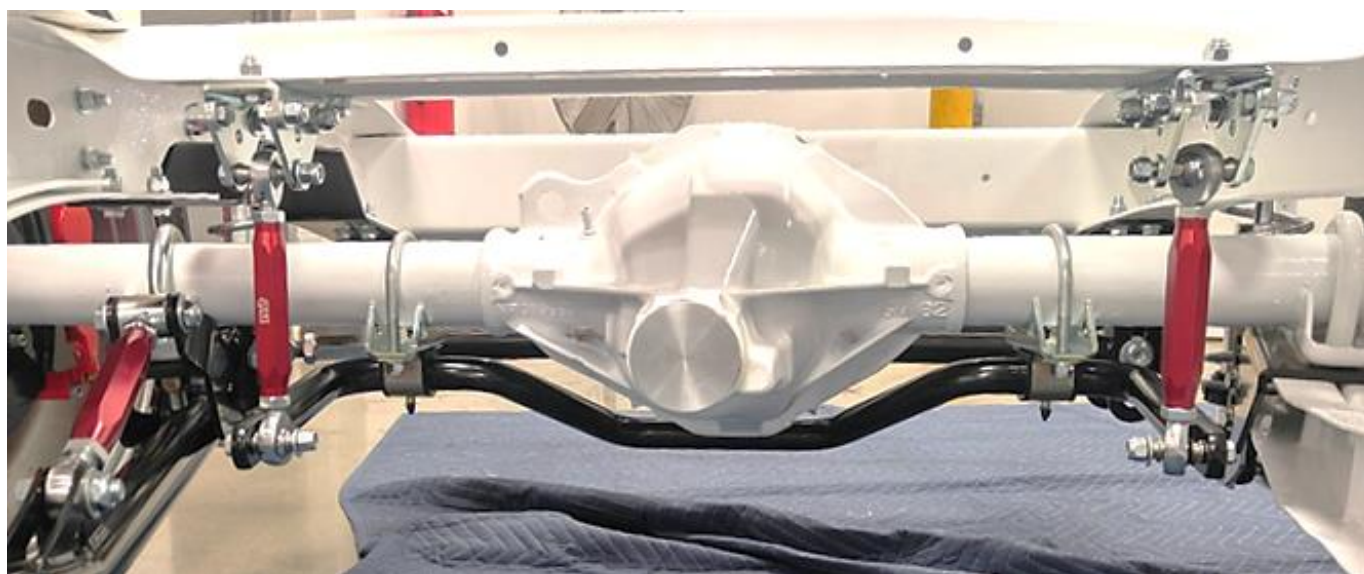
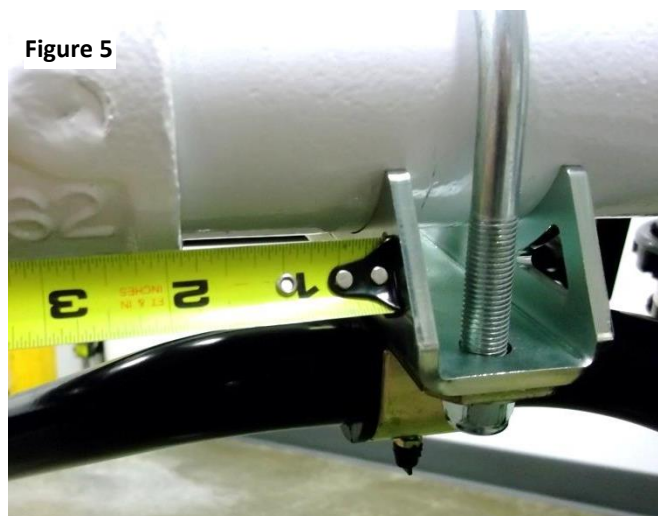

## Dedicated Technical Support Team

QA1 is dedicated to providing quality support and instructions. We employ passionate racers and car enthusiasts that know our products and the industry to better serve you.

Check out our tech videos at [www.YouTube.com/QA1Tech](http://www.YouTube.com/QA1Tech) for:

- Frequently Asked Questions
- Quick Tips
- Install Information
- Tuning and Repair Guides
- Other technical information

Or call to speak with one of our experts: 1.800.721.7761

\*Our technical support and order lines are open Monday - Friday, 8 am to 5 pm CST.



Facebook.com/QA1Motorsports



Twitter.com/QA1Motorsports



Instagram.com/QA1Motorsports

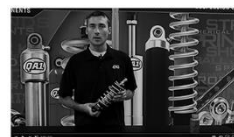

[www.QA1.net/Tech](http://www.QA1.net/Tech)