

# Installation Manual

**PACBRAKE®**

www.pacbrake.com 800.663.0096



## CUMMINS 6.7L EXHAUST BRAKE

**PRXB**

**PRXB EXHAUST BRAKE KIT  
FOR TRUCKS EQUIPPED WITH 6.7L  
CUMMINS ISB DIESEL ENGINES\***

**C44038 4" Kit • C44039 5" Kit**

*\*See PRXB Application Guide for proper fitment*



L6299\_REV4\_ECN1-1963

**BEFORE STARTING THE INSTALLATION** please read the entire installation manual carefully. Check that your Pacbrake kit is correct for the application and contains all the necessary parts.

*NOTE: Due to the high complexity of the emission system strategy and the fact that the Pacbrake controller monitors the injector signals, you may experience a very rare event of unexpected exhaust brake interruption.*

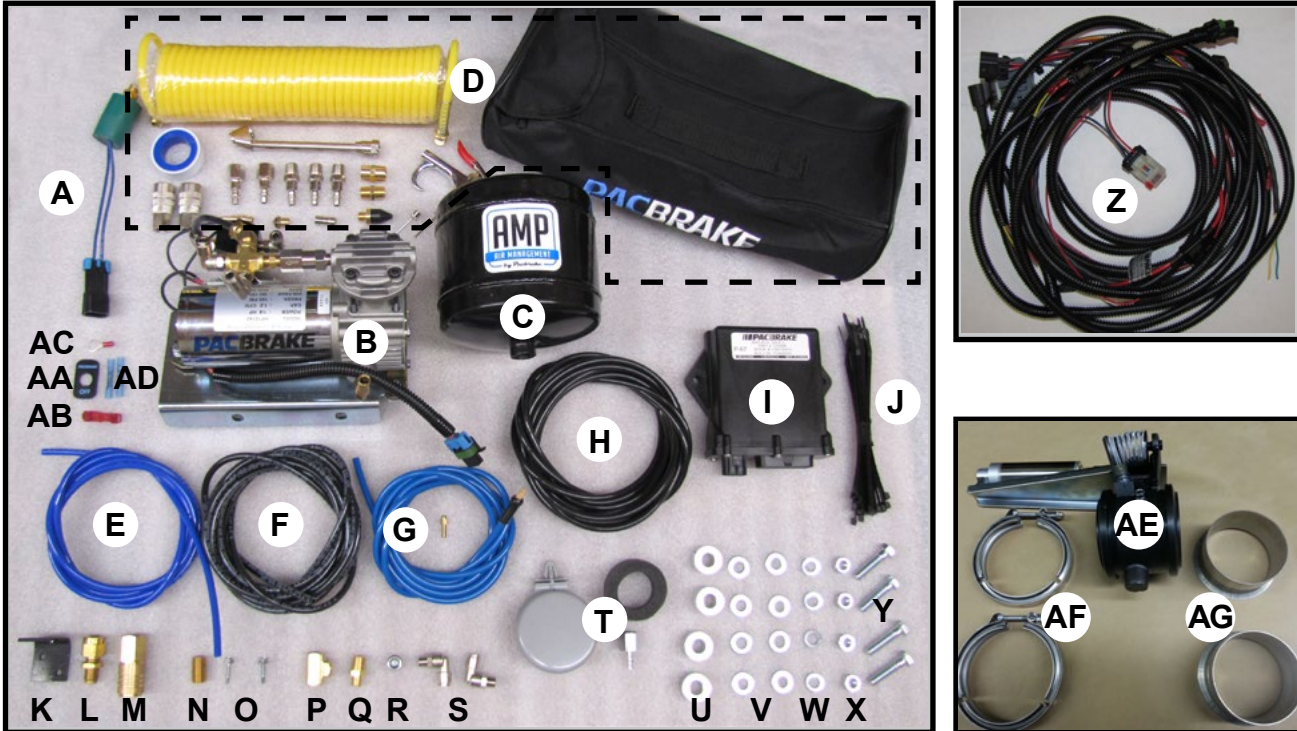

## KIT CONTENTS

- |   |  |
|---|--|
| <b>A</b> C11609 - Pressure Switch (1)   | <b>R</b> C11848 - 1/4" NPT Hex Plug (1)                        |
| <b>B</b> C11627 - HP325 AMP Air Compressor Assembly (1)   | <b>S</b> HP1019 Brass Fitting (2)                              |
| <b>C</b> C11614 - 1/2 Gallon AMP Air Tank (1)   | <b>T</b> C241 - Remote Inlet Air Filter (1)                    |
| <b>D</b> C11652 - Air Accessories Kit (1)<br><i>25ft airline, with fittings and nylon storage bag</i> | <b>U</b> C3004 - Spacer (4)                                    |
| <b>E</b> M8685 - Nylon Airline (1)  | <b>V</b> C653 - Flat Washer (8)                                |
| <b>F</b> M8280 - Nylon Air Brake Line (1)   | <b>W</b> C18007 - Lock Washer (4)                              |
| <b>G</b> C20146 - Remote Breather Kit (1)   | <b>X</b> C11572 - 3/8 Nut (4)                                  |
| <b>H</b> M8280 - Nylon Air Brake Line (1)   | <b>Y</b> C18018 - 3/8 x 1 1/2 Bolt (4)                         |
| <b>I</b> C20255 - Controller (1)  | <b>Z</b> C20531 - Harness (1)                                  |
| <b>J</b> C11618 - Tie Straps (24)   | <b>AA</b> P01305 - Switch Plate (1)                            |
| <b>K</b> C11815 - Quick Release Bracket (1)   | <b>AB</b> M8194 - Ring Terminal (1)                            |
| <b>L</b> HP1152 - Bulk Head Fitting (1)   | <b>AC</b> M8107 - T-Tap (1)                                    |
| <b>M</b> M8677 - 1/4" Brass Coupler (1)   | <b>AD</b> M8028 - Butt Connector (2)                           |
| <b>N</b> HP1153 - 1/4" NPT Hex Plug (1)   | <b>AE</b> C40128 (4") or C40211 (5")<br>PRXB Exhaust Brake (1) |
| <b>O</b> P60100 - Self Tapping Screws (2)   | <b>AF</b> C11350 (4") or C10620 (5")<br>Clamps (2)             |
| <b>P</b> C11737 - Brass Fitting (1)   | <b>AG</b> C11342 (4") or C11354 (5")<br>Adapters (2)           |
| <b>Q</b> C11996 - Fitting (1)   |  |

## GETTING STARTED

### 1 Electrical Installation

Consult with the customer for their choice of Pacbrake control switch location.

A recommended location is the area behind the turn signal indicator, just above the lower dash panel.

The lower dash panel needs to be removed to gain access. The dash switch requires a ½" hole be drilled to accommodate the dash switch.

Install the Pacbrake switch and switch plate (as shown).



### 2 Remove the driver side knee panel to gain access to the base of the steering column.

At the base of the steering column, locate the PINK with WHITE tracer wire. This is a 12 VDC ignition power supply.

Install the RED t-tap connector onto this wire and connect to the RED fused wire of the Pacbrake switch harness.

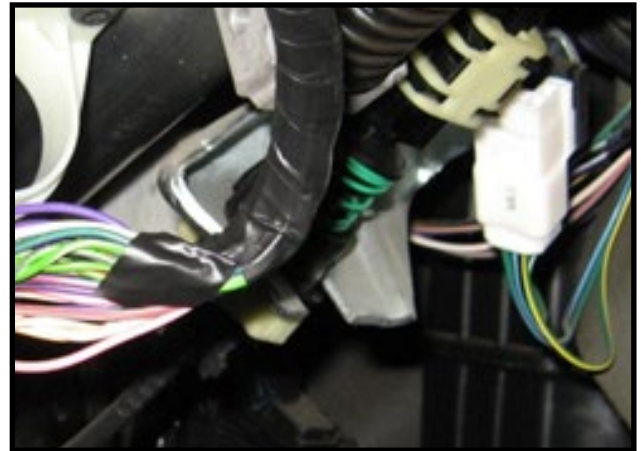

### 3 Disconnect the negative and positive battery terminals from BOTH batteries.

Route the switch harness through the fire wall, to the driver side of the engine compartment.

Mount the controller to the power steering lines with the supplied tie straps.

- 4** Connect the 4 wires from the Pacbrake switch harness to the coinciding wires of the harness connected to the Pacbrake controller. Heat shrinkable butt connectors are provided.

Once crimped, heat the connector to provide a water tight seal.

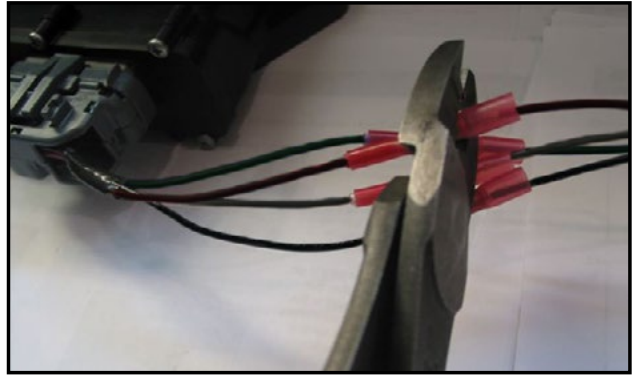

- 5** Route the BLACK wire of the harness to the negative terminal of the driver's side battery.

Crimp on the RED ring terminal and connect to the negative terminal stud. Route the RED wire with 30 AMP fuse of the harness to the driver's side battery.

Connect to the positive terminal.

- 6** Route the twisted & jacketed, YELLOW and GREEN wires of the Pacbrake harness to the forward injector harness plug and secure with the supplied tie straps.

Cut to length and strip off 3" of the jacket.

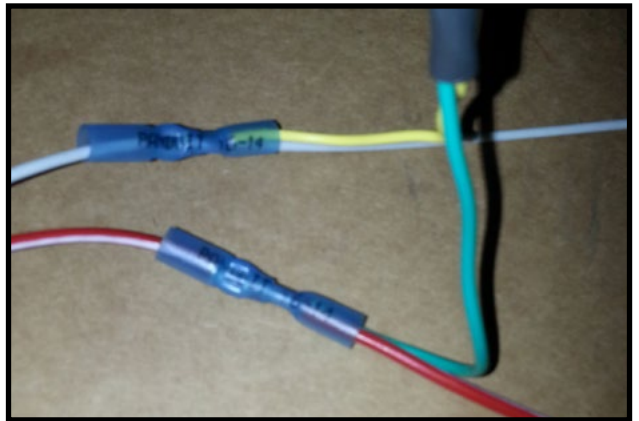

- 7** Using the supplied heat shrinkable BLUE butt connectors, splice the GREEN wire of the Pacbrake harness into the wire located in port "A" of the factory injector harness.

(See attached photo for port locations).

Splice the YELLOW wire of the Pacbrake harness into the wire located in port "B" of the factory injector harness.

Using a heat gun, shrink and secure all the butt connectors.

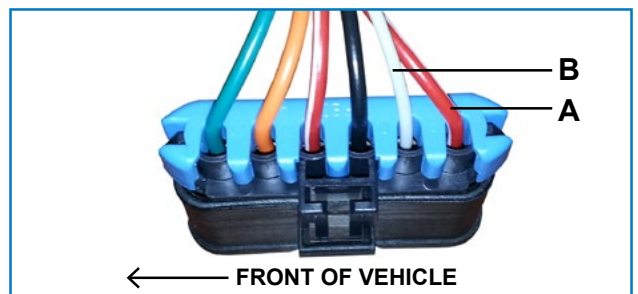

- 8** Route the blue wire of the Pacbrake harness to the Crankshaft Speed Sensor, located below the harmonic balancer on the driver's side of the engine.

Unlock and unplug the factory harness connector.

Obtain the supplied crankshaft sensor jumper end of the harness, connect the female connector to the crankshaft sensor and lock. See photo 8A of lock/unlocked positions.

Connect the factory female connector to the male connector of the jumper harness, and lock.

Secure the blue wire with the provided tie straps away from any moving parts or high heat sources.

UNLOCKED position is shown.  
(When LOCKED, you see red on both sides).

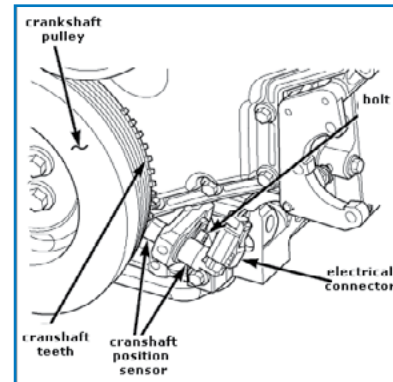

- 9** Secure all wires away from moving parts and heat sources using the supplied tie straps.

*NOTE: wiring will be concluded in step 14.*



- 10** Install the 1/4" NPT-1/4" push on barbed hose fitting onto the plastic filter housing. Locate the Blue nylon hose and connect one end to the barbed fitting on the intake filter. Install the compressor air intake filter into the hole located in the radiator support bracket behind the driver side headlight as shown in the photo. Or any cool dry location. Route this line down to the driver side rear of the bumper.

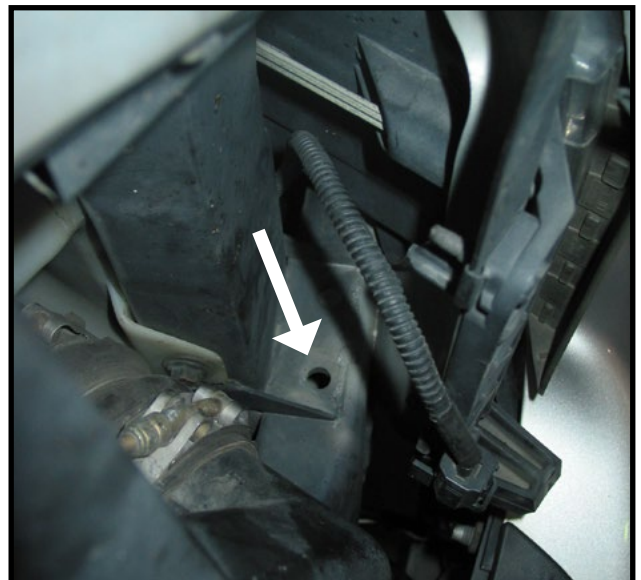

- 11** Mount the air compressor / solenoid assembly of the driver's side bumper support brace shown in the photo. Drill two  $\frac{3}{8}$ " holes on  $3\frac{3}{4}$ " center to accommodate the compressor mounting holes. Provided are two spacers and fasteners for mounting. Torque fasteners to 23ft-lbs, (31 N•m)

*NOTE: It will be easier to connect the blue nylon hose of the compressor intake filter before mounting the compressor assembly. The compressor intake is located on the crank case of the compressor, as shown in picture 11C.*

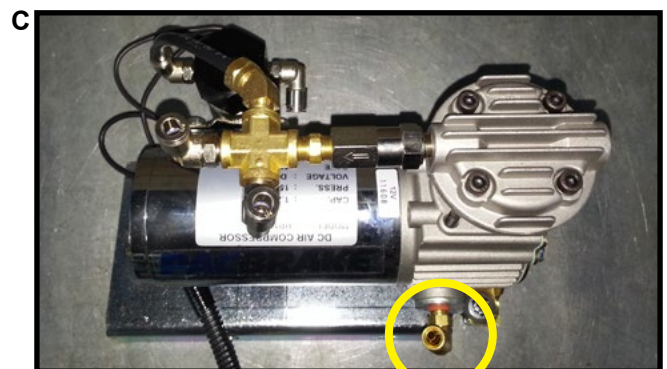

- 12** Apply thread sealant to all fittings installed.

Install the  $\frac{1}{4}$ " NPT to  $\frac{1}{8}$ " NPT nipple into the top of the air tank. Install one 90 °push to connect airline fitting into one end of the tee fitting.

Install the Tee fitting on to the top of the nipple, as shown in the photo. Install the pressure switch into the open port of the the tee fitting.

Install the  $\frac{1}{4}$ "NPT plug fitting or drain valve (optional) into the bottom of the tank.

Air leaks will cause the compressor to cycle more often reducing its life expectancy.



- 13** Mount the air tank assembly on the passenger's side bumper support brace shown in the photo. Drill two  $\frac{3}{8}$ " holes on  $3\frac{3}{8}$ " center to accommodate the tank mounting holes. Provided are two spacers and fasteners for mounting. Torque fasteners to 23ft-lbs, (31 N•m)



- 14** Route the Pacbrake harness forward and down to the compressor, connect the mating Metri-Pac connector of the compressor assembly to the harness. Continue routing the harness toward the air tank, connect the mating Metri-Pac connector of the harness to the pressure switch.



- 15** **CAUTION:** This kit includes "push to connect OR barbed" airline fittings. They require the end of the airline to be round, square and cleanly cut to ensure the internal seal will not leak. The airline must only be cut with a sharp razor knife.

Using the supplied black nylon airline, trim one end of the hose and connect to the fitting on top of the air tank assembly, route the hose back to the compressor assembly, cut to length and connect to either fitting on the compressor outlet.

Using the supplied black nylon airline, connect to the unused fitting of the solenoid assembly, route this along the rear of the front bumper and along the passenger's side frame rail. This will get connected to the exhaust brake in step 20.

Secure all wires away from moving parts and heat sources using the supplied tie straps.

- 16** Using the remaining length of airline, connect one end to the remaining fitting at the air compressor. Consolidate with the customer for a preferred location for the quick connect airline couple.

Secure the airline away from moving parts and heat sources using the tie straps provided.



**17 BEFORE INSTALLING THE EXHAUST BRAKE PART OF THIS KIT, PLEASE CHECK THE FOLLOWING:**

- Confirm the exhaust pipe outside diameter is not greater than the adapter provided. The adapters are expanded to slip over the exhaust pipe to make welding easier.
- Confirm all the exhaust system connections between the exhaust brake and the cylinder head will withstand 60 PSI without leaking. Clamped connections must be welded.

Install the 90° fitting provided into the Pacbrake air cylinder using thread sealant. Remove the breather on the cylinder and install the barbed fitting as per Service Bulletin L6172 (included in the information package). <http://www.pacbrake.com/PDF/L6172.PDF>

**4" EXHAUST ONLY**

Select a location that has a minimum of 12" of straight pipe and has sufficient clearance for installation and servicing of the exhaust brake.

This location should be as close to the turbocharger as possible and away from dirt and road spray. A 7" section of exhaust pipe needs to be removed. Measured and mark the pipe for cutting.



**5" EXHAUST ONLY**

Select a location that has a minimum of 12" of straight pipe and has sufficient clearance for installation and servicing of the exhaust brake. This location should be as close to the turbocharger as possible and away from dirt and road spray. A 9" section of exhaust pipe needs to be removed. Measured and mark the pipe for cutting.





- 18** Install the heavy duty “V” clamp and one adapter on the pressure side flange (and adapter ring if necessary). Install the low pressure side “V” clamp and adapter loosely, then insert into the exhaust system. Adjust the exhaust brake and exhaust system to attain clearance and tack weld the adapters in place, being careful to maintain the proper length and angles that exist. Weld the adapters to the sections of pipe. Welding can be done on the outside or the inside of the adapter, but it must be leak free.

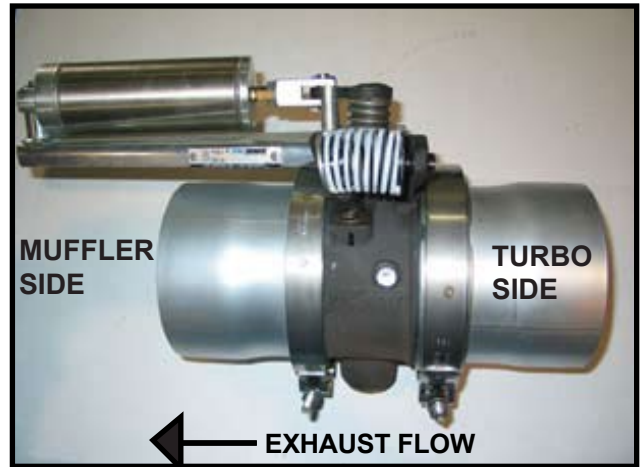

- 19** If removed, re-install the front section of pipe on the engine. Torque the turbo “V” clamp to the manufacturer’s specifications.

Center the Pacbrake on the pressure side adapter and install the heavy duty “V” clamp. Torque to 10 ft-lbs. Install the rear section of pipe to the Pacbrake and install the remaining “V” clamp loosely. Check the alignment of the exhaust system and adjust if necessary. Then torque both “V” clamps to 10 ft-lbs.

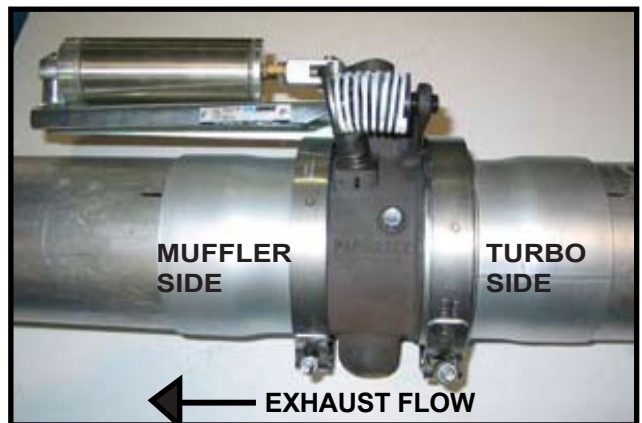

- 20** Continue routing the black nylon air line from the air solenoid, installed in step 14, to the inlet fitting of the exhaust brake air cylinder. Connect to the 90° air fitting.

- 21** Secure ALL airlines and harness runs with the tie-straps provided.

## OPERATION

For optimal braking, the following switches must be in the 'ON' position:

- **Tow/Haul** (to provide auto-downshifting in RAM / Sterling trucks with auto transmissions)
- **Exhaust Brake**

Automatic transmissions need to turn on the factory Exhaust brake switch as well as the pacbrake switch. This will allow the transmission to lock up and downshift automatically.

## PLUMBING DIAGRAM

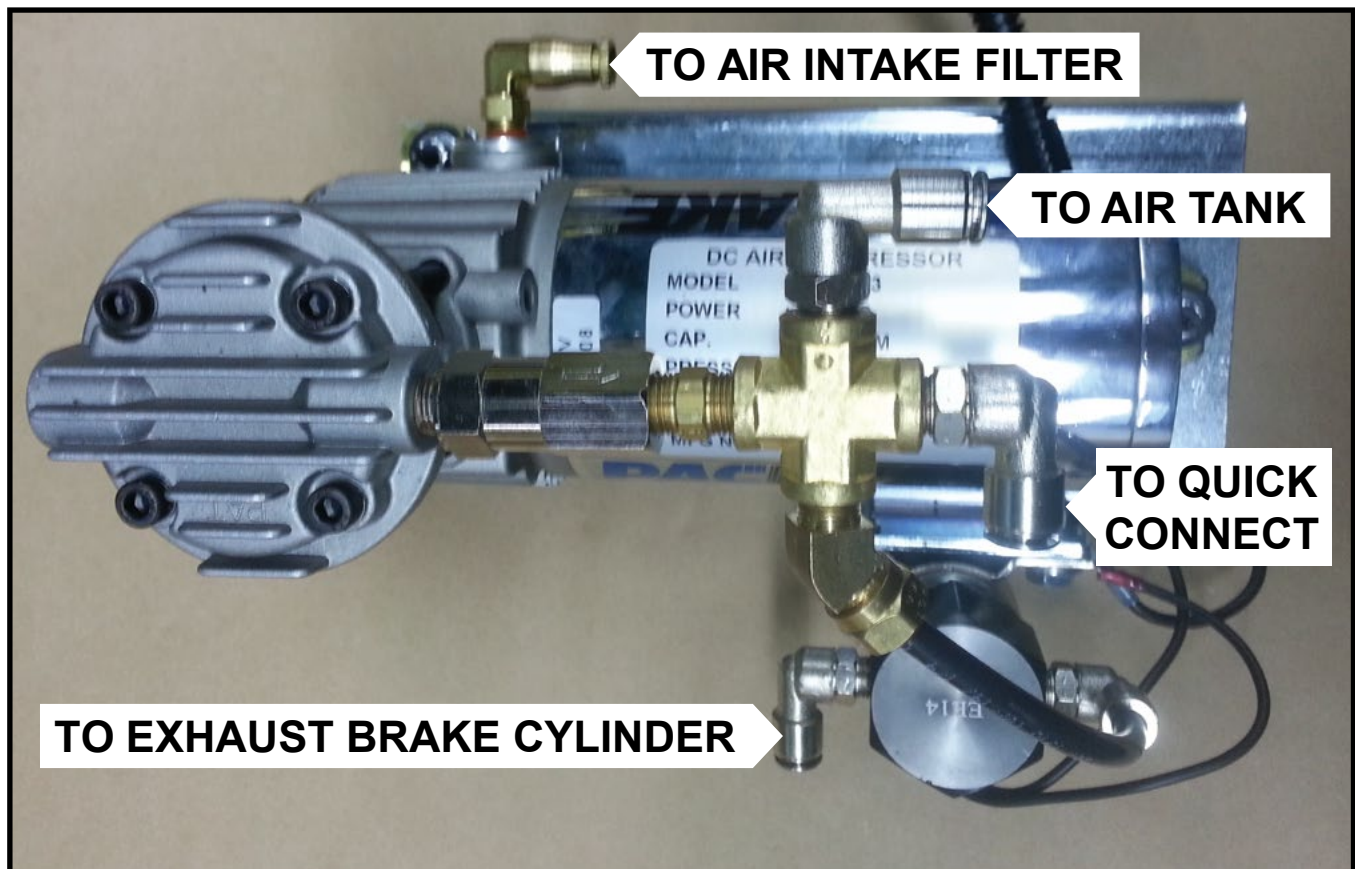

WIRING SCHEMATIC

