

# Installation Manual

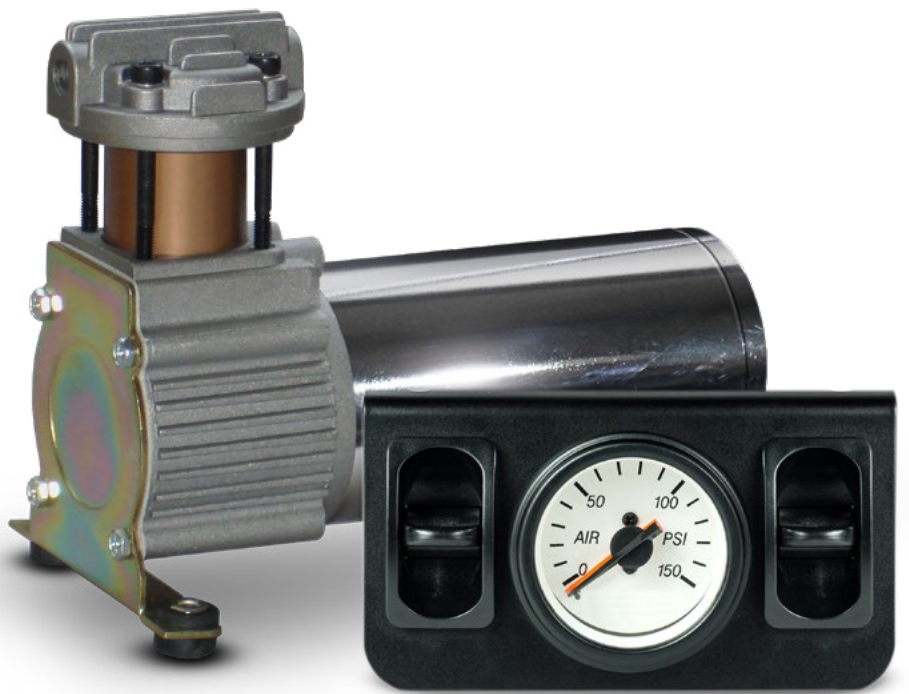

## 10098

Universal Vehicle Applications

*Use this kit in conjunction with air tank kits and air compressor kits to build your own customizable onboard air system.*

**Thank you and congratulations on the purchase of a Premium Independent Paddle Valve In-Cab Control Kit with Mechanical Gauge.**

Please read the installation manual prior to starting to ensure you can complete the installation once started.

**NOTE: The existing vehicle air system must be capable of 100 PSI.**



**PLEASE NOTE:**  
*These kit contains push-to-connect fittings, using scissors or wire cutters to cut the nylon airline will distort the line and cause the connection to leak. THE AIRLINE MUST BE CUT OFF SQUARELY WITH THE NYLON HOSE CUTTER PROVIDED IN THIS KIT OR A SHARP UTILITY KNIFE.*

**BEFORE STARTING THE INSTALLATION:**

It is recommended to use a good quality anti-seize on all fasteners. This will reduce the chance of corrosion on the fasteners and will help facilitate removal, if required at a later date.

**1 INSTALL THE AIR SPRING ASSEMBLIES (if not previously installed).**

Follow the installation instructions provided in your air spring kit.

Use the red and green nylon hoses provided in the control system kit to connect the air springs to the control panel as they are longer than the black nylon hoses provided in the kit.

Connect the green nylon hose to the right side air spring and the red nylon hose to the left side air spring.

Route these airlines to the control panel mounting location.



1

## 2 SOURCE AIR FROM THE TANK.

**PLEASE NOTE:** This kit contains push-to-connect fittings; using scissors or wire cutters to cut the nylon airline will distort the line and cause the connection to leak. THE AIRLINE MUST BE CUT OFF SQUARELY WITH THE NYLON HOSE CUTTER PROVIDED IN THIS KIT OR A SHARP UTILITY KNIFE

Install the tee fitting and straight push-to-connect fitting provided into the top of the air tank. Cut the end of the black nylon hose off squarely with the hose cutter provided in this kit or a sharp razor knife, then insert it into the push-to-connect fitting until it clicks and stops.

Route this nylon hose into the cab through the firewall boot with the red and green air spring to gauge panel mounting location.

Once complete, secure all 3 nylon hoses away from heat sources and moving components with the tie-straps provided.



2

## 3 COMPONENT MOUNTING

Choose a location to mount the gauge and switch panel. It should be in reach and in clear view to the driver.

Using the bracket as a template, mark and drill two 3/16" diameter holes to secure the bracket.

Do not install the bracket until the electrical and airlines are connected.

**Thread sealant or Teflon tape must be applied to all the fitting threads installed throughout the installation to prevent air leaks.**



3

## 4 INSTALLATION OF THE COMPRESSOR

Install the push to connect fitting into the check valve, then install the assembly into the compressor head, As shown in Figure 3.

The compressor makes an audible pumping noise when activated, consider this when choosing a mounting location. The location should also be in a clean, dry area to maintain long compressor life.

Using the compressor as a template, mark and drill three 3/16" diameter holes. Secure the compressor using the fasteners provided.



4

## 5 COMPRESSOR AIR INTAKE FILTER

Locate the air intake filter housing, barbed fitting and 6' length of blue nylon hose provided in kit.

Choose a location to mount the filter housing within 6' of the compressor, the housing requires a 1/2" hole for mounting, the location must also provide clean dry air.

Secure the barbed fitting to the filter housing, connect the nylon hose to the barbed fitting, install the housing into the mounting hole. Route the nylon hose to the inlet fitting at the compressor, secure the hose with tie-straps provided.



5

## 6 ELECTRICAL CONNECTIONS

Provided in the kit is a pre-wired relay receptacle to make this part of the installation easy. Find a convenient location close to the positive battery terminal to mount the relay receptacle. Using the self tapping screw provided, secure the relay receptacle and install the relay provided.

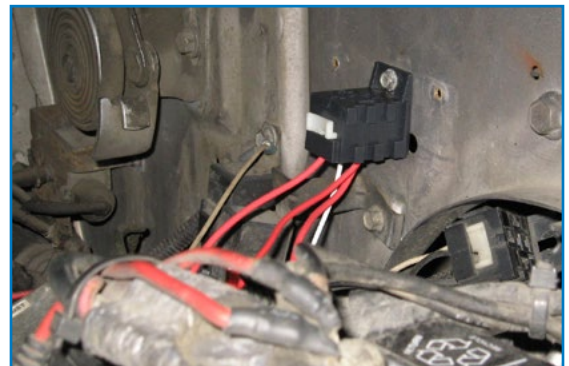

6

- 7 Locate either one of the two red 12 gauge wires of the relay harness. Cut to length and connect the 30 amp fused link.

Connect the 30 amp fused link to the positive terminal of the battery.

Locate the second red 12 gauge wire and route to the compressor. Cut to length and crimp on the supplied blue butt connector, then connect to the red compressor wire.

Locate the black wire of the compressor and connect to a good chassis ground or the negative battery terminal.

Heat the connector's to provide a water tight seal.



7

- 8 Locate the 16 gauge red with white strip and the white wire of the relay harness. Route these two wires into the cab through the firewall boot. Connect the red with white strip wire to the 5 amp inline fuse provided, then to a 12 volt ignition power source using the "T" tap connector provided.

Test the ignition power source with a volt meter prior to attaching the "T" tap. Some ignition circuits are less than 12 volts which may not be enough to activate the relay coil. This wire can be connected through an ON/OFF switch to override the compressor activation, should the customer prefer this option. (Switch not provided in the kit, but available separately)

Heat the butt connectors to provide a water tight seal.

9 ELECTRICAL CONNECTIONS AT THE REAR OF THE GAUGE

The red wire needs to be connected to the dash board illumination circuit using the "T" tap provided.

**NOTE: If the customer does not want the gauge light to dim with the dash lights, the red wire can be connected through an inline fuse to a 12 VDC circuit. The eyelet terminal with the single black wire and two white wires needs to be attached to a good chassis ground.**

- 10 In the cab, locate the white wire routed into the cab in Step 8 (originating at the relay harness).

This wire connects to the white wires at the control panel with a blue heat shrinkable butt connector. Crimp the wire to the connector, then heat the connector to provide a water tight seal.

11 GAUGE PLUMBING

Locate the two 1/8 NPT female "push-to-connect" fittings provided. These fittings are installed on the back of the dual needle gauge. It is recommended to use thread sealant or Teflon tape. When tightening these fittings, hold the jam nut on the back of the gauge fitting to provide support.

Using the black nylon airline provided cut off two 4" lengths. Insert one end of each length on to the barbed "T" fitting provided (see Figure 11A).

Connect the ends of the black nylon hoses to the port on the back of the switch marked "supply" (See Figure 11D, on following page).



8

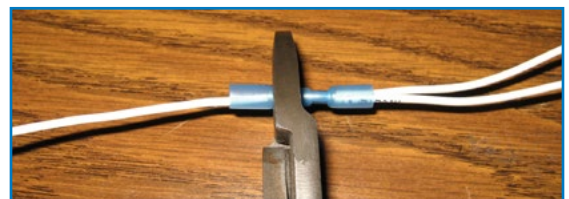

10

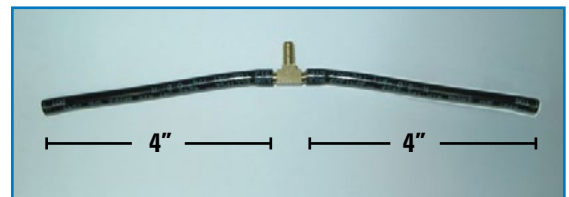

11A

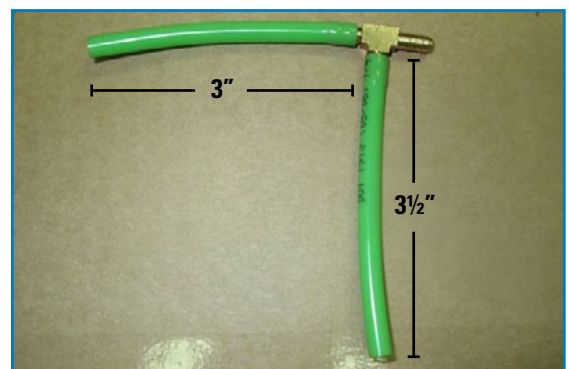

11B

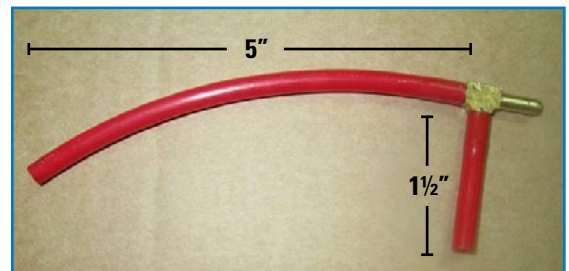

11C

### RIGHT AIR SPRING AIRLINE ASSEMBLY

Cut two pieces of the green airline provided. One to 3", one to 3 1/2". Connect these two airlines to the bared "T" fitting provided, (as shown in Figure 11B on previous page).

Using Figure 11D: Connect the 3 1/2" long airline onto the R/H switch DELIVERY port. Insert the 3" long airline into the left air gauge supply fitting.

**Please note: It is recommended to use a wrench on the flat spot of the threaded ports on the backside of the mechanical gauge, when installing lines. Failure to do so may result in damaged ports**

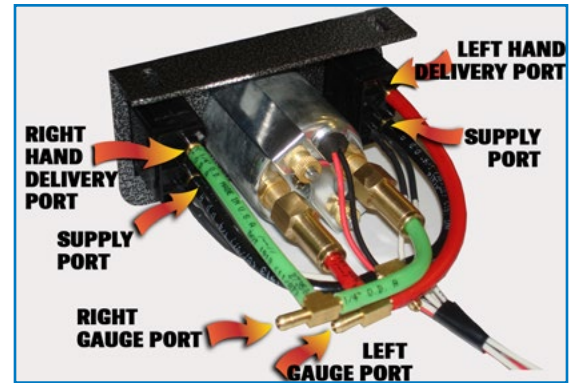

11D

### LEFT AIR SPRING AIRLINE ASSEMBLY

Cut two pieces of the red airline provided: one to 5", the other to 1 1/2". Connect these two airlines to the barbed "T" fitting provided (as shown in Figure 11C on previous page).

(Using Figure 11D:) Connect the 5" long airline onto the L/H switch DELIVERY port. Insert the 1 1/2" long airline into the right air gauge supply fitting.

- 12 Using the hose cutter provided in this kit, or a sharp razor knife, cut the end of the black nylon tube off squarely, push this end firmly into the push-to-connect fitting on the compressor until it stops.

Route the other end of the nylon hose through the firewall boot into the cab then to the gauge and switch panel, (as shown in Figure 12).

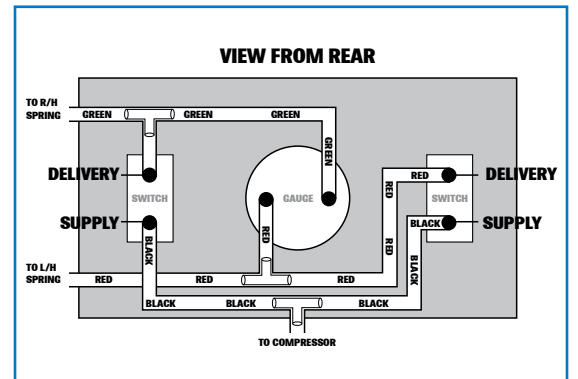

12

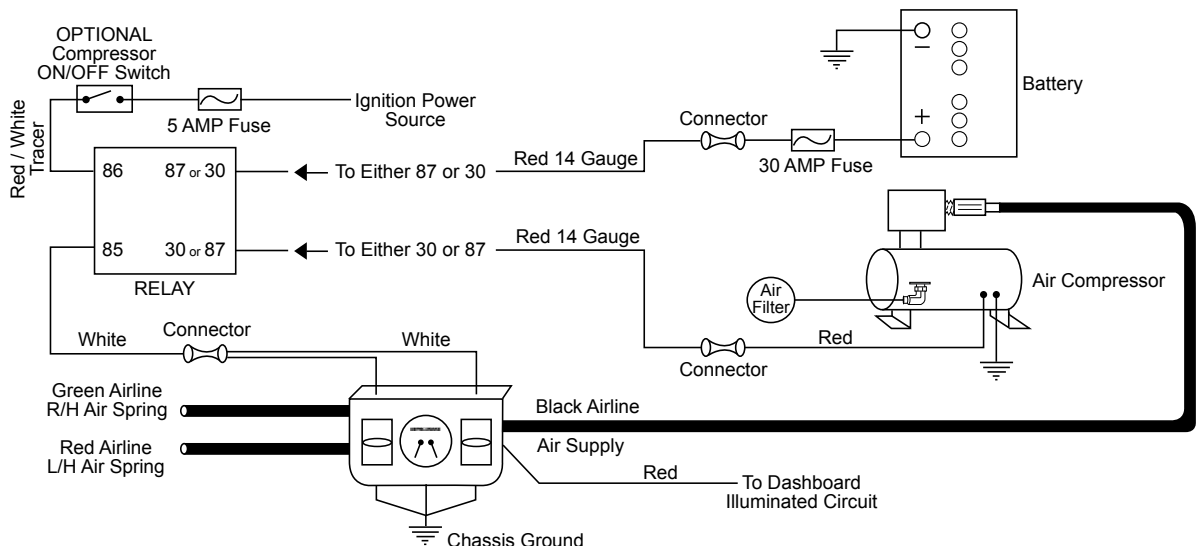

### 13 PLUMBING CONNECTIONS

The remaining lengths of red and green nylon airline are to connect the control panel to the air springs. The airline colour identifies which air spring they will be connected to.

**Red is for the left air spring.**

**Green is for the right air spring.**

Starting at the control panel, route two lengths of nylon airline through the firewall boot and along the frame rail to the correct air spring.

Cut the ends of the airlines off squarely with the hose cutter provided or a sharp razor knife, then push firmly all the way into the fitting at the air spring.

Secure the nylon airline with tie-straps provided.

- 14** At the rear of the control panel, locate the three "T" fittings with different coloured airline. These colours pertain to where they get connected.

**Black is the supply line from the compressor to the control panel.**

**Green is the inflate/deflate line to the right side air spring**

**Red is the inflate/deflate line to the left side air spring.**

See Figure 12 for airline routing.

- 15** Using the fasteners provided, secure the control panel to the chosen mounting location. Secure the wiring and airlines with the tie-straps provided.

### 16 TESTING THE SYSTEM

Turn the ignition ON, move the left paddle switch to the UP position. The left side needle of the gauge should show air pressure being delivered to the air spring raising the left side of the vehicle.

Then move the left paddle switch to the lower position. The needle of the gauge should show the air pressure dropping and lowering the left side of the vehicle.

Repeat on the right side switch. The right side air spring should raise and lower with movement of the switch.



15

## 17 AIR LEAK CHECK

Inflate both the air springs to 90 PSI. Use a dish soap and water mixture on all airline connections to detect air leaks. Repair as necessary and retest. Inflate the air springs to a predetermined value and then the following day recheck the pressure. If one or both of the air springs have lost pressure, a leak is present. The leak must be repaired and then retest the vehicle until no leaks exist.

***DO NOT EXCEED 100 PSI TO THE AIR SPRINGS AT ANY TIME***



17

## 18 OPERATING YOUR VEHICLE WITH AIR SUSPENSION

Air springs have minimum and maximum pressure requirements. Never operate your vehicle with less than 10 PSI in the air spring and never inflate the air springs over 100 PSI. Damage to the air springs will result.

Check the air pressure in the air springs daily for the first couple of days to ensure a leak does not develop. The air springs are designed to maintain the vehicles stock ride height with a load. Do not use the air springs as a means to lift the vehicle with no load. A rough ride will result.

## 19 SERVICING YOUR VEHICLE WITH AIR SUSPENSION

When lifting the vehicle with a floor jack or hoist on the frame, never allow the air spring to limit the travel of the axle. Try to always jack the vehicle on the axle. Suspending the axle with the air spring limiting the axle travel will damage the air spring and void the air spring warranty.