



# INSTALLATION GUIDE

High Mount Intercooler Kit, Fits 2021+ Ford Bronco 2.3L

SKU: MMINT-BR23-21HK

## TABLE OF CONTENTS

- Pg 1** RESOURCES AND CONTACT INFORMATION
- Pg 2** PARTS BREAKDOWN
- Pg 3** EXPLODED VIEW
  
- Pg 6** IMPORTANT SAFETY INFORMATION
  - SUPPLIED PARTS
  - REQUIRED TOOLS
  - INSTALLATION INSTRUCTIONS
  
- Pg 21** DISPOSAL INSTRUCTIONS
  - WARRANTY INFORMATION

## RESOURCES & CONTACT

-  **CALL 1-877-GOMISHI**  
CUSTOMER SERVICE HOURS: MON-FRI 8:30AM-5:00PM EST
-  **MISHIMOTO**
-  **GOMISHIMOTO**
-  **MISHIMOTO**
-  **WEBSITE**  
[WWW.MISHIMOTO.COM](http://WWW.MISHIMOTO.COM)
-  **ENGINEERING BLOG**  
[WWW.MISHIMOTO.COM/ENGINEERING](http://WWW.MISHIMOTO.COM/ENGINEERING)

**PARTS BREAKDOWN**

PART NUMBER	DESCRIPTION	QTY
Assembly 1	INTERCOOLER ASSEMBLY	1
Assembly 2	INTERCOOLER PIPING ASSEMBLY	1

**PARTS BREAKDOWN - ASSEMBLY 1**

PART NUMBER	DESCRIPTION	QTY
MM9361	INTERCOOLER	1
MM361-03	INTERCOOLER INLET/OUTLET	1
ORC-353-90.5-V-75	O-RING	1
MM1867-01	DUCT 1	1
MM1867-02	DUCT 2	1
MM1867-03	DUCT 3	1
MM1867-04	DUCT 4	1
MM1867-05	DUCT 5	1
MM1867-06	DUCT 6	1
MM2392-01	BRACKET 1	1
MM2392-02	BRACKET 2	1
MM2392-03	BRACKET 3	2
MM2392-04	BRACKET 4	1
MM2392-05	BRACKET 5	1
MM2392-06	BRACKET 6	1
MM2392-07	BRACKET 7	1
MM2392-08	BRACKET 8	1
MM2392-09	BRACKET 9	1
MM2392-10	BRACKET 10	1
MM2392-11	BRACKET 11	1
MM2420-01	ACC BRACKET 1	1
MM2420-02	ACC BRACKET 2	1
MM2420-03	ACC SPACER	3
MM1742	BUSHING	2
MM1281-15	GROMMET	2
HF6X1.0-12A	M6 BOLT, 12MM LENGTH	16
HF6X1.0-12A	M6 BOLT, 14MM LENGTH	3
HF6X1.0-12A	M6 BOLT, 16MM LENGTH	12

**PARTS BREAKDOWN - ASSEMBLY 1**

PART NUMBER	DESCRIPTION	QTY
HF6X1.0-12A	M6 BOLT, 50MM LENGTH	1
HF8X1.25-25A	M8 BOLT, 25MM LENGTH	2
BF6X1.0-16	M6 BUTTON FLANGE BOLT, 16MM LENGTH	3
MM1163-17	LOCKING NUT	4
MM1152-18	WASHER	4
MM1152-40	WASHER	2
MM930	POP CLIP	8
MM1280-11	FOAM, 110MM LENGTH	2
MM1280-11	FOAM, 530MM LENGTH	1
MM1280-12	FOAM, 180MM LENGTH	2
MM1280-12	FOAM, 280MM LENGTH	2
MM1280-14	FOAM, 530MM LENGTH	1
CONNECTOR 1	RADIATOR GRILLE SHUTTER CONNECTOR	1
CONNECTOR 2	INTERCOOLER GRILLE SHUTTER CONNECTOR	1

**PARTS BREAKDOWN - ASSEMBLY 2**

PART NUMBER	DESCRIPTION	QTY
MM2425-01	HOT-SIDE PIPE	1
MM2425-02	COLD-SIDE PIPE	1
MM4623-01	TURBO BOOT	1
MM4623-02	THROTTLE BODY BOOT	1
MM4634-01	INTERCOOLER BOOT	2
MM1533-66	HD WG CLAMP (45-66MM)	1
MM1533-79	HD WG CLAMP (57-79MM)	1
MM1533-92	HD WG CLAMP (70-92MM)	6
MM1281-15	GROMMET	1
BL6x1.0-16	BUTTON HEAD LOCKING BOLT (16MM LONG)	3
HF6X1.0-20A	HEX HEAD FLANGE BOLT (20MM LONG)	1
HF6X1.0-30D	HEX HEAD FLANGE BOLT (30MM LONG)	1
MM1165-07	1/8" NPT PLUG	1

Continued on next page

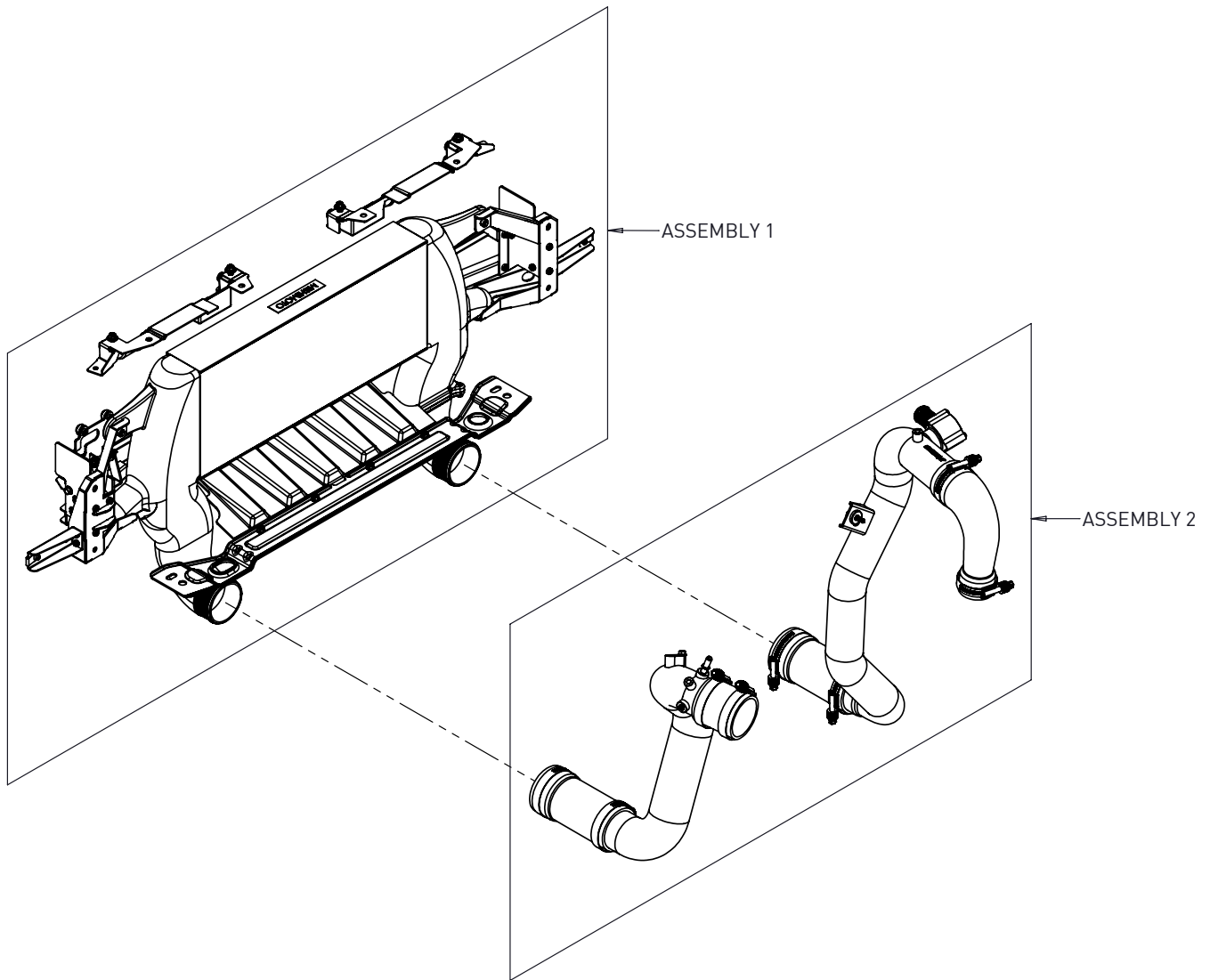

**ASSEMBLY 1**

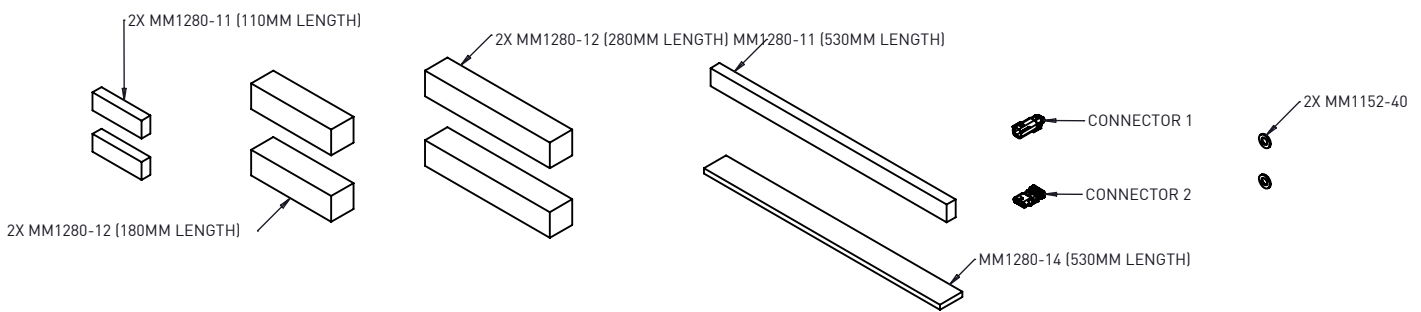

Continued on next page

**ASSEMBLY 1** (CONTINUED)

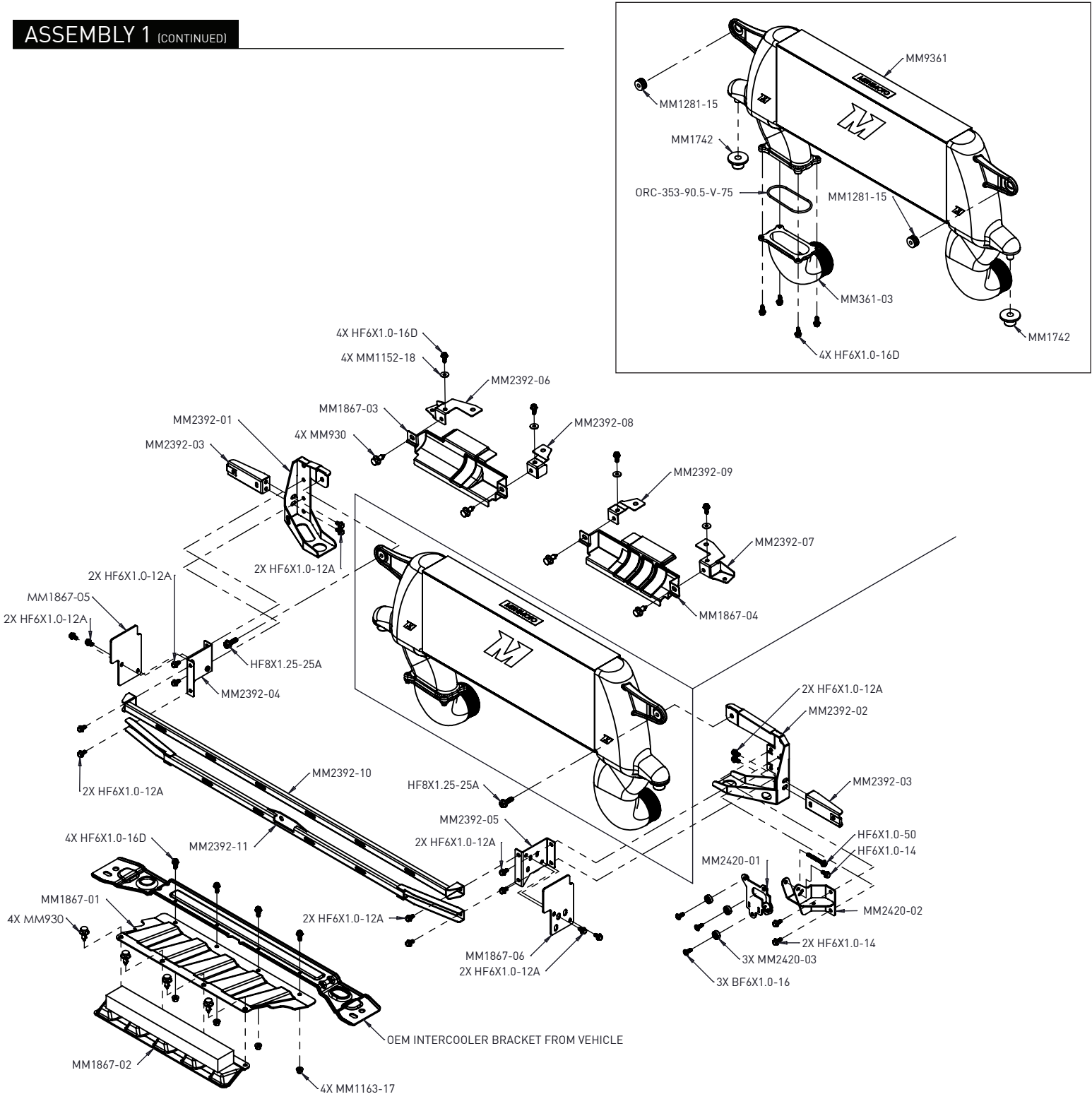

Continued on next page



**ASSEMBLY 2**

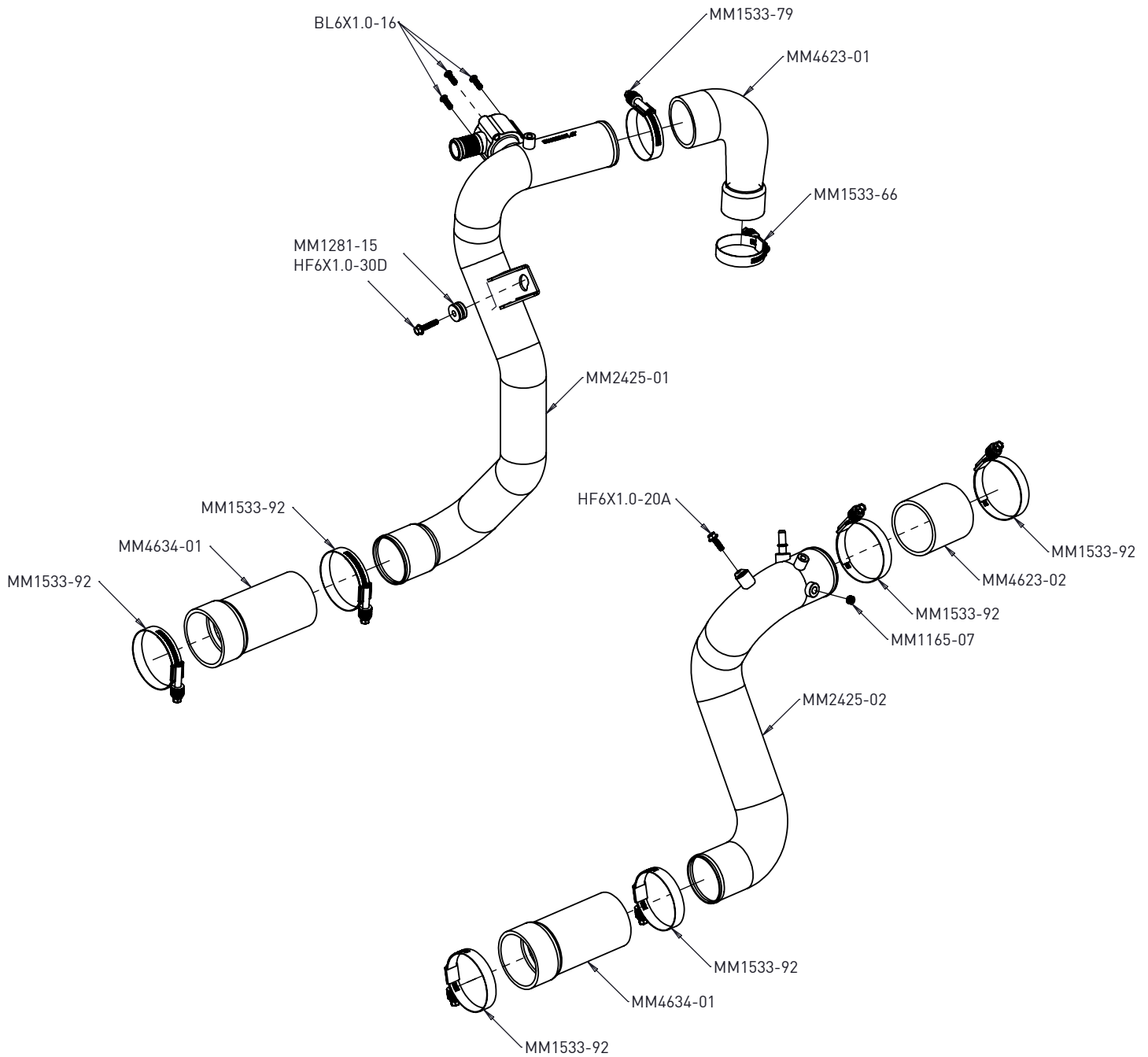

Continued on next page

## IMPORTANT SAFETY INFORMATION

- › Mishimoto recommends you use safety glasses and protective gloves during the installation of our products
- › Raise vehicle only on jack stands or on a vehicle lift
- › Allow vehicle to cool completely prior to attempting installation
- › Do not run the engine or drive the vehicle while overheating; serious damage can occur
- › Please dispose of any liquids properly
- › Mishimoto is not responsible for any vehicle damage or personal injury due to installation errors, misuse, or removal of Mishimoto products
- › If you need any assistance while installing our products, reach out to our Customer Service Team at 1-877-GOMISHI

## REQUIRED TOOLS

1/4" RATCHET AND EXTENSION	HEAT GUN
3/8" RATCHET AND EXTENSION	TAPE MEASURE / DIGITAL CALIPER
1/4" TORQUE WRENCH	CALIPER
7MM SOCKET	MARKER
8MM SOCKET	PAINTERS/MASKING TAPE
10MM SOCKET	CENTER PUNCH
12MM SOCKET	ADHESIVE REMOVER CHEMICAL (GOO-GONE)
15MM SOCKET	DRILL
10MM WRENCH	1/8" DRILL BIT
15MM WRENCH	1/4" DRILL BIT
T30 TORX	3/8" DRILL BIT
4MM ALLEN WRENCH	1/2" DRILL BIT
PANEL TOOL	SANDPAPER
PICK TOOL	COMBINATION SQUARE WITH BUBBLE LEVEL
FLAT HEAD SCREWDRIVER	
PLIERS	

**INSTALL TIME: 8 HOURS**

**INSTALL DIFFICULTY:** 

## INSTALLATION INSTRUCTIONS

- 01.** Measure and record the gap between the fender and the corner marker, do so at both the top and bottom corners of the marker. Do this on both sides. (Painters/masking tape, marker, tape measure or digital caliper)



- 02.** Remove the air duct and radiator cover. (9x pop-clips)

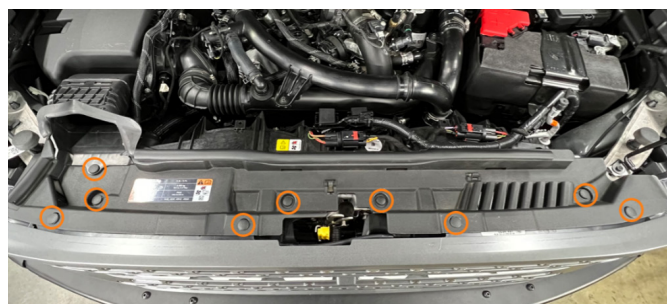

Continued on next page

**03.** Remove the bolts securing the grille to the grille support structure. If equipped, disconnect the electrical harness for the front camera and the fitting for the camera washer. Once the bolts are removed, carefully pull on both sides of the grille to unseat the grille from the grille support structure, then remove the grille from the vehicle. (4x 10mm bolts)

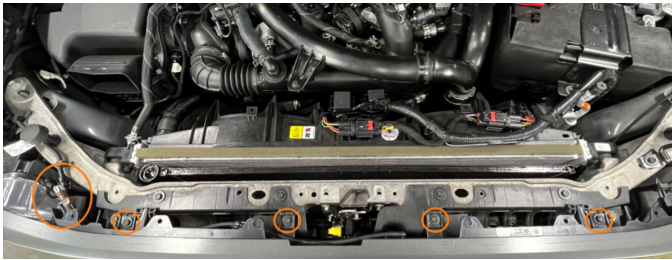

**04.** Locate the front two rotating fasteners securing the fender flares in place and turn them 90 degrees, then pull outward to partially remove them. Do this on both sides.



**05.** Pull outward on the rear corners of the front fascia to unseat it from the clips that secure it to the fenders. Do this on both sides.



**06.** Unseat the front fascia from the clips that secure it to the grille support structure. Once fully unseated, remove the front fascia from the vehicle.

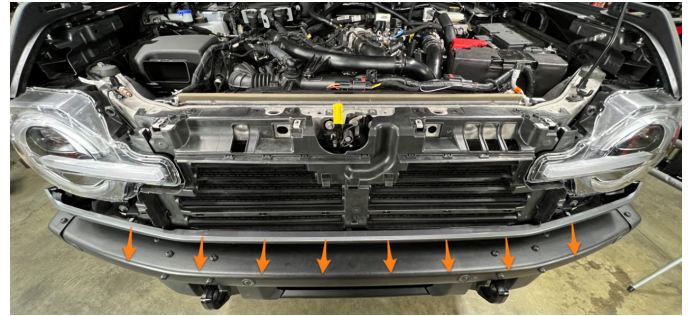

**07.** Disconnect the electrical harness connector that is located below the driver side headlight. (1x harness connector)

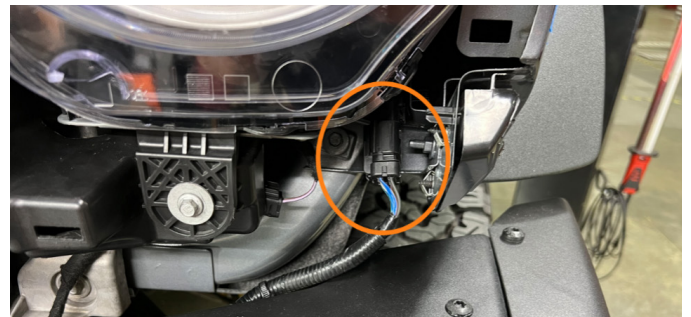

**08.** Remove the pop-clips from the plastic trim panels located on the front bumper (Modular bumper only). Once the pop-clips are removed, pull outward to remove the plastic trim panels from the bumper. (8x pop-clips)

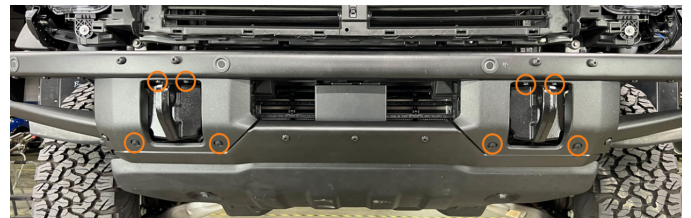

Continued on next page



**09.** Remove the bolts securing the bumper in place, then remove the bumper from the vehicle. **\*Removing the modular bumper may require a second person as it is heavy.** (6x 15mm bolts)



**10.** Disconnect the electrical harness connectors for both the intercooler and radiator active grille shutters. Unseat the intercooler active grille shutter harness tree clip. (2x harness connectors)

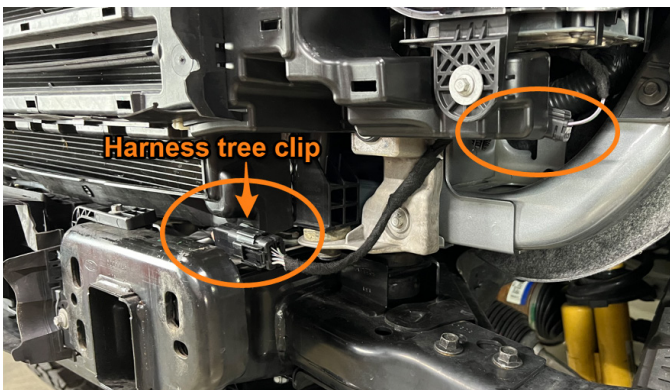

**11.** Remove the intercooler active grille shutter assembly from the vehicle. (4x 8mm bolts)



**12.** Remove the fasteners securing the passenger-side headlight in place. (1x tree clip, 2x 10mm bolts, 1x 8mm bolt) (Image on top right)

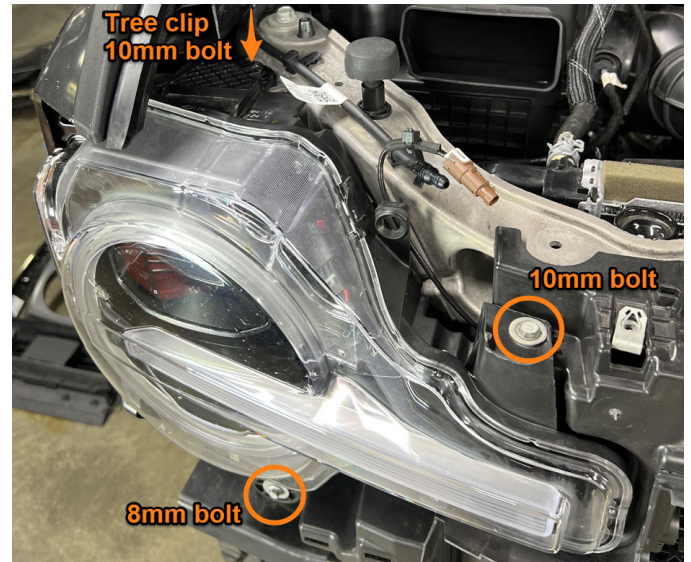

**13.** Using a screwdriver or pick tool, release the barb securing the headlight to the radiator active grille shutter assembly. Once removed, disconnect the electrical harness connector.

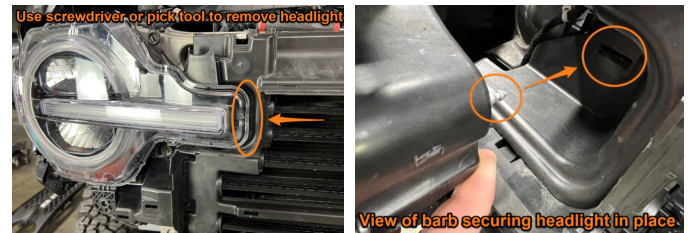

**14.** Repeat steps 12 and 13 to remove the driver-side headlight.

**15.** Remove the fasteners securing the radiator active grille shutter assembly to the radiator support. Once the fasteners are removed, lift upward and outward to unseat and remove the radiator active grille shutter assembly from the vehicle. (8x 10mm bolts)

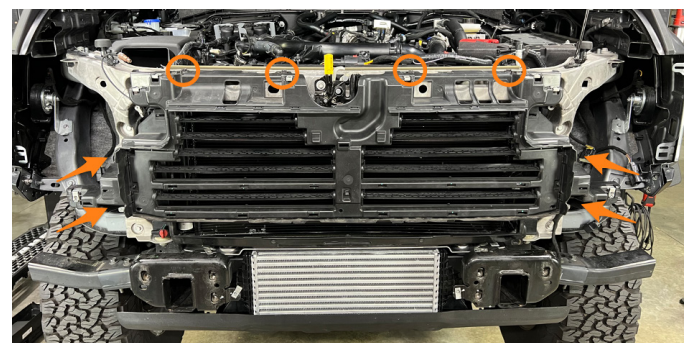

Continued on next page



**16.** Loosen the bolts securing the front skid plate in place then remove only the bolts nearest to the bumper (remove 2x bolts if equipped with modular bumper, 4x bolts if equipped with plastic bumper). Once the bolts are removed, remove the front skid plate from the vehicle. (15mm bolts)

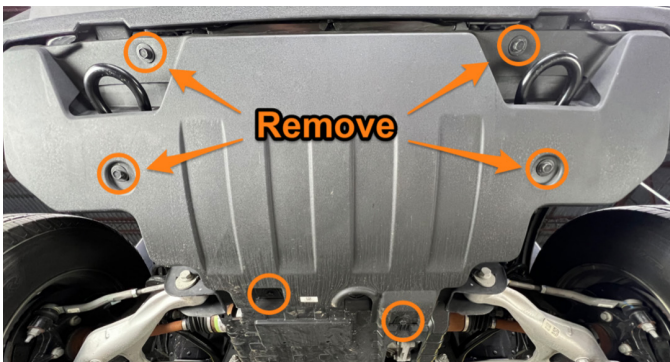

**17.** Remove the lower intercooler brackets. (4x 15mm bolts)

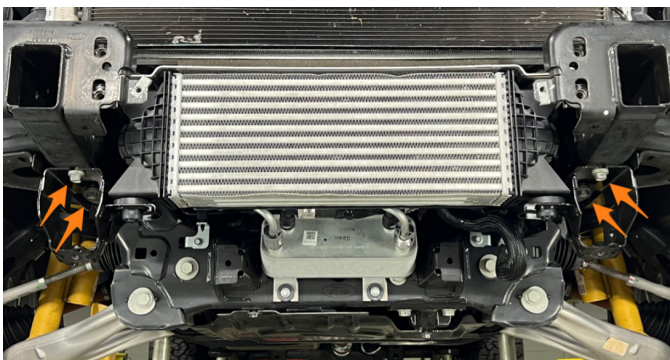

**18.** Disconnect the intercooler inlet and outlet, then remove the intercooler from the vehicle.

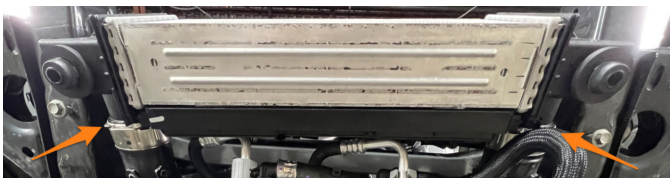

**19.** Disconnect the TMAP sensor electrical harness and vacuum line from the cold-side intercooler pipe.

**20.** Loosen the clamp securing the cold-side intercooler pipe to the throttle body, then remove the cold-side intercooler pipe.

**21.** Remove the bypass valve hose from the bypass valve.

**22.** Disconnect the bypass valve electrical harness.

**23.** Loosen the clamp securing the hot-side intercooler pipe to the turbo.

**24.** Disconnect the two vacuum lines attached to the air intake tube.

**25.** Remove the 8mm bolt securing the hot-side intercooler pipe to the bracket on the front of the engine, then remove the hot-side intercooler pipe.

**26.** Transfer the TMAP sensor from the stock cold-side intercooler pipe to the Mishimoto cold-side intercooler pipe and secure it in place using the provided hardware. (Flange-Head M6X1.0-20)

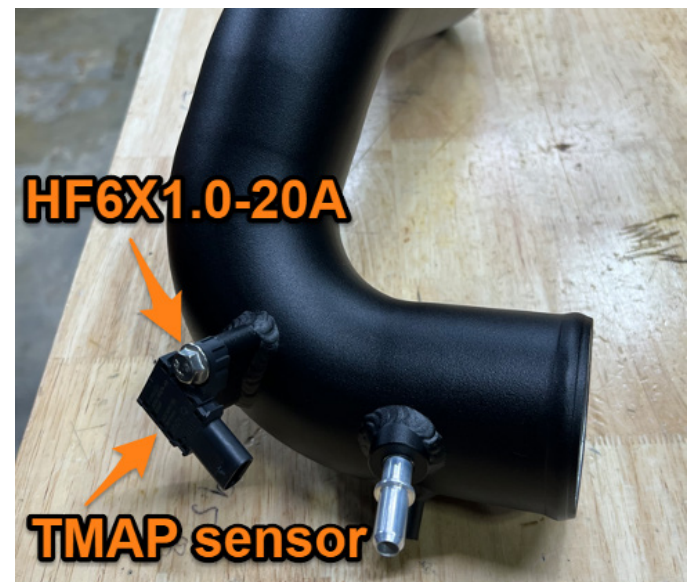

Continued on next page



**27.** Transfer the bypass valve from the stock hot-side intercooler pipe to the Mishimoto hot-side intercooler pipe and secure it in place using the provided hardware. (3x Button-Head M6X1.0-16)



**28.** Install the provided grommet onto the Mishimoto hot-side intercooler pipe. (MM1281-15)



**29.** Using the provided clamps and turbo boot, install the Mishimoto hot-side intercooler pipe. Do not tighten the clamps, this will be done later. Reconnect the bypass valve hose and electrical harness. (MM4623-01, MM1533-66, and MM1533-79)

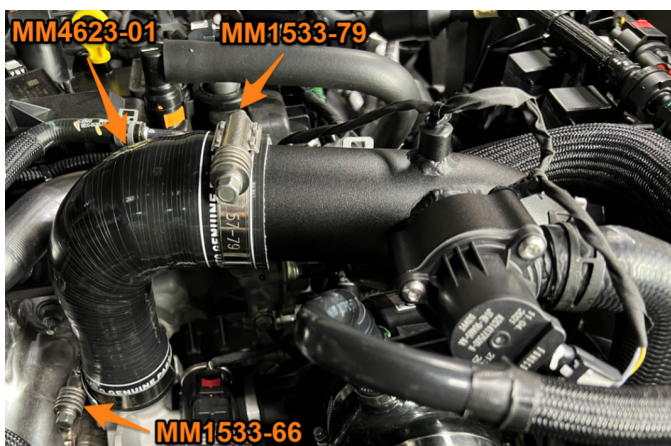

**30.** Secure the Mishimoto hot-side intercooler pipe to the bracket on the front of the engine using the provided hardware. (Flange-Head M6X1.0-30)

**31.** Reconnect the two vacuum lines to the air intake tube.

**32.** Using the provided clamps and throttle body boot, install the Mishimoto cold-side intercooler pipe. Do not tighten the clamps, this will be done later. Reconnect the TMAP sensor electrical harness and vacuum line. (MM4623-02 and 2x MM1533-92)

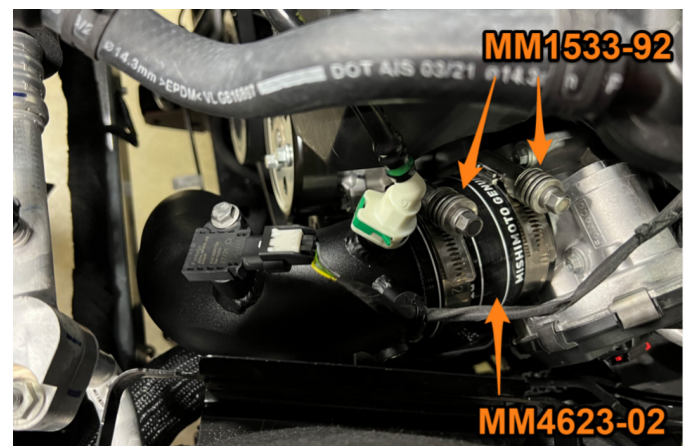

**33.** Remove the upper intercooler bracket from the vehicle. (2x 15mm bolts)

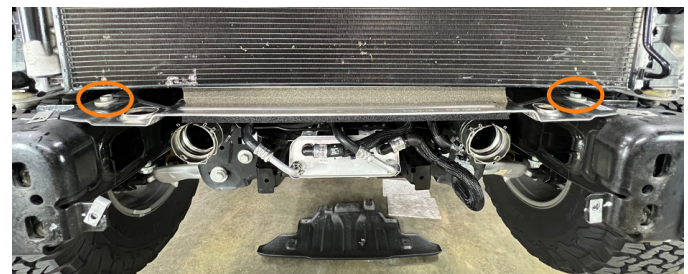

**34.** Remove the large adhesive backed foam strip from the upper intercooler bracket using a heat gun. Once removed, clean off any residual adhesive from the bracket. (Images on next page)

Continued on next page



**35.** Mark the locations where holes need to be drilled in the upper intercooler bracket using the above drawing. Once marked, center punch each hole location. Drill a pilot hole at each hole location using a 1/8" drill bit. Use a 1/4" (6.35mm) drill bit to open up all the pilot holes to 1/4". Using a 1/2" (12.7mm) drill bit, open up the two outer most mounting holes to 1/2".

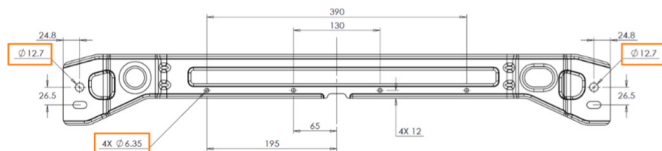

**36.** Remove any burrs created during the drilling process with sand paper.



**37.** Fasten the MM1867-01 duct to the upper intercooler bracket using the provided hardware. (4x HF6x1.0-16D and 4x MM1163-07) (Image on top right)



**38.** Apply the 530mm long pieces of MM1280-11 and MM1280-04 adhesive backed foam to the upper intercooler bracket and ducting assembly.



**39.** Slide the upper intercooler bracket, ducting, and foam assembly back into the vehicle between the frame and the radiator until the ducting is touching, or close to touching, the A/C condenser. This bracket assembly will be fully installed in a later step.



**40.** Apply the two 280mm long pieces of MM1280-12 adhesive backed foam to the radiator support, between the radiator and radiator support. (Additional images on next page)

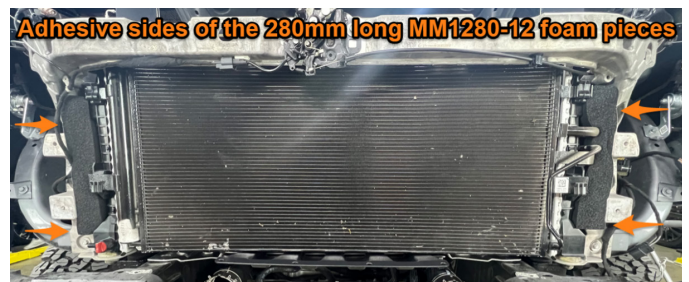

Continued on next page





**41.** Apply the two 110mm long pieces of MM1280-11 adhesive backed foam to the back sides of MM2392-01 and MM2392-02 in the locations shown. [2x 110mm long MM1280-11]

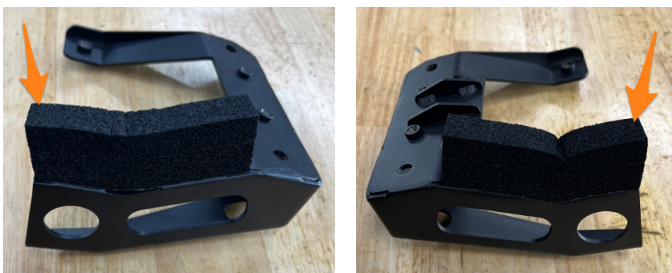

**42.** Loosely install MM2392-01 and MM2392-02 with one bolt only.



**43.** Remove the 4x 10mm bolts securing the lower section of the passenger-side intercooler end tank in place, then remove the lower section of the end tank from the intercooler. (Image on top right)

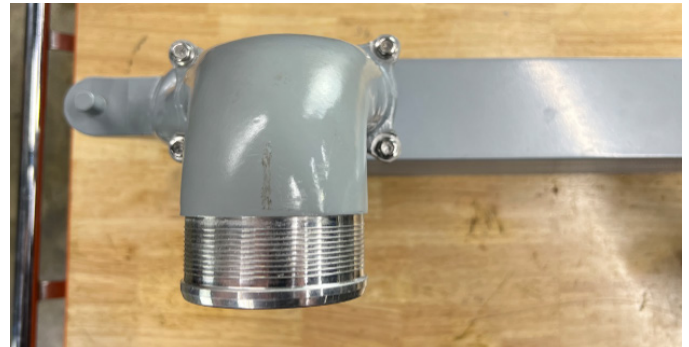

**44.** Install the provided grommets and bushings on to the intercooler. [2x MM1281-15 and 2x MM1742]



**45.** Maneuver the driver-side of the intercooler between the frame and ducting, then lower the passenger-side of the intercooler down between the frame and A/C condenser. Once the intercooler is in its approximate location, rotate the brackets into position and lower the intercooler into the brackets.



Continued on next page



**46.** Install the remaining bolts to secure the intercooler brackets to the vehicle, then tighten them. [2x 10mm bolts]

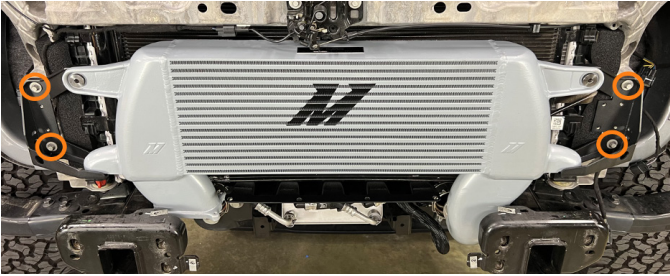

**47.** Secure the intercooler to the brackets using the provided 12mm bolts. [2x HF8X1.25-25A]



**48.** Pull outward on the upper intercooler mounting bracket, ducting, and foam assembly until the 1/2" mounting holes align with the threaded holes in the frame. Once aligned, use the original fasteners to secure it in place. [2x 15mm bolts]

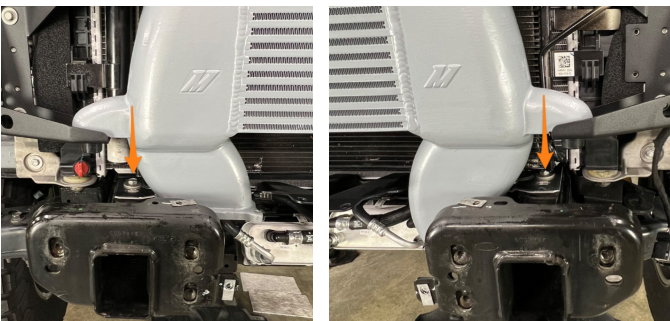

**49.** Install 2x MM2392-03 using the provided 12mm length bolts. Do not fully tighten the bolts as the brackets' final position will be adjusted in a later step. [4x HF6X1.0-12A]



**50.** Install MM2392-06, -07, -08, and -09 using the original fasteners that were used to secure the radiator grille shutter assembly in place. [4x 10mm bolts]

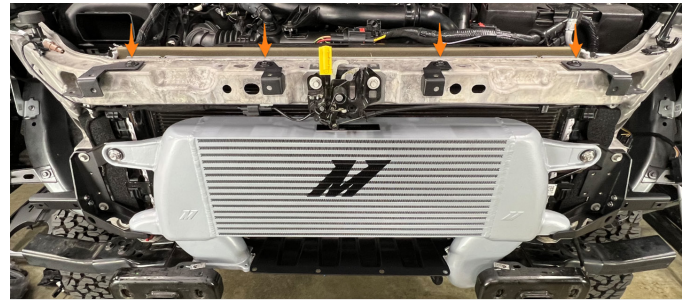

**51.** Install MM1867-03 and -04 to the brackets previously installed in step 35 using the provided pop clips. [4x MM930]

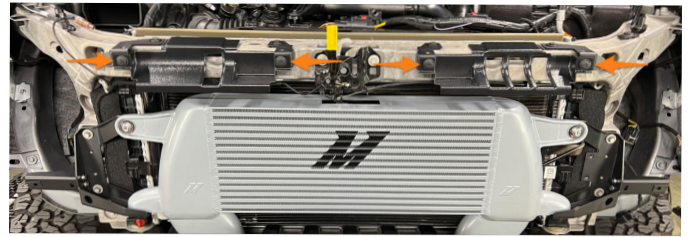

**52.** If your vehicle is equipped with the modular bumper, fasten MM1867-02 to the upper intercooler bracket, ducting, and foam assembly using the provided pop clips. [4x MM930]. **\*Proceed to step 53 if your vehicle is not equipped with the modular bumper.**

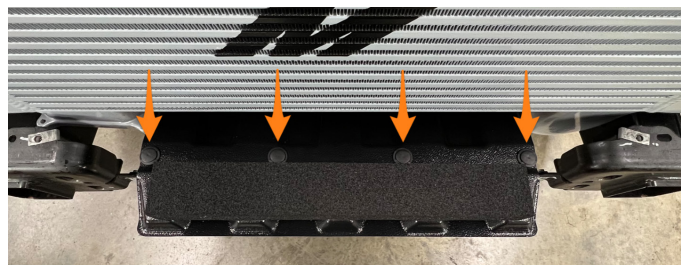

Continued on next page



**53.** Install the headlights. Adjust the positioning of the headlights until the gap measured in step 1 is achieved then tighten all the fasteners, including the fasteners securing the MM2392-03 brackets in place. After tightening, check the measurement again to confirm it has not changed. Once confirmed, remove the headlights from the vehicle.

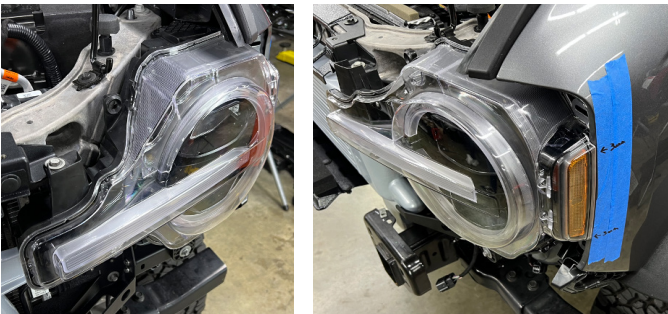

**54.** Carefully remove the wiring harness from the intercooler grille shutter assembly.



**55.** Push the provided cavity plugs into the open cavities located on the back side of the provided intercooler grille shutter motor connector.



**56.** Connect the provided intercooler grille shutter motor connector to the corresponding connector on the intercooler grille shutter wire harness. **\*If your vehicle is not equipped with Active Cruise Control, please proceed to step 66.**



**57.** Pull outward on the cover located on the front of the intercooler grille shutter assembly to remove it.



**58.** Using a panel tool, carefully pry upward on the bottom of the 3x active cruise control sensor brackets to remove it from the intercooler grille shutter assembly. **You MUST be very careful not to drop this sensor as it can be damaged very easily.**

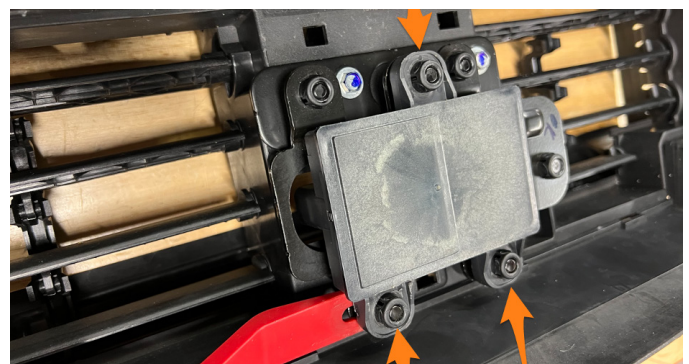

Continued on next page



**59.** Remove the 3x plastic bushings from the sensor by pushing the tabs inward while applying some downward pressure, then push the bushings out of the sensor brackets.

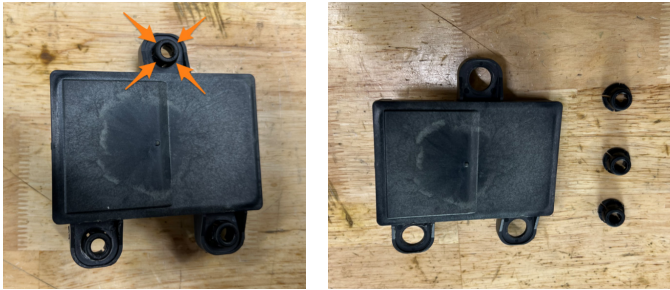

**60.** Fasten the adaptive cruise control sensor to the MM2420-01 bracket using the provided hardware and spacers. [3x BF6X1.0-16 and 3x MM2420-03 spacers]

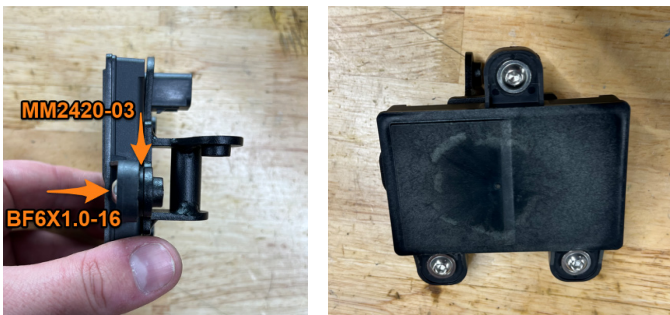

**61.** Install the MM2420-02 bracket to the driver-side intercooler mounting bracket using the provided hardware. [2x HF6X1.0-14]

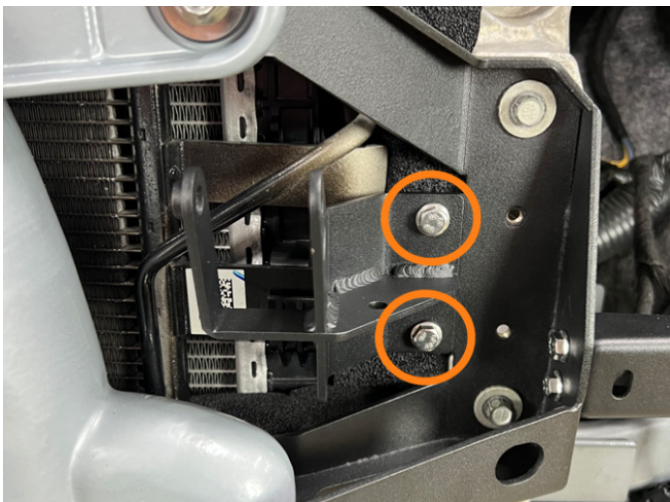

**62.** Fasten the MM2420-01 bracket and sensor assembly to the MM2420-02 bracket using the provided hardware. [1x HF6X1.0-14 and 1x HF6X1.0-50]



**63.** Using a square with a bubble level, adjust the sensor pivot angle until it is level. Once the sensor is level, tighten the bolts.



**64.** Using a square with a bubble level, adjust the MM2420-02 bracket until level. Once level, tighten the bolts.



Continued on next page



**65.** Connect the intercooler grille shutter harness to the adaptive cruise control sensor, then attach the harness tree clip to the open hole on the MM2420-02 bracket.

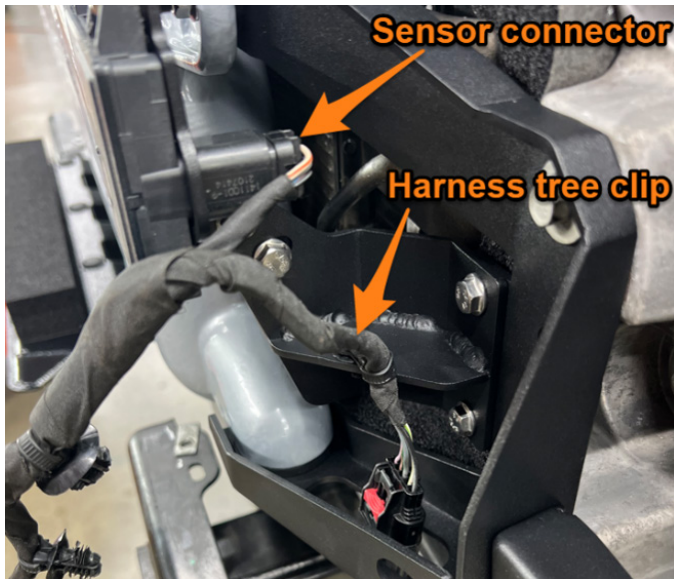

**66.** Secure the intercooler grille shutter harness to the MM2392-05 bracket using the harness tree clips. Route the harness as shown above.



**67.** Attach the MM1867-06 duct panel to the MM2392-05 bracket using the provided hardware. [2x HF6X1.0-12A]



**68.** Install the MM2392-05 bracket to the driver-side intercooler bracket using the provided hardware. Reconnect the intercooler grille shutter harness to the vehicle body harness and attach the connector tree clip to the MM2392-03 bracket as shown in the above image. [2x HF6X1.0-12A] **\*If your vehicle is equipped with Active Cruise Control, skip 69.**



Continued on next page

**69.** Route the remaining harness section with the provided intercooler grille shutter motor connector over top of the MM1867-06 duct panel and let the connector rest in the bottom of the intercooler bracket.



**70.** Unseat the connector from the driver-side of the radiator grille shutter assembly.

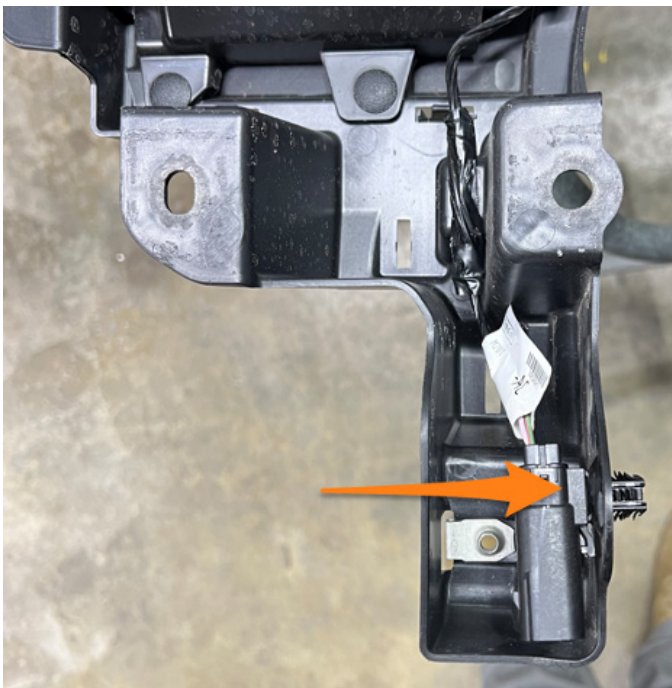

**71.** Remove the connector tree clip from the connector using a panel tool or flat head screwdriver.

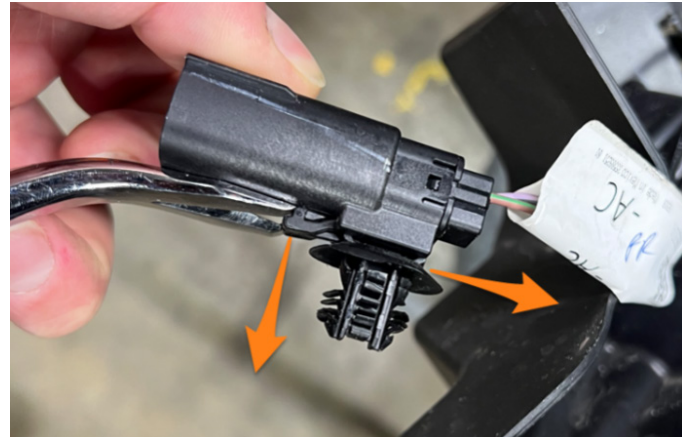

**72.** Install the connector tree clip onto the provided radiator grille shutter motor connector.



**73.** Connect the provided radiator grille shutter motor connector to the vehicle body harness.

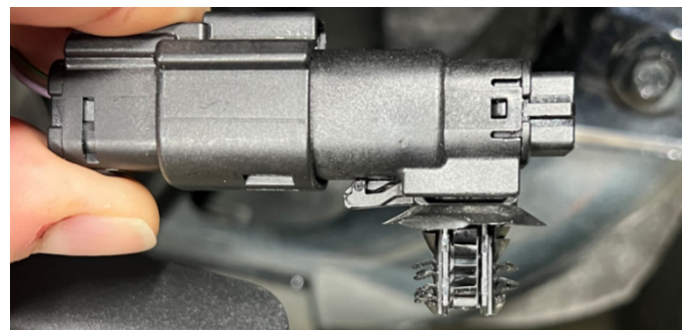

Continued on next page



**74.** Secure the radiator grille shutter motor connector to the body of the vehicle in the location shown above.

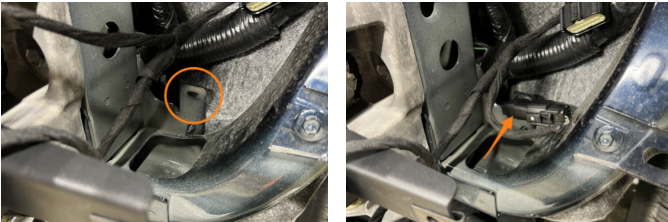

**75.** Fasten the MM1867-05 duct panel to the MM2392-04 bracket using the provided hardware. (2x HF6X1.0-12A)



**76.** Install the MM2392-04 bracket to the passenger-side intercooler bracket using the provided hardware. (2x HF6X1.0-12A)

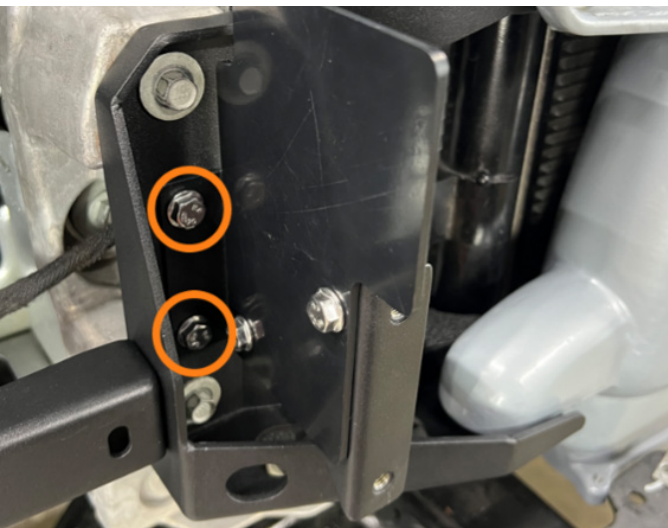

**77.** Install the MM2392-11 bracket to the MM2392-04 and -05 brackets using the provided hardware. Align the bottom of the brackets, then tighten the bolts. (2x HF6X1.0-12A)

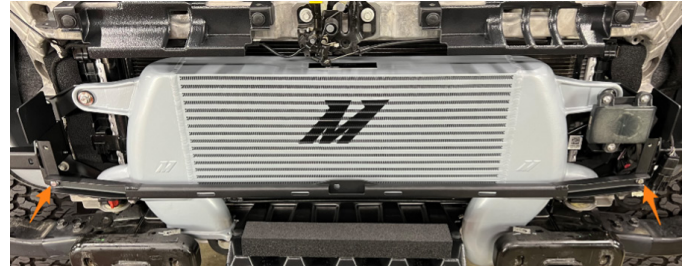

**78.** Install the MM2392-10 bracket to the MM2392-04 and -05 brackets using the provided hardware. Align the top of the brackets, then tighten the bolts. (2x HF6X1.0-12A)



Continued on next page



**79.** Clean off any debris that may have made its way into the o-ring then reinstall the lower section of the passenger-side end tank. Torque the bolts to 10 Nm (88.5 in-lbs).

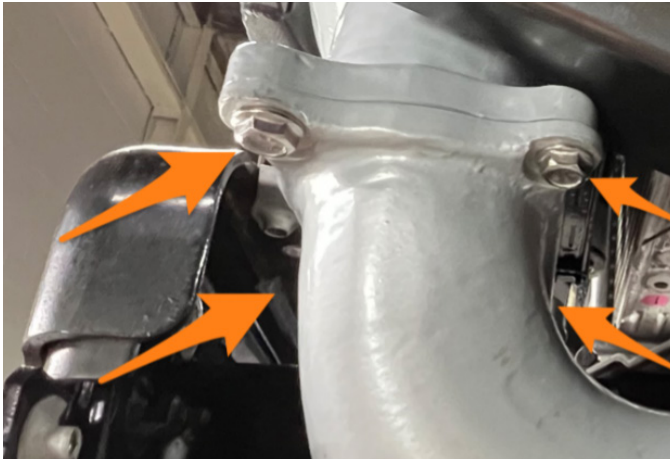

**80.** Assemble the provided adapters and couplers with the provided clamps. (2x MM1853-01, 2x MM4618-01, and 2x MM1533-92)

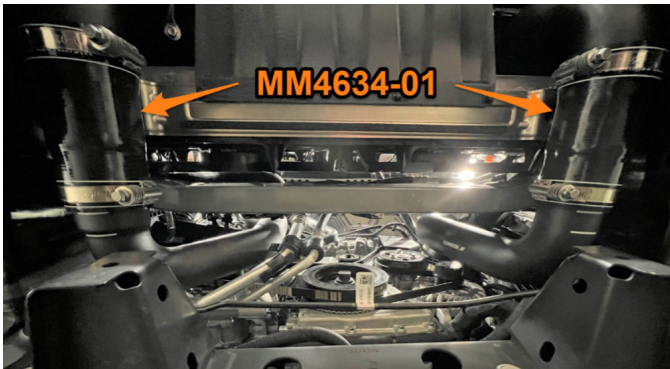

**81.** Check to make sure the Mishimoto intercooler piping is not touching any of the pulleys on the front of the engine. Once proper clearance around the piping is confirmed, tighten all the clamps.

**82.** Apply the two 180mm long pieces of MM1280-12 adhesive backed foam to the areas shown in the above images. Adhere the foam to the radiator support and A/C condenser end tanks.

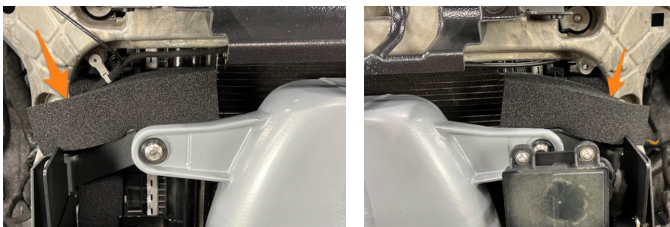

**83.** Reinstall the headlights.

**84.** Cut the alignment peg on the back side of the front fascia to approximately 3/4" length (20mm) using a pair of pliers.



**85.** Reinstall the front fascia.



**86.** Reinstall the fender flares.



Continued on next page



**87.** Reinstall the grille using the provided bolts and washers. If equipped, reconnect the front camera harness and camera washer fitting. (4x HF6X1.0-16D and 4x MM1152-18)

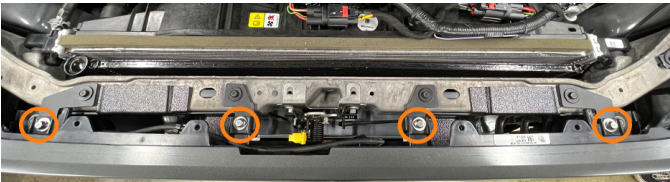

**88.** Reinstall the radiator cover.



**89.** Reinstall the stock intercooler lower mounting brackets.



**90.** Reinstall the front skid plate. (Image on right)

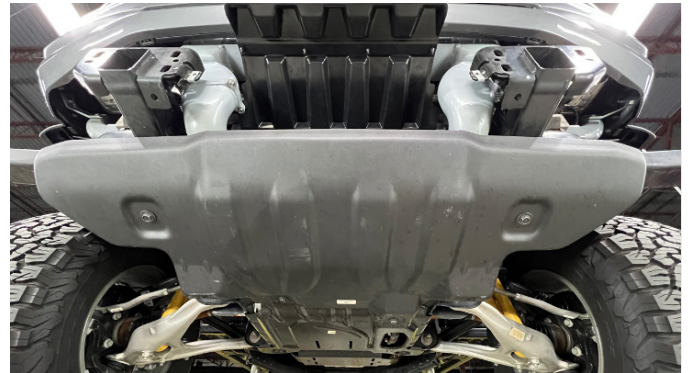

**91.** Guide the front bumper back onto the vehicle, ensuring that the lower intercooler ducting slides into the upper area of the bumper.



**92.** Secure the front bumper in place with the original fasteners. Use the provided larger washers under the upper two inboard fasteners. This increases the clearance between the back side of the fastener and the intercooler end tanks. (2x MM1152-40)



**93.** Reinstall the front bumper plastic trim panels.

**Congratulations! You have finished your installation!**

Continued on next page

## DISPOSAL INSTRUCTIONS

- › Do not dispose of any product as unsorted municipal waste. Use separate collection facilities. Contact your local authority for information regarding the collection systems available.
- › Never improperly dispose of any coolant, oil, or other chemicals.

## WARRANTY INFORMATION



- › All claims must be accompanied with a picture of the Mishimoto product showing the issue for which the claim is being submitted.
- › Mishimoto asks that the customer inspect their purchased item for any damage immediately upon arrival.
- › Any product deemed dead on arrival (DOA) must be claimed within 14 business days of delivery. Claims outside of this time frame will not be covered under the Mishimoto Lifetime Warranty.
- › This warranty does not include payment and/or reimbursement of the cost of labor in connection with the removal of any product returned pursuant to the warranty policy or in connection with the installation of any replacement items provided under the warranty policy.
- › Mishimoto has the right to refuse a claim at any time.

- › When Mishimoto accepts a claim, Mishimoto retains full discretion to choose if it will: (i) repair or replace purchaser's original Mishimoto product; (ii) replace purchaser's original Mishimoto product with the most current available model; or (iii) provide the purchaser with a gift card redeemable on [Mishimoto.com](https://www.mishimoto.com) in the amount of the original purchase price of the original Mishimoto product. The provision of a replacement of a Mishimoto product is subject to availability and Mishimoto retains the right to substitute any warranty claim item with a comparable item or credit at any time.
- › If Mishimoto determines that it will provide a replacement item in connection with a claim under this warranty policy, and such item is out of stock, Mishimoto will place the customer on backorder and ship the replacement product to the purchaser once it becomes available.
- › Mishimoto is not liable for incorrect shipments in connection with a claim if a claim form is completed incorrectly, or if a model number is not included in a claim.
- › If you have a vehicle equipped with an automatic transmission, please make sure to specify this within the text box on the claim form. Mishimoto is not responsible for incorrect replacement shipments if transmission type is not indicated.



**WARNING**  
Cancer and  
Reproductive Harm  
[www.P65Warnings.ca.gov](https://www.P65Warnings.ca.gov)

This product can expose you to chemicals which are known to the state of California to cause cancer. For more information visit: [www.p65warnings.ca.gov](https://www.p65warnings.ca.gov)