

# BORNE OFF-ROAD



## INSTALLATION GUIDE

Direct-Fit Pod Lights, Fits 2021+Ford Bronco w/ Standard Bumper  
SKU: BNLT-BR-21S-B6

### TABLE OF CONTENTS

1. RESOURCES & CONTACT INFO
2. EXPLODED VIEW
3. IMPORTANT SAFETY INFORMATION
  - REQUIRED TOOLS
  - INSTALL TIME & DIFFICULTY
  - INSTALLATION INSTRUCTIONS
13. DISPOSAL & WARRANTY INFORMATION

### RESOURCES & CONTACT



**CALL 1.877.466.4744**

CUSTOMER SERVICE HOURS: MON-FRI 9:00AM-7:00PM EST



**@BORNEOFFROAD**



**@BORNEOFF-ROAD**



**BORNEOFFROAD**



**@BORNEOFFROAD**



**ENGINEERING BLOG**

[WWW.BORNE.COM/ENGINEERING](http://WWW.BORNE.COM/ENGINEERING)

### PARTS BREAKDOWN

PART NUMBER	DESCRIPTION	QTY	PART NUMBER	DESCRIPTION	QTY
MM10090-33S	POD LIGHT - SPOT BEAM	2	MM1649-02	M6 FASTENER CAP	12
MM10090-33F	POD LIGHT - FLOOD BEAM	4	H8X1.25-25	M8 HEX BOLT	6
MM2501-33.1	LIGHT BRACKET	6	MM1163-33	M8 LOCK NUT	6
MM2532	TUBE	1	B8X1.25-12	M8 BUTTON HEAD BOLT	4
MM2533-01	BRACKET 1	1	MM1649-03	M8 FASTENER CAP	4
MM2533-02	BRACKET 2	1	MM2501-02	HARNESS ADAPTER (NOT SHOWN)	2
B6X1.0-14	M6 BUTTON HEAD BOLT	12	MM10083	WIRE HARNESS (NOT SHOWN)	2
MM1174-26	M6 LOCKWASHER	12	MM1164-01	ZIP-TIE (NOT SHOWN)	12

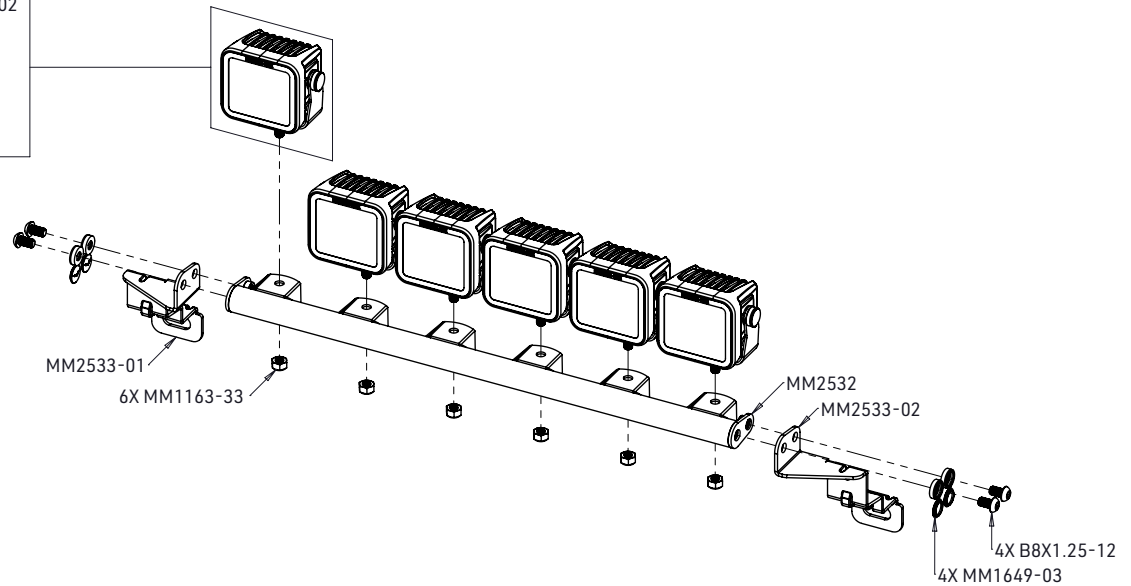
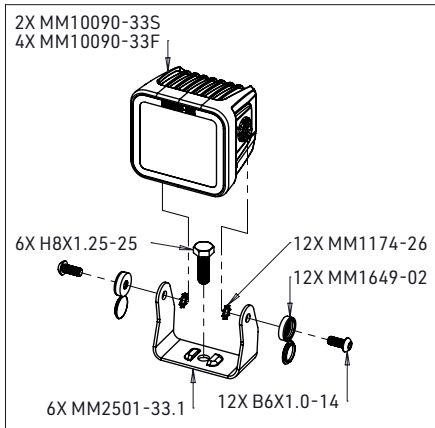

FOR QUESTIONS OR ASSISTANCE WITH YOUR BORNE OFF-ROAD PRODUCT, CONTACT US AT 1.877.466.4744 OR VISIT BORNE.COM

Continued on next page

### IMPORTANT SAFETY INFORMATION

- ▶ Borne Off-Road recommends you use safety glasses and protective gloves during the installation of our products
- ▶ Raise vehicle only on jack stands or on a vehicle lift
- ▶ Allow vehicle to cool completely prior to attempting installation
- ▶ Borne Off-Road is not responsible for any vehicle damage or personal injury due to installation errors, misuse, or removal of Borne Off-Road products
- ▶ If you need any assistance while installing our products, reach out to our Customer Service Team at 1-877-466-4744

### REQUIRED TOOLS

PANEL TOOL	1/2" RATCHET AND EXTENSION
PAINTERS/MASKING TAPE	8MM SOCKET
ELECTRICAL TAPE	10MM SOCKET
METAL ROD	13MM SOCKET
WIRE STRIPPER	15MM SOCKET
DEUTSCH CLOSED BARREL TERMINAL CRIMP TOOL (FOR SIZE 12 TERMINAL)	1/2" TORQUE WRENCH
DEUTSCH CLOSED BARREL TERMINAL CRIMP TOOL (FOR SIZE 16 TERMINAL)	4MM ALLEN WRENCH
	5MM ALLEN WRENCH
	SIDE CUTTERS
	LEVEL
1/4" RATCHET AND EXTENSION	

**INSTALL TIME: 3.5 HOURS**

**INSTALL DIFFICULTY:** 

### INSTALLATION INSTRUCTIONS

1. Remove the radiator cover. (9 pop clips)



2. Remove the bolts securing the grill to the grill support structure. (4x 10mm bolts)



3. If equipped, disconnect the electrical harness for the front camera and the fitting for the camera washer.



Continued on next page

**4.** Locate the front three rotating fasteners securing the fender flares in place and turn them 90 degrees, then pull outward to partially remove them. Do this on both sides.



**5.** Apply masking tape to the front sections of both fenders as shown in the images below.



**6.** Carefully pull on both sides of the grill to unseat the grill from the grill support structure, then remove the grill from the vehicle.

**7.** Pull outward on the rear corners of the front fascia to unseat it from the clips that secure it to the fenders. Do this on both sides.

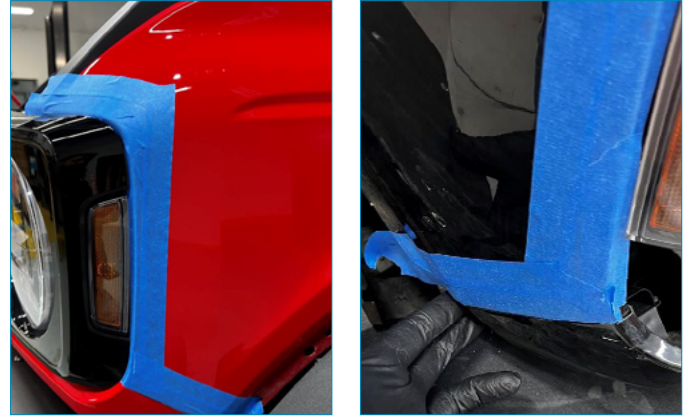

**8.** Unseat the front fascia from the clips that secure it to the grill support structure. Once fully unseated, remove the front fascia from the vehicle.



If installing the light kit compatible with the factory Upfitter switches, proceed to step 9. If installing a light kit using the non-Upfitter wiring harness, proceed to step 16.

Continued on next page

9. The Upfitter auxiliary wires are located on the driver's side of the vehicle next to the brake booster. Locate the green with brown stripe wire (Aux 2) and trim the cap off the end. Once trimmed, strip approximately ¼" of insulation off the wire. Once stripped, carefully insert the wire into the provided size #12 female closed barrel terminal, ensuring all strands make it into the terminal, then crimp it in place. This green with brown stripe wire corresponds to the auxiliary 2 Upfitter switch. The two pairs of flood beam pod lights draw approximately 13.5 amps at 12VDC, which means they must be connected to the auxiliary 1 or 2 circuits. An additional auxiliary circuit will be needed for the pair of spot beam pod lights. Any one of the remaining circuits can be used for the pair of spot beam pod lights. For this install guide, we chose auxiliary 3 (violet with green stripe wire). Trim the cap off the end of the additional upfitter auxiliary wire, then strip approximately ¼" of insulation. Once stripped, carefully insert the wire into the provided size #16 female closed barrel terminal, ensuring all strands make it into the terminal, then crimp it in place. (1x size #12 female closed barrel terminal and 1x size #16 female closed barrel terminal)



10. Insert the green with brown stripe wire into position 2 of the provided large-sized male wire harness connector. A clicking sound will indicate that the terminal has been pressed far enough to engage with the locking tab inside the connector. Perform a visual inspection of the terminals from the front side of the connector. Ensure the locking rim of each terminal rests on the locking tab inside the connector. Once confirmed, insert the provided locking wedge into the center of the fitting. The wedge will be fully seated when it sits flush with the face of the connector. (1x locking wedge)

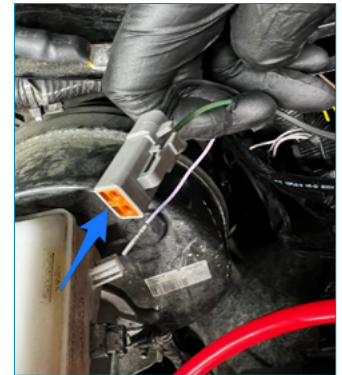
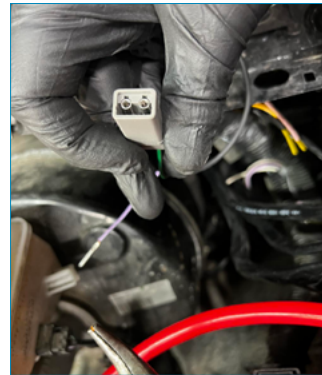

11. Insert the violet with green stripe wire into position 2 of the provided small-sized male wire harness connector. A clicking sound will indicate that the terminal has been pressed far enough to engage with the locking tab inside the connector. Perform a visual inspection of the terminals from the front side of the connector. Ensure the locking rim of each terminal rests on the locking tab inside the connector. Once confirmed, insert the provided locking wedge into the center of the fitting. The wedge will be fully seated when it sits flush with the face of the connector. (1x locking wedge)

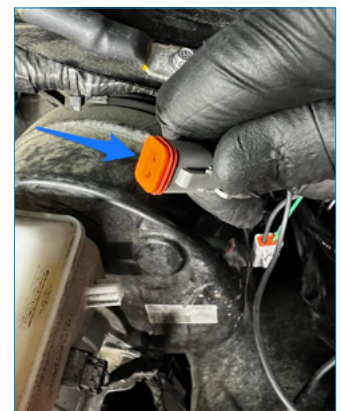

Continued on next page

**12.** Secure the ground ring terminals to the chassis ground located above the brake booster. (1x 8mm Bolt)



**13.** Connect the direct-fit wire harnesses to the connectors.

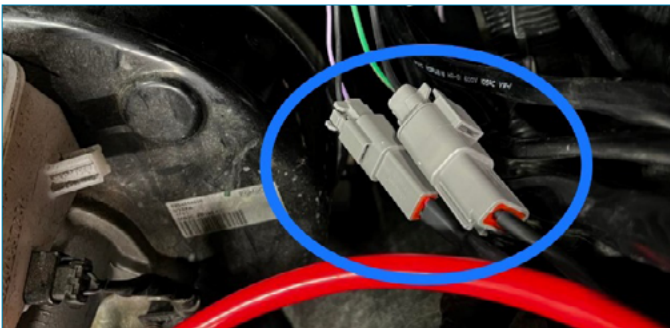

**14.** Route the harnesses along the driver's side fender and down between the radiator and radiator support structure.

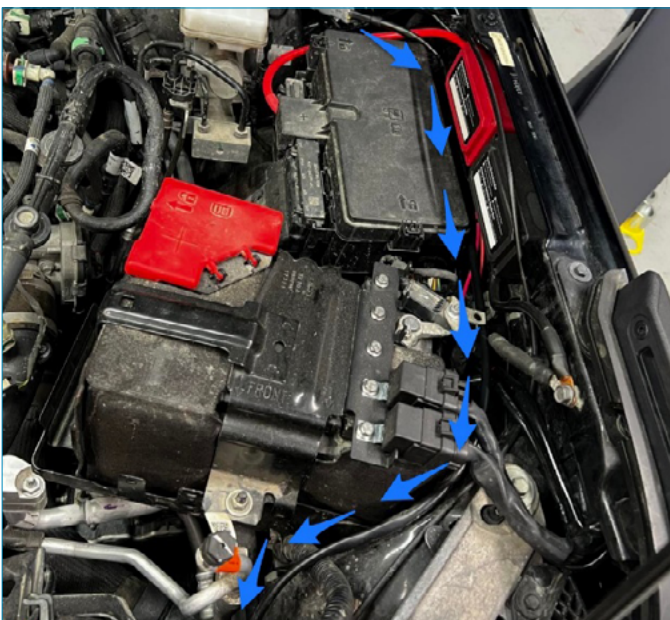

**15.** Once the connectors on the ends of the wire harnesses make it past the bottom of the grill support structure, carefully pull on the wire harnesses until the slack in the engine bay is removed. Proceed to step 26.



**16.** Remove the three female spade terminals from the two-position pod light switches. The female spade terminals have a locking feature that must be depressed to unlock them from the blades on the back side of the switch.



Continued on next page

**17.** Tape the switch harnesses to a metal rod. Feed the harnesses inside the driver-side fender from the battery back to the cowl.

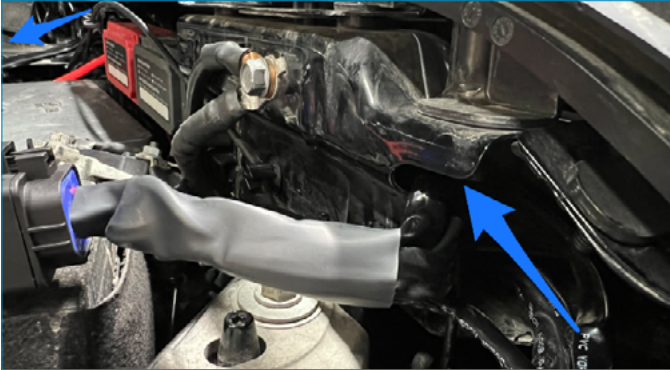

**18.** Feed the switch wiring harnesses through the driver's side of the firewall. For this installation, we drilled a hole in the rubber plug next to the brake booster to pass the wires through

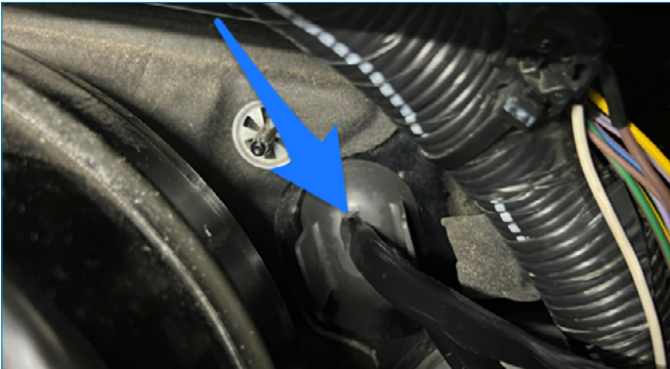

**19.** Pull the remaining length of the switch wire harnesses through the firewall, then route the wiring to the desired switch mounting location. For this installation, we used the Borne Off-Road Bronco Direct-Fit Switch Panel, which mounts above the center console.



**20.** Feed the wires through the switch holes, then reconnect them to the switches, as shown in the diagram below. Once the wires are reconnected, install the switches into the mounting holes.

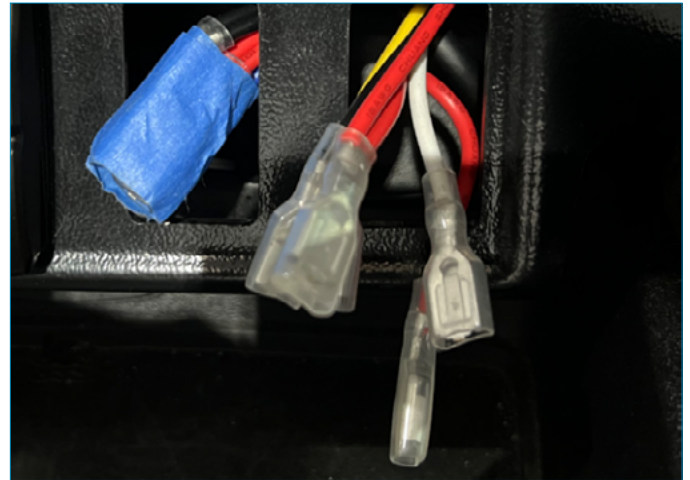

### 2 POSITION SWITCH: ON - OFF

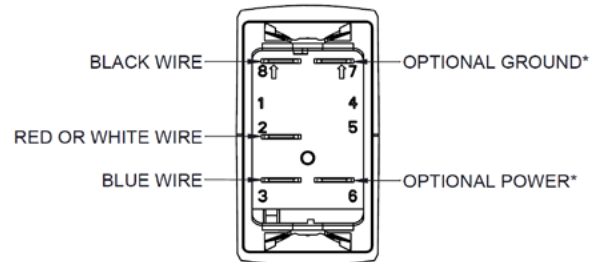

\*TO ILLUMINATE BOTTOM HALF OF SWITCH. WIRING NOT INCLUDED.

**21.** Secure all loose wiring under the dashboard and driver-side footwell. The wires must be secured out of the way of the pedals, steering column, and any other moving components.

**22.** Find a suitable location to mount the wire harness relay. For this installation, we used our Borne Off-Road Bronco Direct-Fit Battery Relay Holder. Repeat this step for both wire harnesses.



Continued on next page

**23.** Connect the positive wire from the harness to a suitable power distribution point on the vehicle (this could be the battery if no other option is available). Connect the wire harness ground wire to a suitable chassis ground. For this installation, we used our Borne Off-Road Bronco Direct Fit Bus Bar Kit. Repeat this step for both wire harnesses.

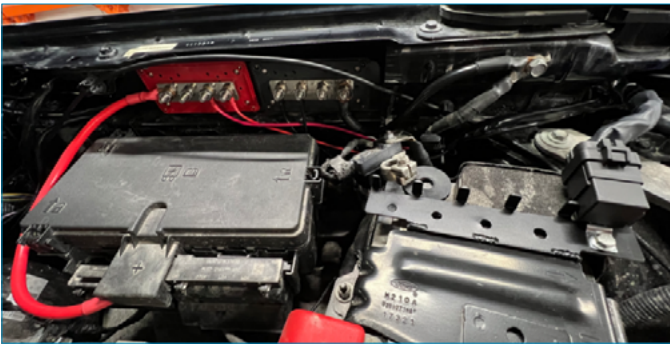

**24.** Route the harness down between the radiator and radiator support structure. Repeat this step for both wire harnesses.



**25.** Once the connector on the end of the wire harness makes it past the bottom of the grill support structure, carefully pull on the wire harness until the slack in the engine bay is removed. Repeat this step for both wire harnesses.



**26.** Remove the plastic trim covers from the bumper by pulling outward to release the clips securing them in place.



**27.** Remove the upper, inner 15mm bumper bolt from both sides of the bumper as shown in the images below.



Continued on next page

**28.** Assemble the pod lights as shown in the image below.

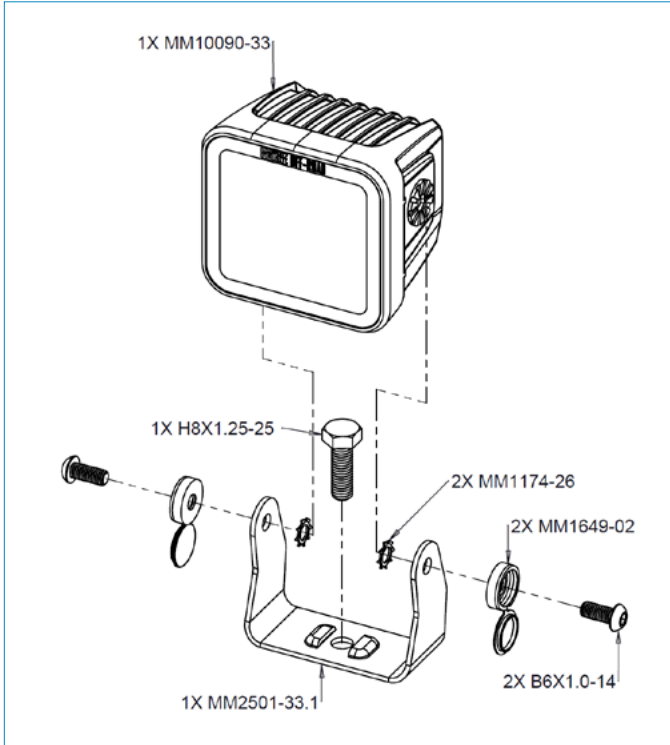

**29.** Install the pod light assemblies onto the tube (MM2532) as shown in the image below.

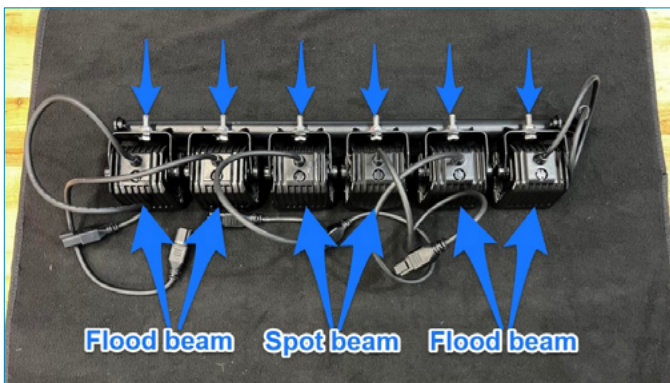

**30.** Loosely install the driver's side bracket (MM2533-02) to the tube as shown in the image below using two of the provided M8 button head bolts and M8 fastener caps. (2x B8X1.25-12 and 2x MM1649-03)

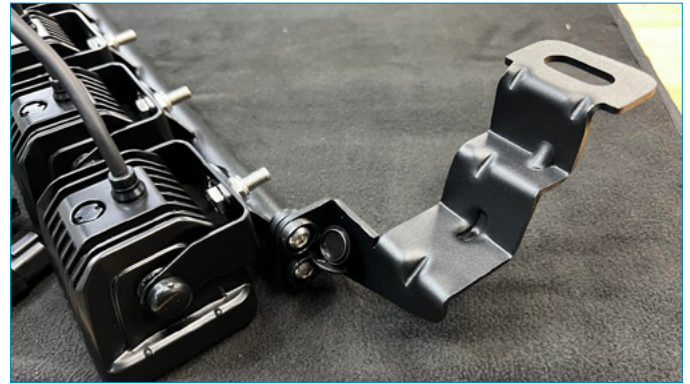

**31.** Loosely install the passenger's side bracket (MM2533-01) to the tube as shown in the image below using two of the provided M8 button head bolts and M8 fastener caps. (2x B8X1.25-12 and 2x MM1649-03)

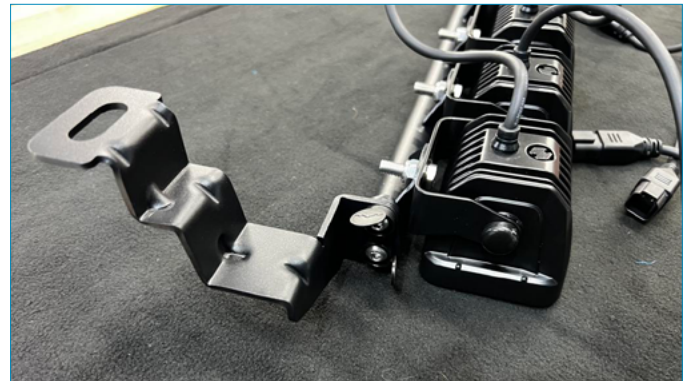

**32.** Rest the light and bracket assembly on a suitable surface in front of the bumper, then connect the spot beam lights to the spot beam harness. If installing with the non-upfitter harnesses, connect both spot beam lights to one harness. [Images on next page]

Continued on next page

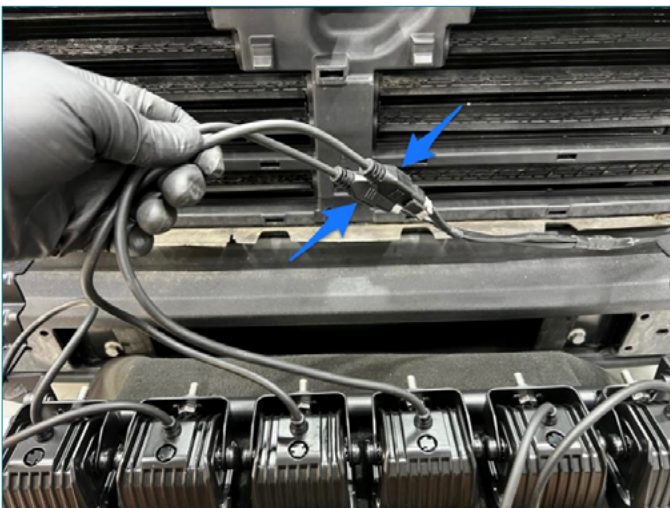
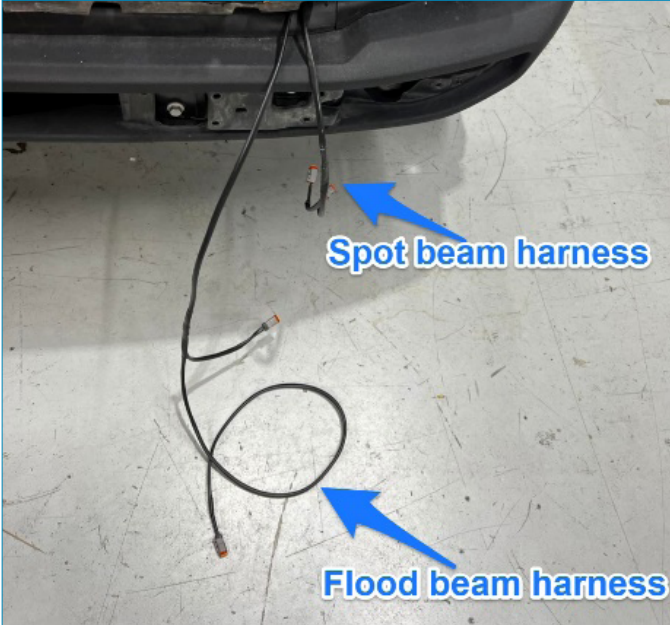

**33.** Connect the driver's side flood beam lights to the short end of the flood beam harness using one of the provided adapter harnesses. If installing with the non-upfitter harnesses, connect both driver's side flood beam lights to one of the connectors on the second harness using one of the provided adapter harnesses. [Image top right]

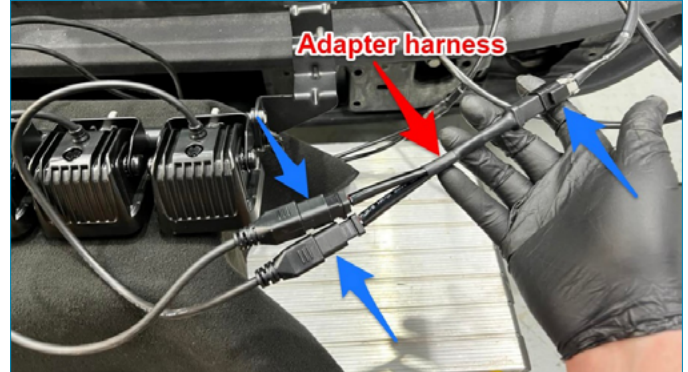

**34.** Connect the passenger's side flood beam lights to the long end of the flood beam harness using one of the provided adapter harnesses. If installing with the non-upfitter harnesses, connect both passenger's side flood beam lights to one of the connectors on the second harness using one of the provided adapter harnesses.

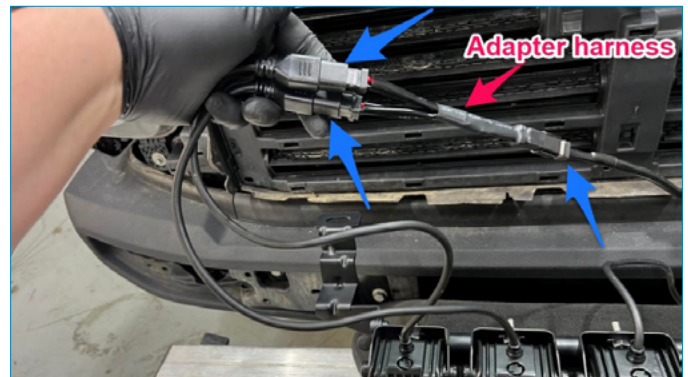

**35.** Push the harness connectors into the front of the vehicle, between the grill support structure and bumper.



Continued on next page

**36.** Route the wire harnesses over/under the front fascia clips as shown in the image below.

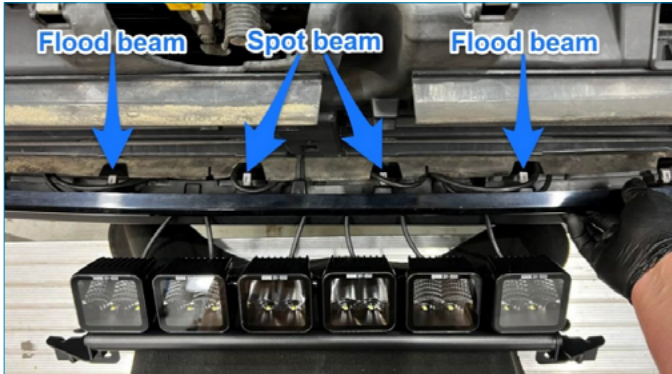

**37.** Reinstall the front fascia. Be sure all the clips are fully seated and that the wires are not being pinched.



**38.** Push the side of the front fascia back into place. Do this on both sides.

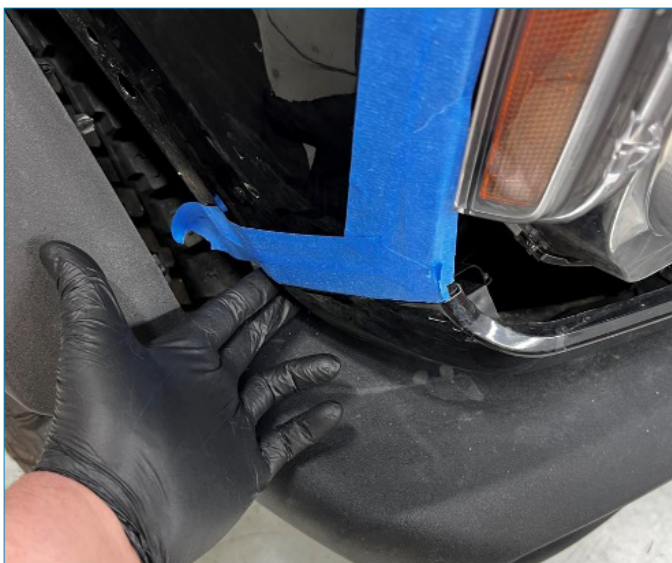

**39.** Reinstall the grill, then push it in place to engage all the clips.



**40.** Fasten the light brackets to the front bumper with the previously removed bumper bolts. Torque the bolts to 81 lb-ft (110 Nm). (2x 15mm bolts)



**41.** Tighten the bolts securing the tube to the brackets and snap the fastener caps closed.



Continued on next page

**42.** Use a level to adjust the lights as desired. Once adjusted, tighten the bolts securing the lights to the bracket.



**43.** Reinstall the plastic trim covers onto the bumper.

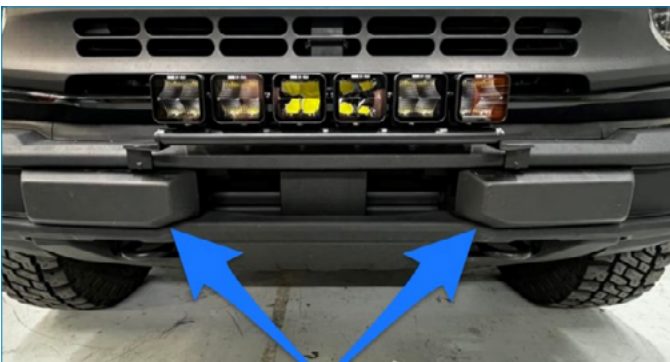

**44.** Use the provided zip-ties to bundle up and secure all loose wires in place.

**45.** Reinstall the front grill to the grill support structure and secure it in place with the previously removed hardware. If equipped, reconnect the front camera and camera washer hose. (4x 10mm bolts)

**46.** Reinstall the radiator cover. (9x pop clips)

**Congratulations you have completed the installation**

Continued on next page

### DISPOSAL INSTRUCTIONS

- › Do not dispose of any product as unsorted municipal waste. Use separate collection facilities. Contact your local authority for information regarding the collection systems available.

#### VIEW WARRANTY INFO



#### WARNING

Cancer and  
Reproductive Harm  
[www.P65Warnings.ca.gov](http://www.P65Warnings.ca.gov)



- › This product can expose you to chemicals which are known to the state of California to cause cancer. For more information visit:  
[www.p65warnings.ca.gov](http://www.p65warnings.ca.gov)