



INSTALLATION GUIDE

Direct-Fit 30" Light Bar, Fits 2021+ Ford Bronco w/ Modular Bumper
SKU: BNLT-BR-21M-B30

TABLE OF CONTENTS

1. RESOURCES & CONTACT INFO

2. EXPLODED VIEW

3. IMPORTANT SAFETY INFORMATION

REQUIRED TOOLS

INSTALL TIME & DIFFICULTY

INSTALLATION INSTRUCTIONS

11. DISPOSAL & WARRANTY INFORMATION

RESOURCES & CONTACT



CALL 1.877.466.4744

CUSTOMER SERVICE HOURS: MON-FRI 9:00AM-7:00PM EST



@BORNEOFFROAD



@BORNEOFF-ROAD



BORNEOFFROAD



@BORNEOFFROAD



ENGINEERING BLOG

WWW.BORNE.COM/ENGINEERING

PARTS BREAKDOWN

PART NUMBER	DESCRIPTION	QTY
MM10091-SS30	30 INCH LIGHT BAR	1
MM2527-01	BRACKET 1	1
MM2527-02	BRACKET 2	1
B8X1.25-14	M8 BUTTON HEAD BOLT	2
MM1649-03	M8 FASTENER CAP	2
MM10082	WIRE HARNESS (NOT SHOWN)	1
MM1164-01	ZIP-TIE (NOT SHOWN)	12

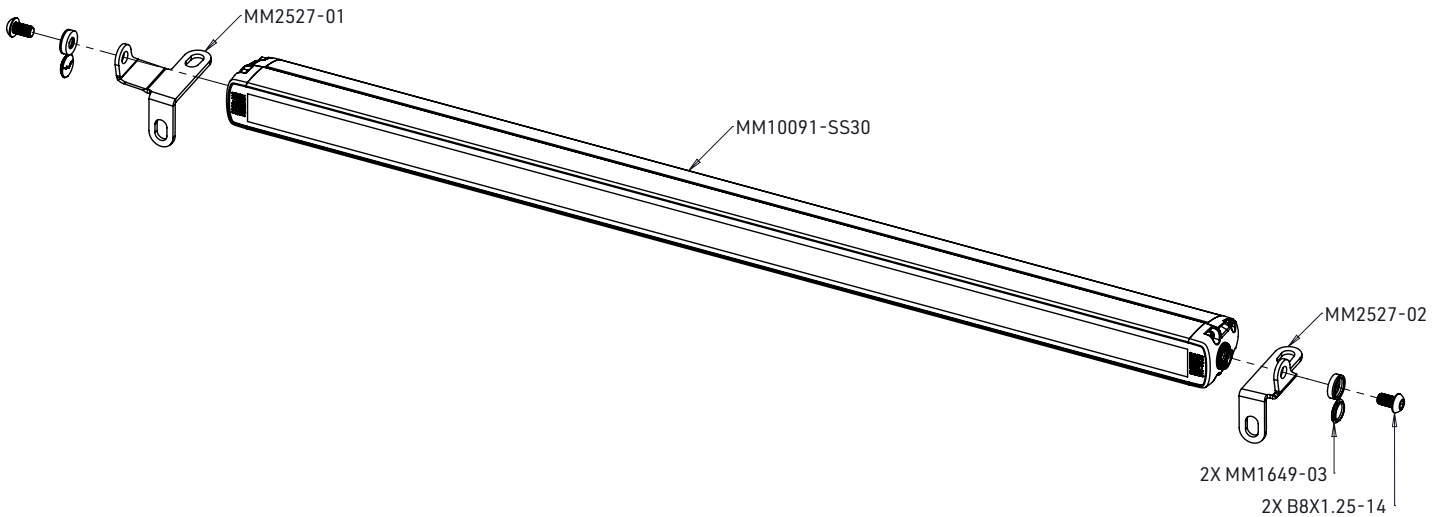

Continued on next page

IMPORTANT SAFETY INFORMATION

- ▶ Borne Off-Road recommends you use safety glasses and protective gloves during the installation of our products
- ▶ Raise vehicle only on jack stands or on a vehicle lift
- ▶ Allow vehicle to cool completely prior to attempting installation
- ▶ Borne Off-Road is not responsible for any vehicle damage or personal injury due to installation errors, misuse, or removal of Borne Off-Road products
- ▶ If you need any assistance while installing our products, reach out to our Customer Service Team at 1-877-466-4744

REQUIRED TOOLS

PANEL TOOL	1/4" RATCHET AND EXTENSION
PAINTERS/MASKING TAPE	8MM SOCKET
ELECTRICAL TAPE	10MM SOCKET
METAL ROD	T40 TORX
WIRE STRIPPER	5MM ALLEN WRENCH
DEUTSCH CLOSED BARREL TERMINAL CRIMP TOOL (FOR SIZE 12 TERMINAL)	SIDE CUTTERS
	LEVEL

INSTALL TIME: 3 HOURS

INSTALL DIFFICULTY: 

INSTALLATION INSTRUCTIONS

1. If equipped, remove the stock bull bar from the bumper. (8x T40 Torx bolts)



2. Remove the radiator cover. (9 pop clips)



3. Remove the bolts securing the grill to the grill support structure. (4x 10mm bolts)



Continued on next page

4. If equipped, disconnect the electrical harness for the front camera and the fitting for the camera washer.



5. Locate the front three rotating fasteners securing the fender flares in place and turn them 90 degrees, then pull outward to partially remove them. Do this on both sides.



6. Apply masking tape to the front sections of both fenders as shown in the images below.

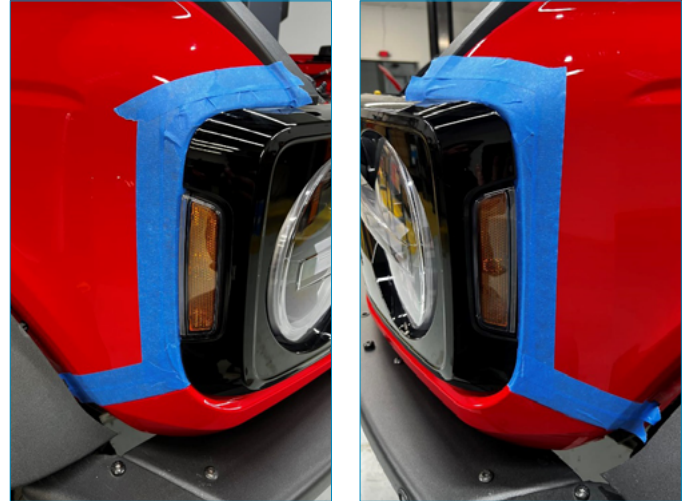

7. Carefully pull on both sides of the grill to unseat the grill from the grill support structure, then remove the grill from the vehicle.

8. Pull outward on the rear corners of the front fascia to unseat it from the clips that secure it to the fenders. Do this on both sides.



9. Unseat the front fascia from the clips that secure it to the grill support structure. Once fully unseated, remove the front fascia from the vehicle.



Continued on next page

If installing the light kit compatible with the factory Upfitter switches, proceed to step 10. If installing a light kit using the non-Upfitter wiring harness, proceed to step 16.

10. The Upfitter auxiliary wires are located on the driver's side of the vehicle next to the brake booster. Locate the green with brown stripe wire (Aux 2) and trim the cap off the end. Once trimmed, strip approximately ¼" of insulation off the wire. Once stripped, carefully insert the wire into one of the provided female closed barrel terminals, ensuring all strands make it into the terminal, then crimp it in place. This green with brown stripe wire corresponds to the auxiliary 2 Upfitter switch. The 30-inch light bar draws approximately 11 amps at 12VDC, which means it must be connected to the auxiliary 1 or 2 circuits. Two additional auxiliary circuits will also be needed, one for the white DRL and one for the amber DRL. Any two of the remaining circuits can be used for the DRLs. For this install guide, we chose auxiliary 3 (violet with green stripe wire) and 4 (brown wire). Trim the caps off the ends of the two additional upfitter auxiliary wires, then strip approximately ½" of insulation. For each wire, fold the stripped section over, then insert the wire into one of the provided female closed barrel terminals. Once inserted, crimp the terminal in place. (3x Female Closed Barrel Terminals)

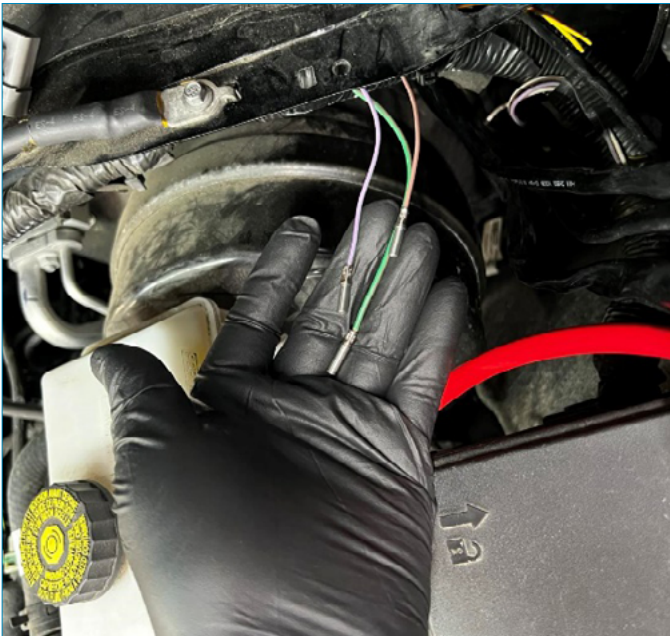

11. Insert the green with brown stripe wire into position 4 of the provided male wire harness connector. Insert the violet with green stripe wire into position 3; this will power the amber DRL. Insert the brown wire into position 2; this will power the white DRL. A clicking sound will indicate that the terminals have been pressed far enough to engage with the locking tabs inside the connector.

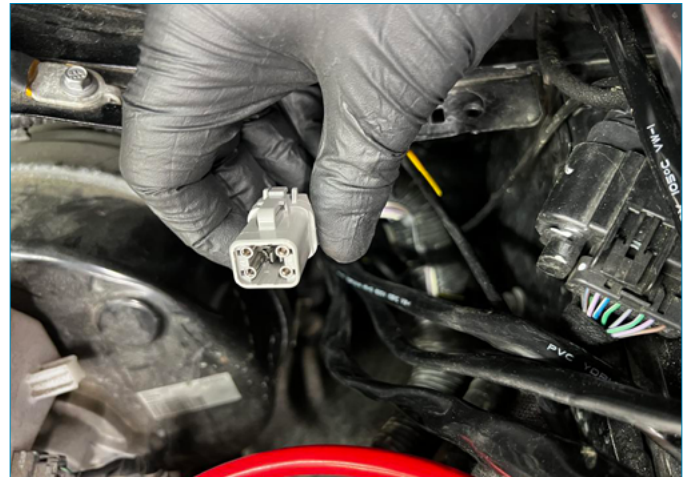

Continued on next page

12. Perform a visual inspection of the terminals from the front side of the connector. Ensure the locking rim of each terminal rests on the locking tab inside the connector. Once confirmed, insert the provided locking wedge into the center of the fitting. The wedge will be fully seated when it sits flush with the face of the connector. Next, secure the ground ring terminal to the chassis ground located above the brake booster. (1x Locking Wedge, 1x 8mm Bolt)



13. Connect the direct-fit wire harness to the connector.



14. Route the harness along the driver's side fender and down between the radiator and radiator support structure.

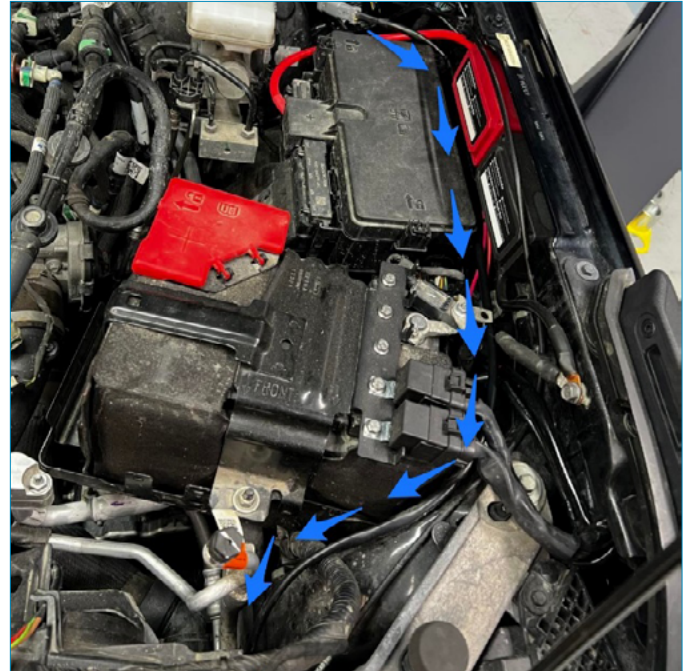

15. Once the connector on the end of the wire harness makes it past the bottom of the grill support structure, carefully pull on the wire harness until the slack in the engine bay is removed. Proceed to step 26.

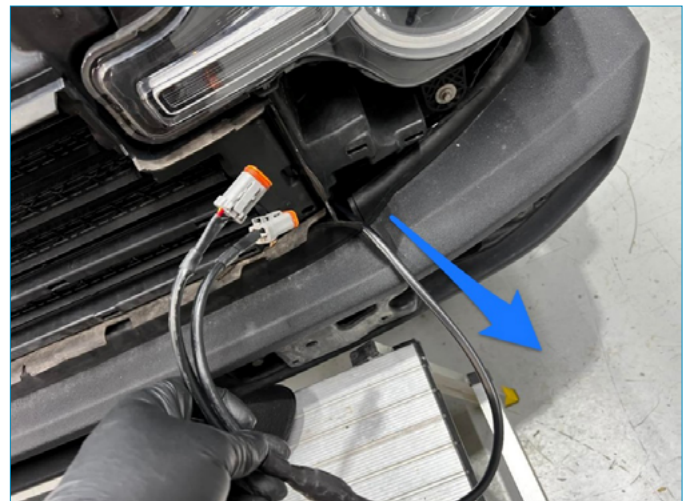

Continued on next page

16. Remove the three female spade terminals from the two-position light bar switch. Once removed, tape the three wires together so they do not get mixed up with the wires for the three-position switch. The female spade terminals have a locking feature that must be depressed to unlock them from the blades on the back side of the switch.

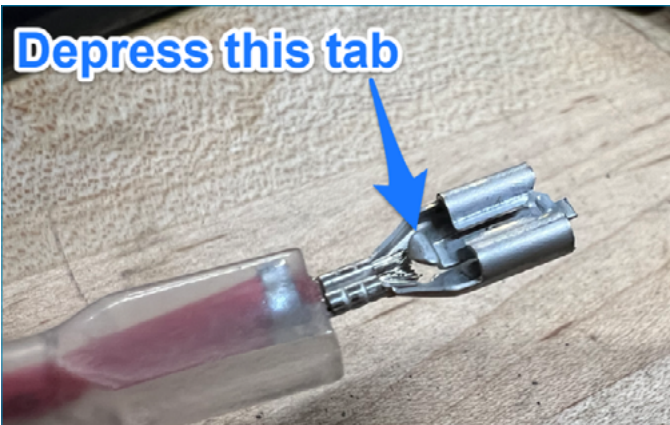
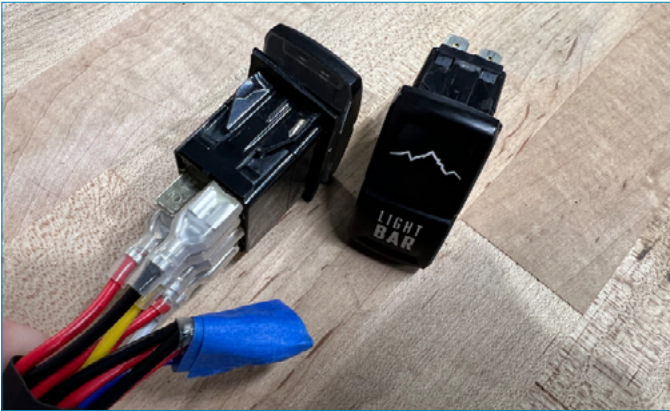

17. Remove the five female spade terminals from the three-position amber/white switch. Once removed, tape the switch harness to a metal rod. Feed the harnesses inside the driver-side fender from the battery back to the cowl.



18. Feed the switch wiring harness through the driver's side of the firewall. For this installation, we drilled a hole in the rubber plug next to the brake booster to pass the wires through.

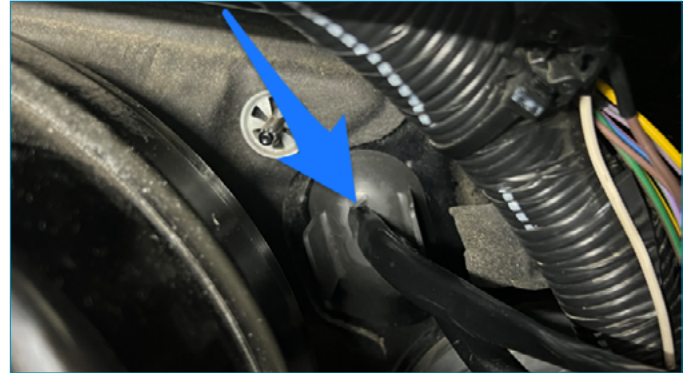

19. Pull the remaining length of the switch wire harness through the firewall, then route the wiring to the desired switch mounting location. For this installation, we used the Borne Off-Road Bronco Direct-Fit Switch Panel, which mounts above the center console.



20. Feed the wires through the switch holes, then reconnect them to the switches, as shown in the diagrams on the next page. Once the wires are reconnected, install the switches into the mounting holes.



Continued on next page

2 POSITION SWITCH: ON - OFF

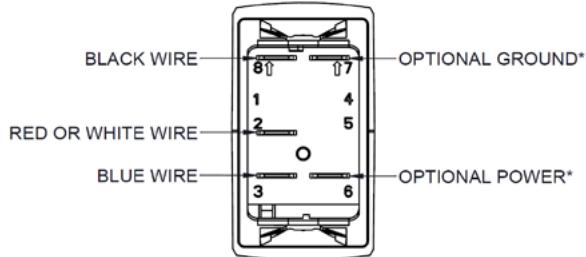

*TO ILLUMINATE BOTTOM HALF OF SWITCH. WIRING NOT INCLUDED.

3 POSITION SWITCH: ON - OFF - ON

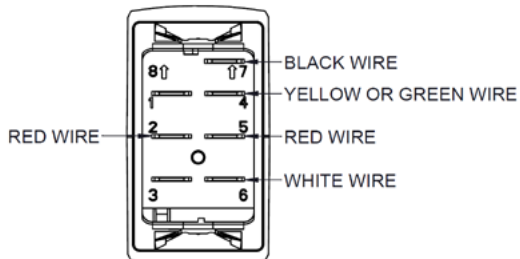

21. Secure all loose wiring under the dashboard and driver-side footwell. The wire must be secured out of the way of the pedals, steering column, and any other moving components.

22. Find a suitable location to mount the wire harness relay. For this installation, we used our Borne Off-Road Bronco Direct-Fit Battery Relay Holder.

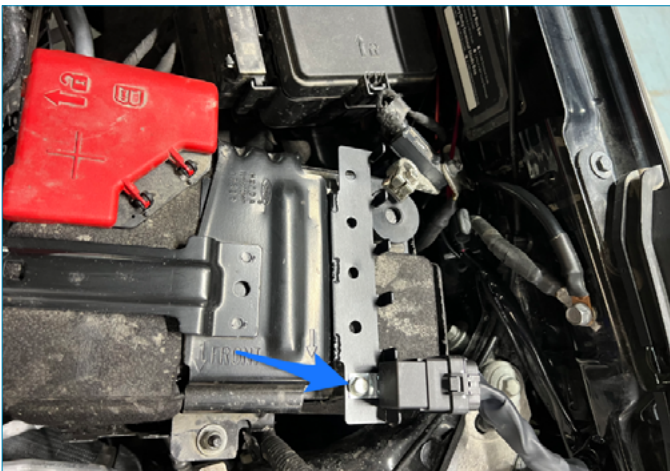

23. Connect the positive wire from the harness to a suitable power distribution point on the vehicle (this could be the battery if no other option is available). Connect the wire harness ground wire to a suitable chassis ground. For this installation, we used our Borne Off-Road Bronco Direct Fit Bus Bar Kit.



24. Route the harness down between the radiator and radiator support structure.



25. Once the connector on the end of the wire harness makes it past the bottom of the grill support structure, carefully pull on the wire harness until the slack in the engine bay is removed.



Continued on next page

26. Remove the inner T40 Torx bolts from both sides of the bumper as shown in the image below.

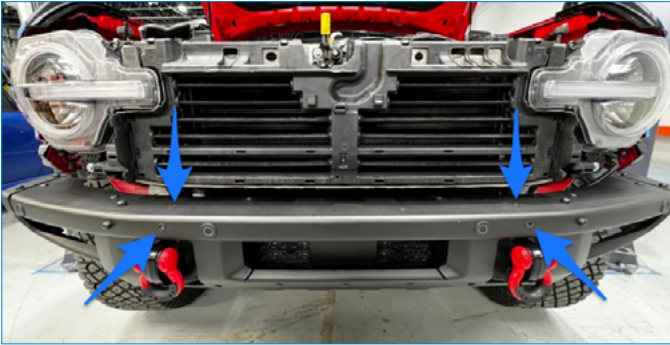

27. Loosely install the driver's side bracket (MM2527-02) to the light bar as shown in the image below using one of the provided M8 button head bolts and M8 fastener caps. (1x B8X1.25-14 and 1x MM1649-03)



28. Loosely install the passenger's side bracket (MM2527-01) to the light bar as shown in the image v using one of the provided M8 button head bolts and M8 fastener caps. (1x B8X1.25-14 and 1x MM1649-03)



29. Rest the light and bracket assembly on a suitable surface in front of the bumper, then connect the light to the wire harness. Push the harness connector into the front of the vehicle, between the grill support structure and bumper. Route the wire harness over/under the front fascia clips as shown in the images below.

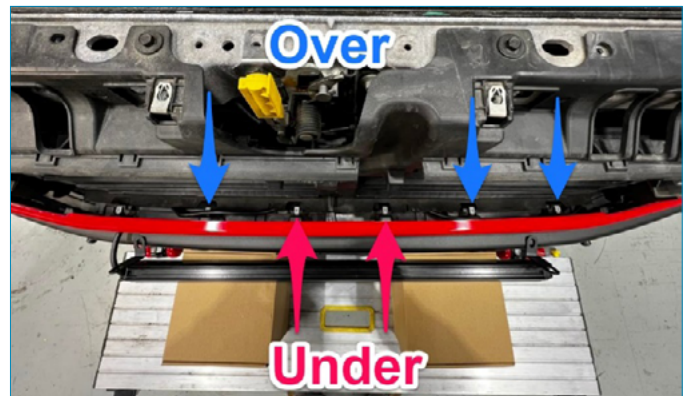
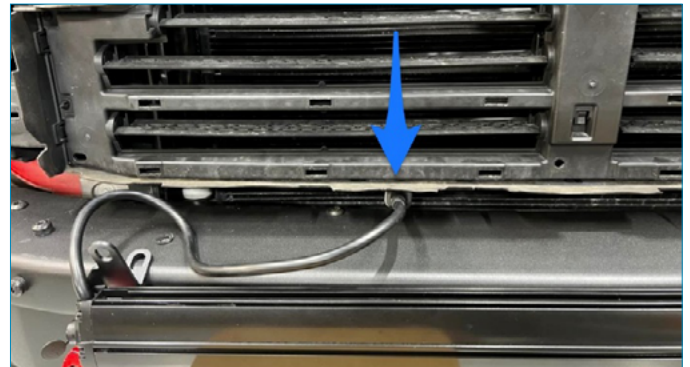

30. Reinstall the front fascia. Be sure all the clips are fully seated and that the wires are not being pinched.

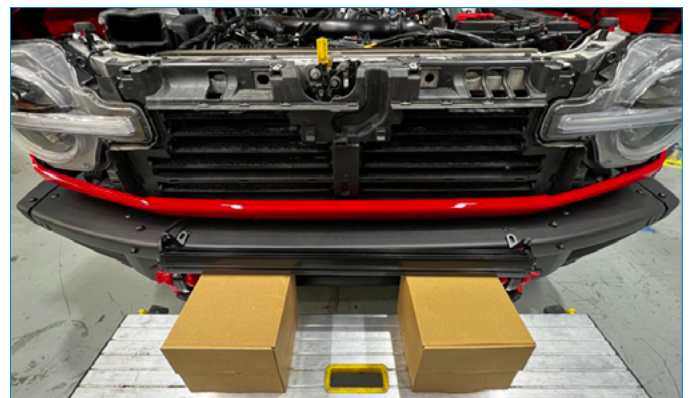

Continued on next page

31. Push the side of the front fascia back into place.
Do this on both sides.



32. Reinstall the grill, then push it in place to engage all the clips.

33. If equipped, reinstall the stock bull bar first, then install the light bracket on top of the bull bar as shown in the image below. (8x T40 Torx bolts).



34. Fasten the light brackets to the front bumper with the previously removed bumper bolts. (4x T40 Torx bolts)



35. Use a level to adjust the light as desired. Once adjusted, tighten the bolts securing the light to the bracket.



36. Use the provided zip-ties to bundle up and secure all loose wires in place.

37. Reinstall the front grill to the grill support structure and secure it in place with the previously removed hardware. If equipped, reconnect the front camera and camera washer hose. (4x 10mm bolts)

38. Reinstall the radiator cover. (9x pop clips)

Congratulations you have completed the installation.

Continued on next page

DISPOSAL INSTRUCTIONS

- › Do not dispose of any product as unsorted municipal waste. Use separate collection facilities. Contact your local authority for information regarding the collection systems available.

VIEW WARRANTY INFO



WARNING
Cancer and
Reproductive Harm
www.P65Warnings.ca.gov



- › This product can expose you to chemicals which are known to the state of California to cause cancer. For more information visit: www.p65warnings.ca.gov