



Ford Mustang (with 8" touchscreen) 2015-Up

Visit MetraOnline.com for more detailed information about the product, and up-to-date vehicle specific applications

KIT FEATURES

- Designed specifically for the Pioneer DMH-C5500NEX 8-inch radio
- Touchscreen display for climate and personalization features
- Included interface for climate and steering wheel functions
- Integrated passenger airbag indicator
- Painted charcoal

KIT COMPONENTS

- A) Radio trim panel (with touchscreen display) • B) Radio brackets • C) Engine start/stop circuit board and cover • D) (6) #4 x 1/2" Phillips screws
- E) (4) Panel clips • F) USB cable • G) HVAC interface and wiring harness (not shown) • H) Antenna adapter (not shown)

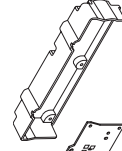
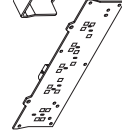
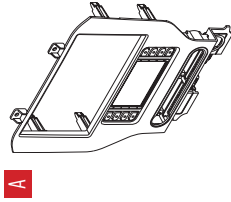

TABLE OF CONTENTS

Dash Disassembly	2-3
Kit Preparation	4-5
Kit Assembly	6
Access Interface Installation	7-16
Final Assembly	11

WIRING & ANTENNA CONNECTIONS

Wiring Harness: Access interface built into touchscreen

Antenna Adapter: Included with kit

TOOLS REQUIRED

- Panel removal tool • Phillips screwdriver
- 9/32" socket wrench • Cutting tool
- Torx T-10 screwdriver

Attention! Let the vehicle sit with the key out of the ignition for a few minutes before removing the factory radio. When testing the aftermarket equipment, ensure that all factory equipment is connected before cycling the key to ignition.

DASH DISASSEMBLY

1. Open the passenger door and remove the trim panel from the side of the dash. (Figure A)
2. Open the glove box and remove the trim panel on the right side. (Figure B)
3. Unclip and remove the trim/vent dash panel. (Figure C)

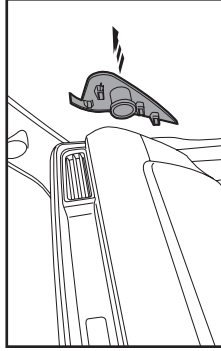

(Figure A)

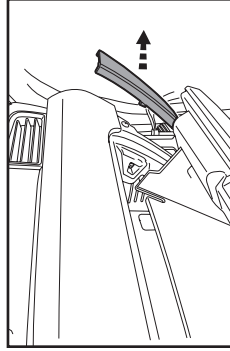

(Figure B)

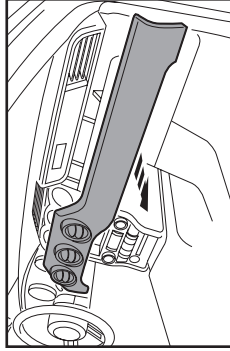

(Figure C)

4. Remove the rubber tray cover in front of the shifter, and then remove the (2) 9/32" screws exposed. (Figure D)
5. Unclip and remove the front side panels from each side of the center console. (Figure E)
6. Remove the (2) 9/32" screws from each side of the center console. (Figure F)

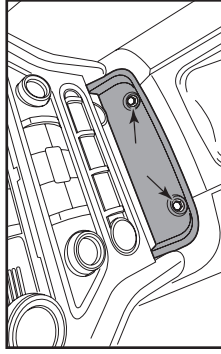

(Figure D)

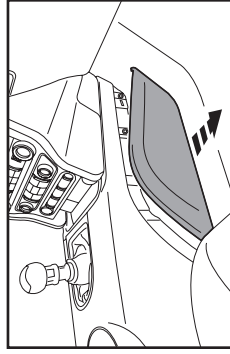

(Figure E)

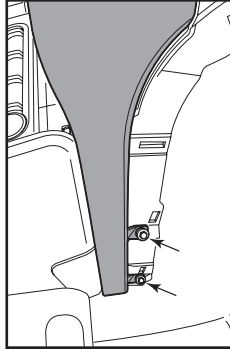

(Figure F)

Continued on the next page

7. Unclip the shifter trim bezel and slightly pull it up to clear the center console trim bezel removal.

8. Open the center console storage compartment. Unclip the center console trim bezel, then slide it toward the rear of the vehicle to remove it. (Figure G)

Note: The complete center console does not need to be removed, but if it is desired to be removed, the **Push-to-Start module** must be connected when testing the kit.

9. Remove the plastic tray in front of the shifter.

10. Remove the center plastic trim (knockout) between the power outlet and USB jack. (Figure H)

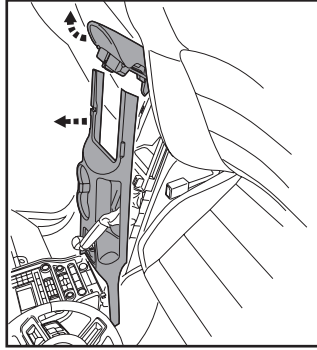

(Figure G)

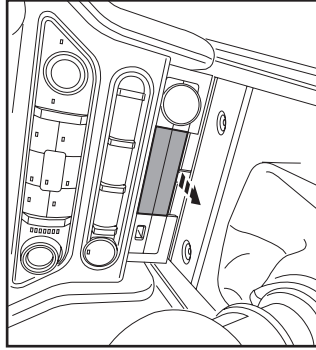

(Figure H)

Ensure that the vehicle is completely off before proceeding onto the following (3) steps:

11. Remove the (4) 9/32" screws securing the radio/climate control panel, and then unclip, unplug, and remove. (Figure I)
12. Remove the (4) 9/32" screws securing the display screen, then unplug and remove. (Figure I)
13. Remove the (4) 9/32" screws securing the radio chassis, then unplug and remove. (Figure I)

Continue to Kit Preparation

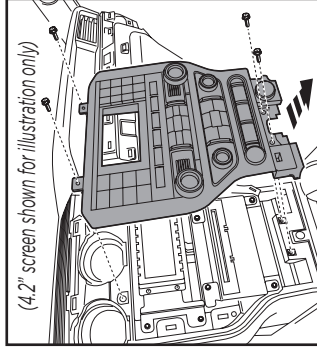

(Figure I)

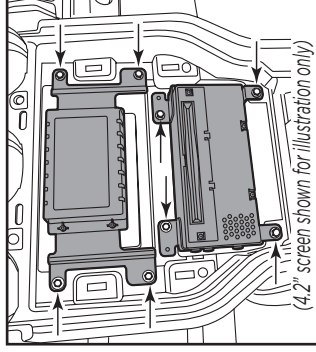

(Figure J)

KIT PREPARATION

1. Cut and remove the shaded area from the sub-dash to allow clearance for the aftermarket radio. (Figure A)

From the factory radio/climate control panel:

2. Remove the (10) T-10 Torx screws securing the plastic panel cover to the rear of the panel, and then remove. (Figure B)
3. Remove the (5) T-10 Torx screws securing the circuit board, and then remove. (Figure C)

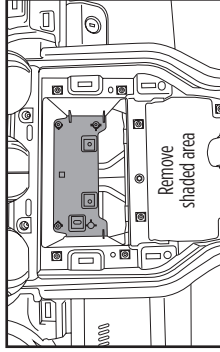

(Figure A)

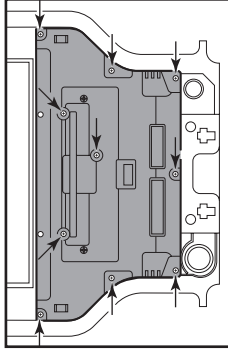

(Figure B)

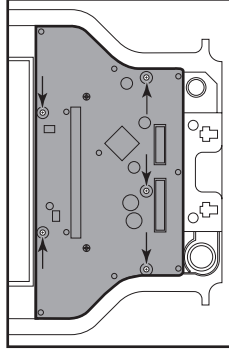

(Figure C)

4. Remove the rubber button membrane from the back of the engine start/stop switch panel. (Figure D)
5. Remove the engine start/stop switch panel. (Figure E)
6. Press in on the (2) retaining tabs inside the power outlet to remove the inner portion, and then unsnap the outer ring and cover. (Figure F)

Continued on the next page

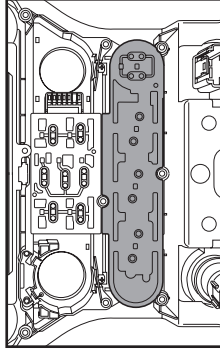

(Figure D)

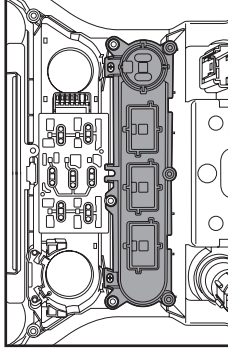

(Figure E)

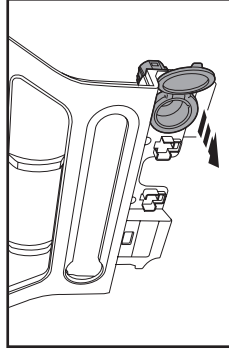

(Figure F)

To the 108-FD6CH radio trim panel:

7. Attach the **engine start/stop switch panel**, and then the rubber button membrane. (Figure G)
8. Secure the **engine start/stop circuit board and cover** to the switch/cover assembly using (6) #4 x 1/2" Phillips screws provided. (Figure H)

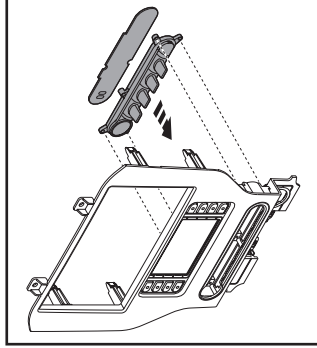

(Figure G)

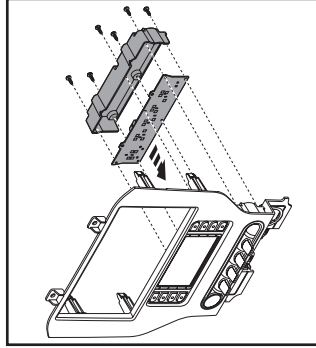

(Figure H)

9. Insert the **USB cable** into the USB slot, through the rear. (Figure I)
10. Attach (4) **panel clips** provided. (Figure J)

Continue to Kit Assembly

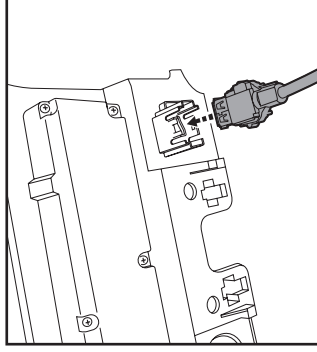

(Figure I)

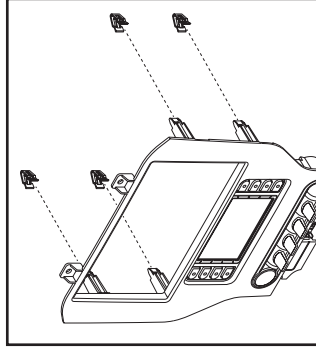

(Figure J)

KIT ASSEMBLY

Note: For the following steps, reference the installation manual provided with the radio for which hardware to use. The display screen and radio chassis use two different types of screws.

1. Secure the **radio brackets** to the radio chassis using (4) screws supplied with the radio. (Figure A)
2. Secure the radio display to the **radio brackets** using (4) screws supplied with the radio. (Figure B)

*Continue to Axxess
Interface Installation*

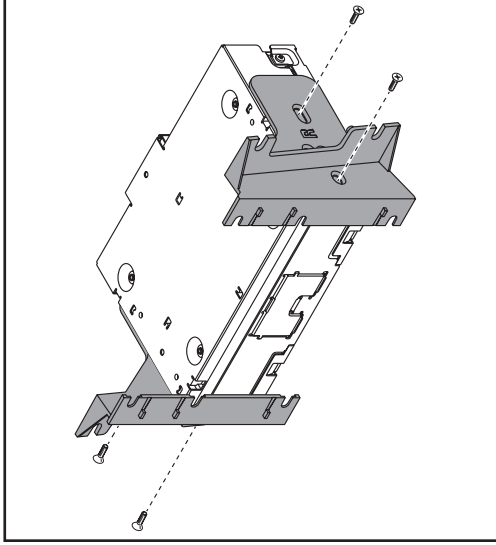

(Figure A)

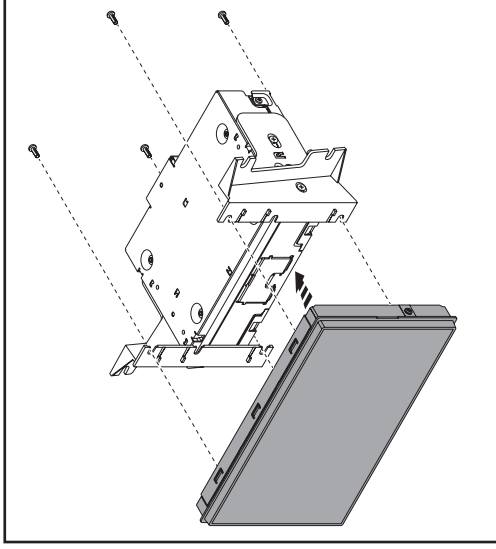

(Figure B)

ACCESS INTERFACE INSTALLATION

INTERFACE FEATURES

- Provides accessory power (12-volt 10-amp)
- Retains R.A.P. (retained accessory power)
- Provides NAV outputs (parking brake, reverse, speed sense)
- Retains audio controls on the steering wheel
- Retains the factory backup camera
- Retains balance
- Micro-B USB updatable

TABLE OF CONTENTS

Connections.....	8-9
Installation	10
Programming	11
Touchscreen display operation	12-13
Steering wheel control settings	14-15
Troubleshooting.....	16

INTERFACE COMPONENTS

- Access interface (built into the touchscreen display)
- Main harness
- HVAC interface
- HVAC interface harness
- 16-pin harness with stripped leads
- 54-pin backup camera harness
- 4-pin harness with yellow RCA jacks

TOOLS REQUIRED

- Crimping tool and connectors, or solder gun, solder, and heat shrink
- Tape • Wire cutter • Zip ties

From the 16-pin harness with stripped leads to the aftermarket radio:

- Connect the **Red** wire to the accessory wire.
- Connect the **Blue/White** wire to the amp turn on wire. This wire must be connected to hear sound from the factory amplifier.
- Connect the **Orange/White** wire to the illumination (lighting switch) wire
- Connect the **Gray** wire to the right front positive speaker output.
- Connect the **Gray/Black** wire to the right front negative speaker output.
- Connect the **White** wire to the left front positive speaker output.
- Connect the **White/Black** wire to the left front negative speaker output.
- Connect the **Green** wire to the left rear positive speaker output.
- Connect the **Green/Black** wire to the left rear negative speaker output.
- Connect the **Purple** wire to the right rear positive speaker output.
- Connect the **Purple/Black** wire to the right rear negative output.
- Connect the **Green/Purple** wire to the reverse wire.
- Connect the **Light Green** wire to the parking brake wire.

- Tape off and disregard the following (2) wires, they will not be used in this application:
Blue/Pink, Brown

From the main harness to the aftermarket radio:

- Connect the **Black** wire to the ground wire.
- Connect the **Yellow** wire to the battery wire.
- Connect the **Blue** wire to the system control (Blue/White) wire.
- Disregard the **Red** and **White** RCA jacks labeled “RSE/SYNC/SAT”, they will not be used in this application.
- Disregard the **Red** and **White** RCA jacks labeled “FROM 3.5”, they will not be used in this application.
- Tape off and disregard the following (4) wires, they will not be used in this application:
Green, Green/Black, Purple, Purple/Black

Continued on the next page

3.5mm jack - steering wheel control retention:

The 3.5mm jack is to be used to retain audio controls on the steering wheel control.

- Connect the 3.5mm jack into the **wired remote input** from the aftermarket radio. Refer to the manual provided with the radio if in doubt as to where the 3.5mm jack goes to.

54-pin backup camera harness:

There are two different methods for connecting the factory backup camera.

If retaining the camera to the aftermarket radio is desired:

- Connect the **Yellow** RCA jack to the **rear view camera input** from the aftermarket radio.

If retaining the camera to the touchscreen display is desired:

- Connect the **Yellow** RCA jack, to the **Yellow** RCA jack from the **4-pin harness with yellow RCA jacks** labeled “Rearview camera”.

Note: If this method is chosen, the backup camera option must be enabled in **Configuration Settings**.

- Disregard the **Yellow** RCA jack from the **4-pin harness with yellow RCA jacks** labeled “AUX video”, it will not be used in this application.

It is highly advisable to read the following steps beforehand, to ensure a clear understanding of what is to be expected. The following steps must be done in the order that they are numbered.

With the vehicle completely off:

Touchscreen display

1. Connect the **16-pin harness with stripped leads** into port "B" in the touchscreen display.
2. Connect the **main harness** to the wiring harnesses in the vehicle. These harnesses are the ones removed in step 13 of dash disassembly. Then insert the **main harness** into port "A" in the touchscreen display. But do not install this harness until exactly before step 1 from the **Programming** section. This is a timed process.
3. Connect the **4-pin harness with yellow RCA jacks** into port "C" in the touchscreen display.
4. Disregard ports "D" and "E", they will not be used in this application.
5. Port "F" is an update port for future firmware upgrades.

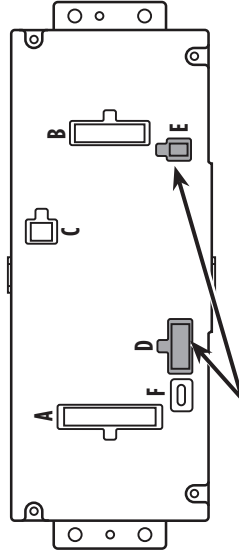

Note: DO NOT CONNECT!

HVAC interface

6. Connect the **HVAC interface harness** into the **HVAC interface**, and then to the wiring harnesses in the vehicle. These harnesses are the ones removed in step 11 of dash disassembly.
 - a. Then connect the **10-pin harness** into the engine start/stop circuit board assembly. **Attention!** There are (2) 10-pin connectors, one in the engine start/stop circuit board assembly, and one in the touchscreen display. Use only the appropriate connector and disregard the other one. If the incorrect port is accidentally used, the vehicle will need to be reset by removing the battery for a couple minutes.
7. **Note:** Disregard the 4-pin flat to 4-pin stacked harness, it will not be used in this application. Connect the 6-pin harness from the **main harness** to the **HVAC interface**.
8. Connect the female connector from the **54-pin backup camera harness** to the wiring harness in the vehicle. This connector is located behind the factory display screen, which was removed in step 12 of dash disassembly. **Note:** Disregard the male connector, it will not be used in this application.
9. Locate the factory antenna connector in the dash and complete all necessary connections to the radio. Use the antenna adapter provided to adapt the factory antenna connector to the aftermarket radio.

1. Refer to step 2 from the **Installation** section.
2. Press the push-to-start button to start the vehicle.
Note: If the Push-to-Start module in the center console has been disconnected, reconnect it.
3. Program the kit:
 - a. Once the touchscreen display loads up, select the vehicle type.
 - b. Wait until the radio comes on, and the touchscreen display shows **SWC Configured**.
This process may take up to 3 minutes.

Note: If the touchscreen display doesn't load up, or the radio doesn't come on within 3 minutes, and/or the touchscreen display doesn't show **SWC Configured**, check all connections, then reset the interface and try again. Refer to the **Troubleshooting** section.

4. Cycle the key off. If the driver's door is closed, open and close the door. Cycle the key back on.
5. Test all functions of the installation for proper operation, before reassembling the dash.

1. Connect the **USB cable** attached to the **radio trim panel**, to the USB port in the back of the radio.
2. Secure the completed assembly into the upper dash using the factory hardware removed in step 12 of dash disassembly.
3. Snap the **radio trim panel** over the completed radio assembly, then reassemble the dash in reverse order of disassembly.

TOUCHSCREEN DISPLAY OPERATION

Climate Control screen



- This is the climate control screen which will be displayed on the touchscreen display. This is considered the **Main Menu**.
- The upper left tab with (3) arrows will take you to the screen where the **Heated/Cooled Seats** and **Heated Steering** are now placed, if applicable.
- The upper right tab with the gear icon will take you to the **Configuration Settings** screen.
- The climate controls will function in the same manner that they did with the factory climate controls.

Continued on the next page

Configuration Settings



- **Backlight**
 - For controlling the color of the buttons and back-light intensity.
- **Backup Camera**
 - Enable/disables the backup camera image to the touchscreen display. Disabled by default.
- **Forward Camera**
 - To direct where the camera image will be shown, or to disable the camera
- **Ambient Lighting Color**
 - For adjusting the ambient light color in the vehicle



- **Steering Wheel Controls**
 - Remap Buttons – For remapping the steering wheel control buttons
 - Dual Assign – For dual assigning the steering wheel control buttons (long button press)
 - Select Radio – For auto detecting the radio, or changing the radio type
- **Clock**
 - For setting the clock and hour mode
- **System Configuration**
 - About – Information regarding the software in the kit
 - Temperature Unit - To change between Celsius and Fahrenheit
 - Digital Amp Gain - For adjusting the output gain to the amplifier
 - Reset Vehicle Type - To reset the kit to default settings

Remap Buttons

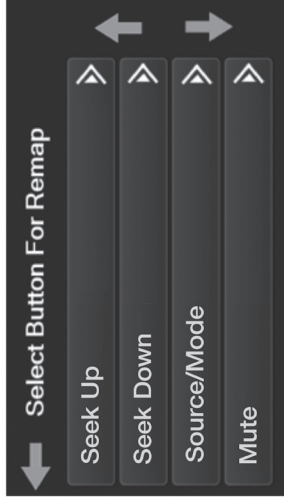

Dual Assign



- The interface has the ability to change the button assignment for the steering wheel control audio buttons, except Volume-Up and Volume-Down. Follow the prompts on the touchscreen display to remap the steering wheel control audio button(s) to your liking.
Note: The aftermarket radio may not have all of these commands. Please refer to the manual provided with the radio, or contact the radio manufacturer, for specific commands recognized by that particular radio.

- The interface has the capability to assign two functions to a single button, except Volume-Up and Volume-Down. Follow the prompts on the touchscreen display to program the button(s) to your liking.
Note: Seek-Up and Seek-Down come programmed as Preset-Up and Preset-Down for a long button press.

Continued on the next page

Select Radio



- To show which brand radio is “auto detected” to the interface, press the **Autodetect** button. The radio detected will have a filled in circle. If the incorrect radio is shown, select **Pioneer**.

*** Note:** If the interface shows an **Alpine** radio, that means the interface doesn't detect a radio connected it, i.e., an open connection. Verify that the 3.5mm jack is connected to the correct steering wheel jack in the radio.



TROUBLESHOOTING

Resetting the interface

Option #1

1. With everything connected and the car running.
2. Hold the bottom (Z) buttons for 3 seconds, then release. (Figure A)
(The screen will turn black and then put you in the vehicle selection screen)
3. Select your vehicle and wait till the “SWC Configured” appears on the screen.
4. Turn ignition off and start vehicle, then test your interface.



(Figure A)

Option #2

1. With the vehicle running, press the **Reset Vehicle Type** button mentioned in **System Configuration**.
2. Refer to **Programming**, step 3, from this point.

If you are having difficulties with the installation of this product, contact our Tech Support line either by phone at **386-257-1187**, or email at **techsupport@metra-autosound.com**. Before doing so, look over the instruction booklet a second time and ensure that the installation was performed exactly as the instruction booklet is stated. Have the vehicle apart and ready to perform troubleshooting steps before contacting Metra/Axxess Tech Support.



® KNOWLEDGE IS POWER

Enhance your installation and fabrication skills by enrolling in the most recognized and respected training program in the industry. Visit www.metrainstitute.com or call 800-354-6782 for more information and take steps toward a better tomorrow.



**Metra recommends MECP
certified technicians**