



# SILVER SPORT *Transmissions*



## HYDRAULIC KIT INSTRUCTIONS FOR GM TKO, TKX, T56, AND T56 MAGNUM

**BEFORE INSTALLING TRANSMISSION IN CAR, YOU MUST CHECK  
THE HYDRAULIC BEARING CUSHION MEASUREMENT!!!**

**SEE PAGE 8 OF INSTALLATION MANUAL FOR INSTRUCTIONS ON  
MEASURING HYDRAULIC BEARING CUSHION. RECORD THIS  
MEASUREMENT FOR FUTURE REFERENCE.**

**DAMAGE WILL OCCUR IF MEASUREMENT IS  
INCORRECT!!!**

The material herein is the intellectual property of Silver Sport Transmissions ("SST") and is to be used by SST customers or their authorized installers for the sole purpose of installing SST-supplied transmissions and related parts. Under no circumstances shall the manual or any portion thereof be copied, duplicated, distributed or incorporated in any written or printed document without the express written approval of Silver Sport Transmissions.

## **SYSTEM DESCRIPTION:**

This system uses a firewall-mounted hydraulic master cylinder with remote reservoir and a combination slave cylinder/release bearing assembly. This combination bearing is called a concentric slave cylinder (CSC) and **it is designed to be in constant contact with the pressure plate fingers**. The CSC is compressed by the pressure plate fingers when at rest. When the clutch pedal is depressed, the master cylinder forces fluid into the CSC, causing it to expand and depress the pressure plate fingers, thereby releasing the clutch.

This system works best with **DOT 4** brake fluid, **even though the reservoir lid says DOT 3**. **DO NOT use DOT 5 brake fluid!** The seals in the CSC are not compatible with DOT 5 fluid, and will be ruined on contact with it. We recommend using a high-performance, extra-high-temp name brand **DOT 4** brake fluid from ATE, Wilwood, or others.

This system is engineered for use with a diaphragm-style pressure plate and is not compatible with some three-finger style pressure plates. It is recommended that you remove the over-center spring (if equipped) from the clutch pedal when using a diaphragm-style pressure plate.

## **KIT CONTENTS**

Please confirm that all parts have been received. The parts contained in your Master Cylinder kit vary by car model, and will include:

- fluid reservoir, hose, and fittings
- mount block, backing plate and gasket
- pushrod extension
- rod end and pedal attachment hardware
- master cylinder
- hardware



**NOTE: PARTS PICTURED ARE EXAMPLES ONLY. THE CORRECT PARTS FOR YOUR PARTICULAR VEHICLE MAY NOT LOOK THE SAME.**

The parts contained in your Slave Cylinder kit are:

- transmission front bearing retainer & locating stud
- combination slave cylinder/release bearing (CSC)
- braided steel hose with bleeder
- 5/16"-18 flat head socket cap screws (4)
- spacer plates (if required for application)

If the hydraulic kit was ordered at the same time as the transmission, then your CSC will be placed on the front of the transmission.



## **DISASSEMBLY**

Remove original clutch linkages, transmission and bellhousing components:



- Fork push rod, clutch pedal push rod assembly
- Z-bar retaining clip, Z-bar, ball stud and bracket assembly
- Fork boot
- Drive shaft
- Shifter Handle and Shift Mechanism (if 3 or 4 speed equipped)
- Transmission and bellhousing
- Throw-out bearing, clutch fork and fork pivot

## **INSTALLATION OPTIONS**

The SST hydraulic system should be installed and then bled on the vehicle in the conventional manner. Bench bleeding should not be done and a vacuum bleeder can be used after the hydraulic system is fully installed on the vehicle.

## **MASTER CYLINDER MOUNTING**

1. From under the hood, locate the factory clutch pushrod hole. On automatic cars, this may be a hole with a rubber grommet or a small sheet metal cover with two screws. On some cars, it is part of the steering column opening in the firewall. If there is a cover over an existing hole, remove the cover. Some vehicles may not have a factory hole in the firewall, but there should be a spot that is contoured for a hole. That spot is usually located below and slightly to the left (driver's side) of the brake master cylinder or brake booster mount, near the steering column.
2. If no clutch rod hole exists in your firewall, measure the diameter of the pushrod hole in the clutch master cylinder mounting block (the side that is against the firewall). Cut a hole of that size in the factory spot on the firewall. Some cars may require elongating the hole due to the angle of the master cylinder.
 



3. From the engine compartment, insert the master cylinder pushrod through the firewall and center the master cylinder pushrod in the hole, keeping the mount block against the firewall. Confirm that the pushrod points toward and reaches the clutch pedal attachment point (see "PEDAL ATTACHMENT" section). Carefully mark the firewall for each of the mounting bolt holes using a transfer punch, center punch or marker. Alternately, you can use the master cylinder backing plate to mark the inside of the firewall (make sure the backing plate is facing the right direction!).

4. The master cylinder must be positioned so that the pushrod moves in and out in a straight line. The master cylinder will not tolerate a side load, and will wear out very quickly if the pushrod is going in at an angle. **Make sure the pushrod is straight in line with the master cylinder!**

#### **CAR-SPECIFIC NOTES:**

- **1967-1969 Camaros and Firebirds:** If there are two holes in the clutch pedal, the pushrod connects to the TOP hole. Occasionally, an extra “wedge” will be required between the firewall and the mount block for the pushrod to line up with the upper hole.
  - **1968-1982 Corvette** requires that the master cylinder be rotated so that the ports on the top are pointed slightly towards the driver’s side in order for the pushrod to be aligned with the clutch pedal.
  - **1964-1972 Chevelle – El Camino – GTO – 442 – GS:** The mount block is installed using factory firewall welded nut location (3). Drill out nut threads to 3/8” hole for attaching mount using kit supplied 5/16” machine screws. Additionally, the firewall has a lip that will need to be trimmed or flattened for the mount block to sit flush.
  - **1964-67 Chevelle – El Camino – GTO – 442 – GS** May need a clutch stop to prevent bottoming out of the master cylinder.
  - **C10 1967-72 TRUCK:** Refer to special instructions **MAG-00420**
  - **C10 1973-87 TRUCK:** Refer to special instructions **MAG-00423**
  - **1967 X-BODY NOVA with collapsible column:** Refer to special instructions **MAG-00424**
  - **1955-1957 Chevrolet:** Refer to special instructions **MAG-00450**
5. Drill a 3/8” diameter hole through the firewall for each marked location. Remove burrs.
  6. Assemble mount block gasket to mount block, then set the master cylinder and mount block assembly to the firewall. See diagram on following page. Assemble 5/16”-18 bolts through the assembly and firewall. On some applications it will be necessary to insert one or more bolts (usually the bottom bolt) from the passenger compartment side of the firewall.
  7. From passenger compartment, assemble backing plate, lock washer and nuts. Align master cylinder, then tighten bolts to 15 ft.-lbs.
  8. Assemble the 90° end of the braided steel line to master cylinder port closest to firewall.
  9. Assemble barb fitting to master cylinder at port located furthest from firewall. Use caution not to over tighten and break fittings.

**CAMARO/FIREBIRD 67-69  
BEFORE INSTALLATION**



**64-72 CHEVELLE  
BEFORE INSTALLATION**

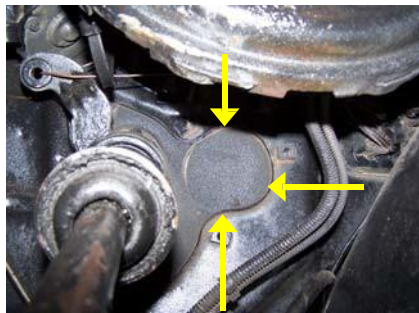

**C1 VETTE**



**CAMARO/FIREBIRD 67-69**



**64-72 CHEVELLE**

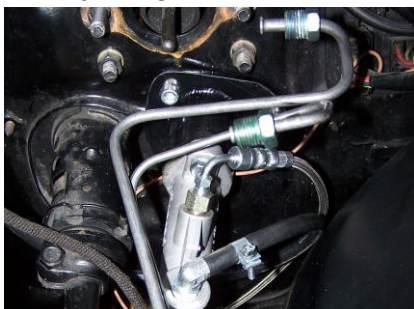

**C2 VETTE**



**Typical Master Cylinder Assembly:**

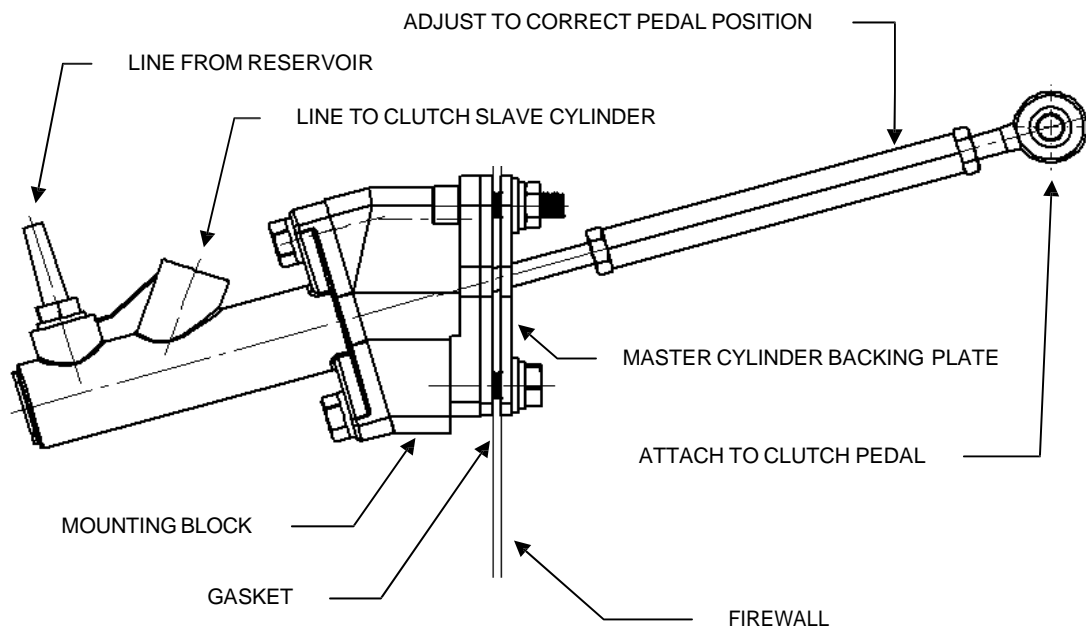

**NOTE:** If you are also installing a SST transmission that requires a new speedometer cable,

**\*\*\* NOW IS A REALLY GOOD TIME TO INSTALL THE NEW SPEEDOMETER CABLE! \*\*\***

On some cars, Corvettes in particular, the back of the speedometer is difficult to reach without disassembling the dash. If you already have the dash apart for the master cylinder or clutch pedal installation, go ahead and install the speedometer cable now.

## **FLUID RESERVOIR MOUNTING**

1. Remove the studs or nuts on the left hand (driver) side of the brake master cylinder.
2. Place reservoir bracket over the two holes or studs in the brake master cylinder, replace the original studs or nuts and tighten completely. Alternatively, the reservoir may be attached directly to firewall.
3. Assemble the reservoir to the bracket using hardware supplied (part # CAA-PACK A).



## **SLAVE CYLINDER MOUNTING**

If your hydraulic clutch system was ordered at the same time as your transmission, the CSC will be mounted on the front of your transmission and you can proceed to the next section “HYDRAULIC BEARING CUSHION MEASUREMENT”. If it was ordered separately, you will need to mount the CSC and retainer onto the transmission following the procedure outlined here.

**NOTE – TKO, TKX:** This procedure involves removal of the transmission’s front bearing retainer and replacement with SST’s custom bearing retainer. **DO NOT allow the input shaft to fall out, roller bearings may then fall into the transmission case, requiring transmission disassembly for removal!**

**NOTE – T56, and Magnum:** On these transmissions, the “bearing retainer” is solely used as a mount for the CSC. It is completely external to the transmission and does not contain the input shaft bearing or oil seal.

1. **TKO,TKX:** Prop up the front of the transmission before removing the bearing retainer. This is to ensure the thrust bearing does not fall down when the bearing retainer is removed.



2. **TKO,TKX:** Remove four (4) bolts holding the front bearing retainer to the transmission (FIG. A).

**FIG. A REMOVE BOLTS**



3. **TKO,TKX:** Remove the front bearing retainer by tapping lightly with a mallet to break it free.  
**TKO/TKX:** **Be sure to keep pressure on the input shaft to prevent it from moving. This is the reason for tilting the transmission in step one. It is very important to not let the input shaft move, otherwise the transmission may need complete disassembly.** (FIG. B).

**FIG. B REMOVE OLD RETAINER**



4. **TKX:** Save the gasket from the bearing retainer. **NOTE:** The gasket must be used in the endplay measurement as the gasket itself is 0.010in thick.

**FIG. C REMOVE GASKET**



5. **TKO/TKX:** If the bearing race came out with the bearing retainer, remove it from the old bearing retainer and insert it into the transmission, taking care not to lose or damage the input shaft shims that are between the bearing retainer and the bearing race (FIG. D). If the race stayed in the transmission, be sure to remove the shims from inside the old bearing retainer. Clean old sealant from the front of the transmission case using a razor blade scraper.

**FIG. C (TKO/TKX ONLY) REMOVE BEARING RACE AND SHIMS**





6. **TKO/TKX:** Place shims into new bearing retainer, using petroleum jelly to hold them in place. Install the thickest shim closest to the bearing race.

**FIG. D (TKO/TKX ONLY) INSTALL SHIMS IN RETAINER**



7. **TKO/TKX:** Position the new bearing retainer without sealer so that the locating stud is at the top (12 o'clock) position and attach it to the transmission using four (4) socket head cap screws (FIG. F & FIG. G). Torque the socket head cap screws to 12-16 lb.-ft. in an "X" pattern.  
**TKX:** Be sure to have the gasket installed as the gasket itself is 0.010in thick and used in the endplay measurement in the next step.
8. **TKO/TKX:** Make sure that the input shaft still turns and does not have any perceptible fore-and-aft movement (endplay). If it does not rotate or has excessive end play, shim and set endplay by doing the following;
- *To measure and set endplay the transmission must be upright and secure on a bench or stand. Secure enough to tap on the input shaft and push up on the output shaft.*
  - *The rubber stopper must be removed out of the output shaft to measure endplay.*



- *Then tap the input shaft down using a rubber mallet to be sure the assembly is seated in the bearings.*
- *Then position a dial indicator to measure the endplay on the input shaft of the transmission. The dial indicator must be fixed to the transmission and not the bench so any flex in the bench will not be added to the measurement. Position the dial indicator so the travel is parallel with input and output shaft to get the best measurement.*
- *Then push up on the output shaft or pull up on the input shaft to measure the amount of endplay in the bearings of the transmission. Then shim accordingly and repeat the measurement process. The spec for the TKO is 0.001 to 0.004 in and the spec for the TKX is 0.001 to 0.005 in of endplay.*

Silver Sport Transmissions has shims available if needed.

9. **TKO/TKX:** Remove the bearing retainer after setting endplay.
10. **TKO/TKX:** Following manufacturer directions, spread a THIN coat of Permatex® Ultra Grey RTV Silicone Gasket Maker #82194 or equivalent on the mounting face of the new bearing retainer.  
**TKX:** Reuse the gasket from step 3.

• **FIG. E (TKO ONLY) SPREAD THIN COAT OF RTV**



11. **ALL:** Position the new bearing retainer so that the locating stud is at the top (12 o'clock) position and attach it to the transmission using four (4) socket head cap screws (FIG. F & FIG. G). Torque the socket head cap screws to 12-16 lb.-ft. in an "X" pattern.  
**TKO/TKX:** Ensure that the oil galley hole, also located at 12 o'clock, lines up with the cutout in the bearing retainer, spread some RTV on the bolts before tightening.  
**MAG:** See figure H

**FIG. F INSTALL NEW RETAINER WITH LOCATING STUD**

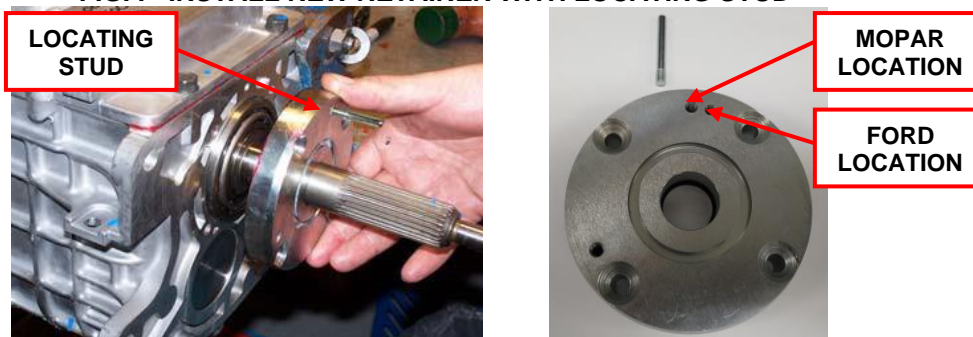

**FIG. G  
RETAINER PROPERLY INSTALLED**

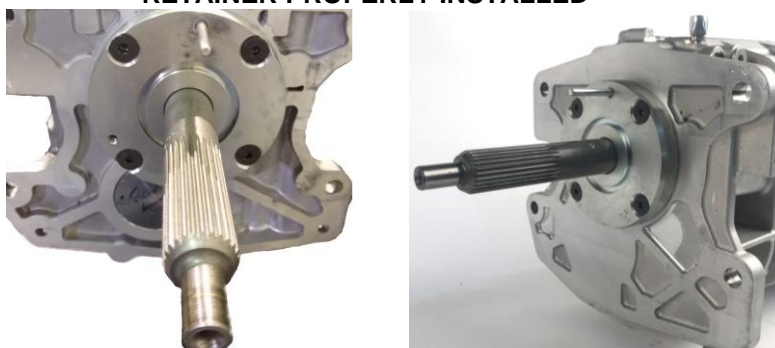

**FIGURE H**  
**MAGNUM BEARING RETAINER**



Install with the locating stud at the 12 o'clock position. Tighten (2) 6mm x1.0 screws to 12 Nm or 106 in lbs.

12. **ALL:** Install bellhousing to engine in order to perform the crankshaft alignment check and make corrections if required per instructions MAA-00101.
13. **ALL:** Remove the bellhousing, install the clutch disk along with the pressure plate.
14. **ALL:** Continue with the remainder of your hydraulic clutch kit installation.

## HYDRAULIC BEARING CUSHION MEASUREMENT

The CSC is designed to be compressed by more than  $\frac{1}{2}$ " by the pressure plate fingers when at rest. The CSC needs a minimum of  $\frac{1}{8}$ " cushion beyond that to allow for clutch disc wear and expansion from heat. Clutch slippage will result if the CSC bottoms out and is partially depressing the pressure plate fingers at rest. The cushion measurement procedure below tells you how far the CSC is away from being completely bottomed out. The acceptable range for the CSC cushion is **between  $\frac{1}{8}$ " (0.125") and  $\frac{3}{8}$ " (0.375")**.

1. With the correct clutch pressure plate and clutch disc mounted and torqued to the flywheel, install the bellhousing to the engine with two (2) bolts.
2. Use a straight edge and a steel rule to measure from the transmission mounting face of the bellhousing to the surface of the clutch fingers that contacts the release bearing. Record this depth measurement ( **X** ). Then, remove the bellhousing.

**FIG. K**

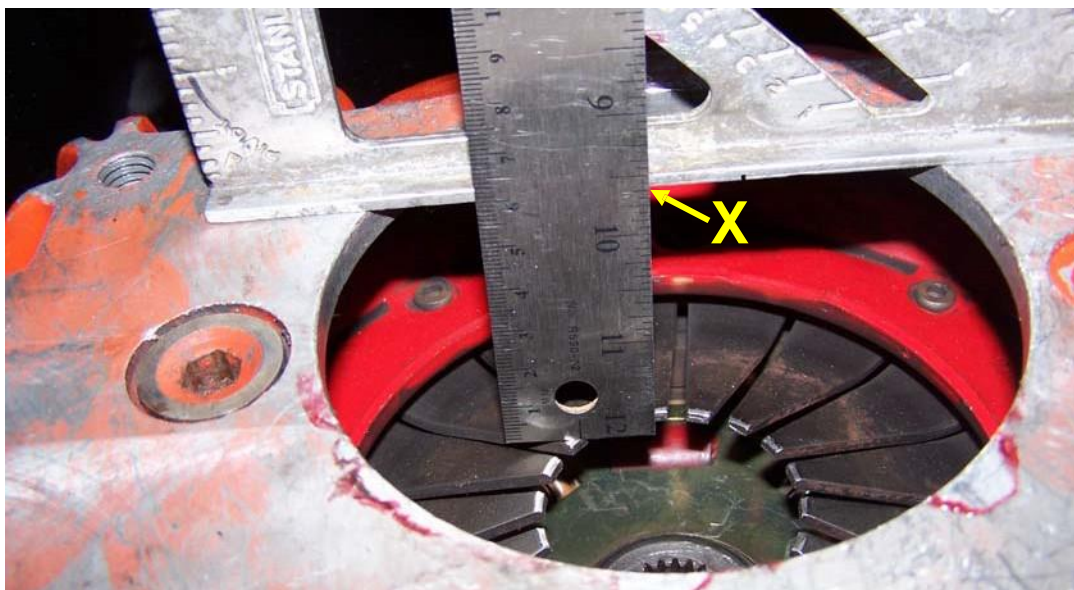

3. Next, with the slave cylinder mounted on the transmission, compress the CSC against its internal spring pressure back towards the transmission. With the CSC compressed to its internal stop (completely bottomed out), hold a straight edge across the face of the throw-out bearing and measure the distance from the face of the bearing to the bellhousing mounting face of the transmission. Record this dimension ( **Y** ).

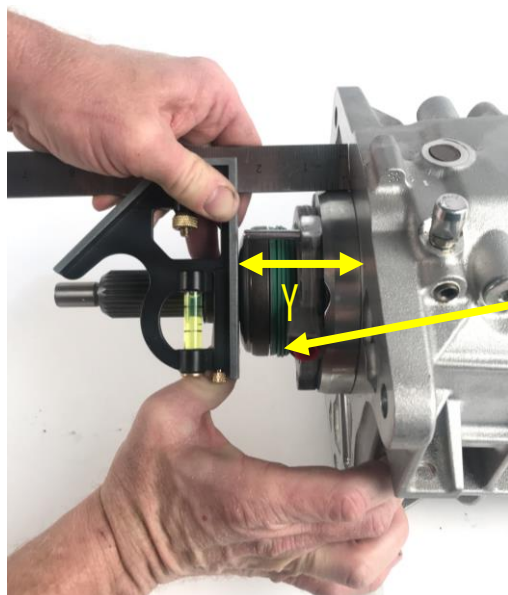

**MEASURE FROM THE FRONT OF THE TRANSMISSION CASE TO THE SURFACE OF THE FULLY COLLAPSED BEARING FOR YOUR "Y" DIMENSION.**

**BEARING FULLY COLLAPSED**

4. Your depth measurement ( **X** ) minus the compressed bearing height ( **Y** ) is your bearing cushion:

$$(X) - (Y) = \text{CUSHION}$$

5. The resulting cushion dimension should be **at least 1/8" (0.125")**, but no more than **3/8" (0.375")**. Anywhere within this range is acceptable. There is no advantage or disadvantage to being at the upper or lower end of the range, or even in the middle. The CSC will function exactly the same way, no matter where it lies within this range.

**If your cushion measurement is outside of this range, you will need one or more spacers to adjust the position of the CSC.**

Call [Silver Sport Transmissions](#) to obtain spacers if needed. **Damage WILL result from an incorrect cushion dimension.**

If your cushion measurement is **MORE** than 3/8", you will need one or more CSC spacers to move the CSC closer to the engine block. The spacers are 1/4" thick, and are mounted between the CSC and the input shaft bearing retainer. This is somewhat common with LS series engines.

**CSC SPACER**



**INSTALL SPACERS IF NEEDED**



If your cushion measurement is **LESS** than 1/8", you will need a bellhousing spacer to move the transmission and CSC further away from the engine block. The spacer is 1/4" thick, and gets sandwiched in between the bellhousing and the transmission. You can only use one bellhousing spacer. If you need more than 1/4" to get your cushion within specs, you may have to resurface the flywheel, change to a thinner flywheel, or change to a different clutch.



**BELLHOUSING SPACER**

**\*\*\*\*\* NOTE:** The bearing cushion will also need to be re-measured and recalculated after **resurfacing or replacing the flywheel, or changing the bellhousing, engine, or clutch.** Different clutches have different stack-up heights, and a scattershield is often deeper than a factory GM bellhousing.

## **TRANSMISSION MOUNTING**

1. Attach rubber boot to the bellhousing clutch arm window opening as shown below.
2. Place bellhousing onto the transmission while it is setting across a box. Install two (2) mounting bolts to align bellhousing with the transmission mounting face.

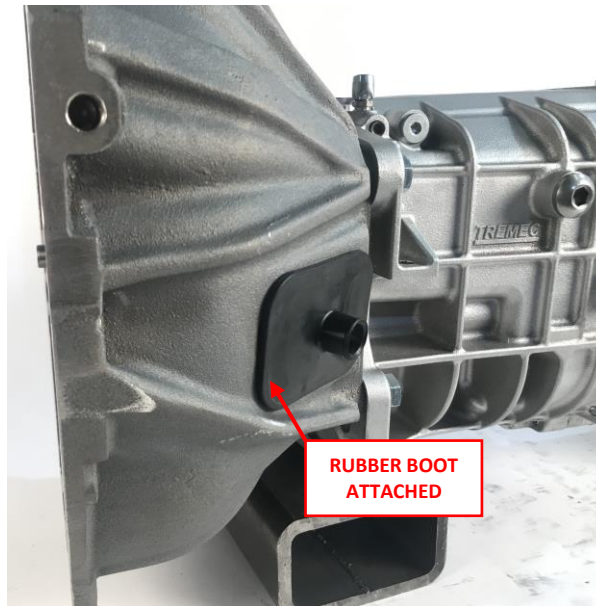

3. Insert hydraulic line from outside of bellhousing with the bleeder pointing down and start threading into the throw-out bearing.

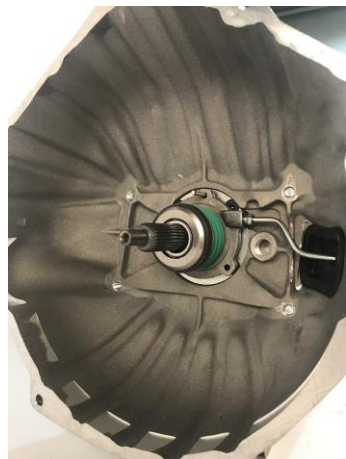

**NOTE: Be very careful not to cross-thread the fitting when doing this!**

4. Tighten the line with it centered in the opening of the rubber boot.



5. Remove the bellhousing with the hydraulic bearing and assembled line attached.
6. Install the bellhousing with the attached hydraulic bearing and assembled line to the engine. Torque the bolts to factory service manual specifications. Apply pressure to the back side of the hydraulic bearing to insert the passenger-side mounting ear inside the bellhousing pilot hole as shown below.

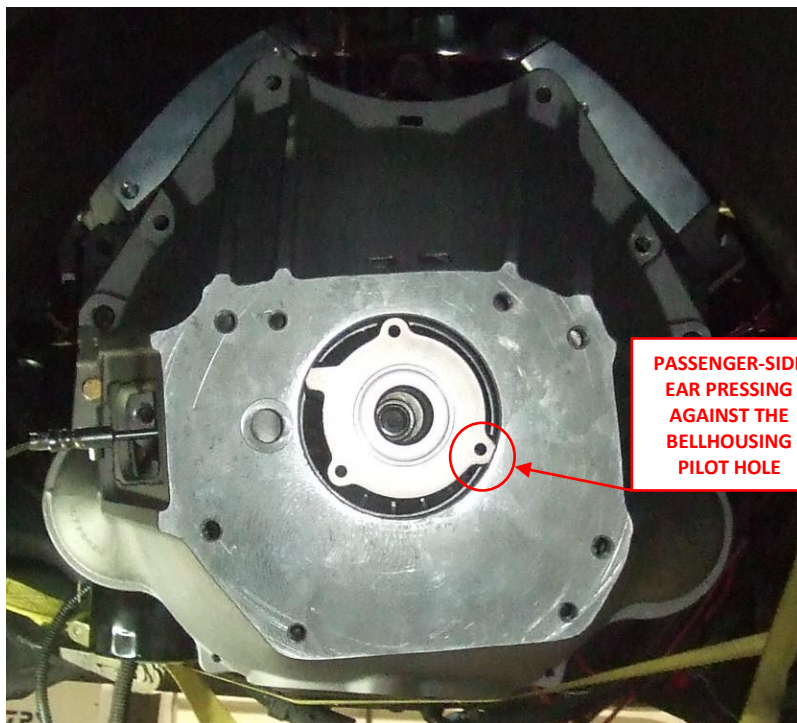

- Align the stud with the bearing upper mounting ear hole and install the transmission as shown below. Once the input shaft enters the hydraulic bearing, the bearing will align itself with the bellhousing pilot hole and slide into place.

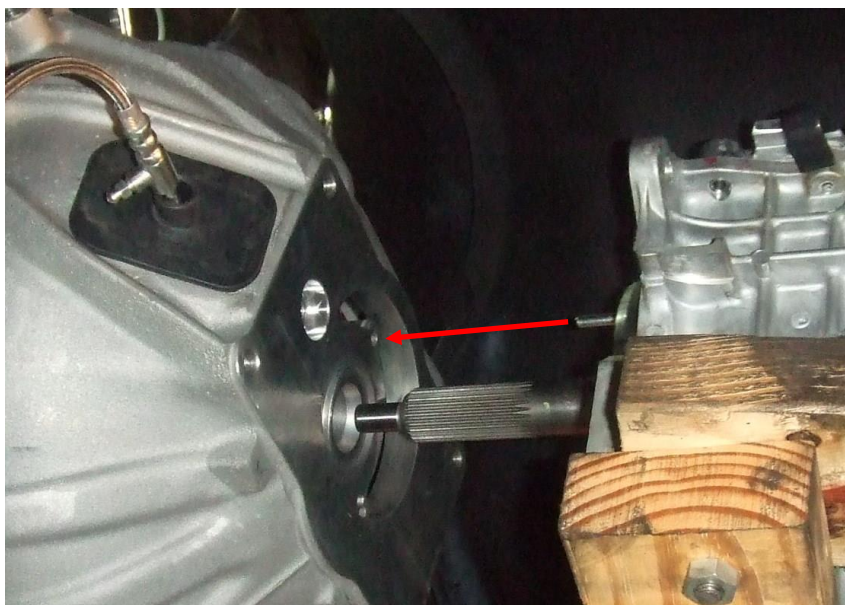

**NOTE: You may have to slightly twist the transmission left or right in order to align the stud with the hydraulic bearing. If you are not using a transmission jack, obtaining assistance from another person might be needed.**

### **HYDRAULIC LOW PRESSURE HOSE MOUNTING**

- Run the rubber supply hose from the bottom of the reservoir nipple to the barb fitting in the clutch master cylinder, and determine the exact length for the supply hose. The hose should be neither tight nor excessively loose, and should clear all moving steering gear and exhaust components. Take care to prevent foreign debris from entering hose.
- Cut the line to desired length, ensure that no foreign matter is in the hose. Then, loosely assemble hose clamps.
- Install hose to the master cylinder, then to the reservoir. When installing hose to the reservoir, hold the top of the reservoir to prevent overloading and damaging the mounting ears.

### **HYDRAULIC HIGH PRESSURE HOSE MOUNTING**

- After bolting the transmission/bellhousing unit to the engine, attach the remaining end of the braided steel line to the clutch master cylinder and tighten. Use caution not to over tighten and break the fitting.
- Final tighten all transmission mounting bolts (4 pcs).
- Inspect the supply line inside bellhousing and confirm the hoses have ample clearance to the rotating clutch plate. It is extremely important that the hydraulic clutch hose **DOES NOT** come into contact with the clutch plate, as serious damage could result.

**NOTE: DOT 4 BRAKE FLUID STRONGLY RECOMMENDED, (even though the lid says DOT 3).  
SHIELD HYDRAULIC LINES FROM HEAT, ESPECIALLY NEAR EXHAUST.**



## PEDAL ATTACHMENT

**NOTE:** If you are changing from a three (3) finger style pressure plate to a diaphragm style pressure plate you should also remove the clutch pedal over center spring, if equipped with one. Failure to remove the over center spring could result in the spring holding the clutch pedal down during normal operation. The over center spring will also tend to hold the pedal down while performing the bleeding operation, until the system is bled enough to return the pedal. An over center spring is not recommended for use with a diaphragm-style pressure plate, and the hydraulic system is not compatible with some three-finger style clutches. We strongly recommend a diaphragm-style pressure plate.

### **Shoulder Bolt Attachment** (uses part # CAA-PACK F)

1. If there is more than one hole in your clutch pedal arm, in most cases you will use the hole that the factory original pushrod would have used. If you are not sure which hole this is, please consult a factory service manual. On some applications, the pushrod actually connects to a bracket that is welded or bolted onto the pedal. Again, consult a factory service manual if needed.

**NOTE: 1967-1969 Camaro and Firebird – Use the UPPER hole if there is more than one hole**

**NOTE: 1955-1957 Chevrolet – Remove the bracket from the clutch pedal, attach the 1-1/2” long aluminum spacer to the lower hole, and connect the rod end to the spacer.**

2. Adjust rod end position to achieve proper pedal height with master cylinder pushrod **EXTENDED ALL THE WAY OUT**. If the master cylinder is not fully extended when the pedal is at rest, the master cylinder can be difficult to bleed **and can overextend the CSC and cause it to fail**. Make sure the pushrod travels in and out of the master cylinder in a straight line and does not contact the firewall, mount block, or backing plate at any point during its travel. When desired pedal height is achieved, tighten locknuts on pushrod and rod end.
3. Assemble shoulder bolt through rod end on master cylinder pushrod.
4. Assemble spacer sleeve to shoulder bolt, if needed. It may go in between the rod end and clutch pedal OR on opposite side of clutch pedal from the rod end, if it lines up better when it is against the pedal. Attach with washer and lock nut. Tighten to 6 ft.-lbs.
5. Note: You may have to loosen the brake light switch bracket to insert the bolt. In some applications, a small adjustment of the switch position may be required to clear the bolt head.
6. **DO NOT** depress the pedal any more than necessary before fluid is added to the system.  
**DOT 4 BRAKE FLUID STRONGLY RECOMMENDED.**

### **Clevis-type Attachment**

1. Adjust rod end position to achieve pedal in home position with master cylinder pushrod fully extended. When desired position is achieved, tighten locknut on pushrod.
2. Install rod end, flat washer, then spring clip retainer or cotter pin.

**SHOULDER BOLT TYPE**



**CLEVIS TYPE**



## HYDRAULIC FLUID FILL & BLEED – ON CAR

You will need two people to bleed this clutch system when installed on the vehicle. Use caution to prevent brake fluid from contacting paint, as damage will likely occur. If your vehicle has an over-center spring installed, it will tend to hold the clutch pedal to the floor until the system is bled enough to return the pedal itself. Remove reservoir cap from the reservoir.

1. Fill the reservoir full with **DOT 4 brake fluid**. During the next steps check regularly to **make sure that the reservoir does not run out of fluid**. If this happens you will have to start the process over.
2. Open the bleeder screw to allow air to escape from the system. Give the fluid a few minutes to make its way down to the bleeder screw, while watching the fluid level in the reservoir and refilling as necessary. Allow fluid to drip from the bleeder screw into a suitable container.
3. It may be necessary to prime the master cylinder by removing the high pressure hose at the master cylinder and block the fitting outlet to draw fluid into the cylinder when stroking the pedal. When the cylinder is primed, reattach the pressure line and continue the bleeding procedure. Take care not to spill brake fluid on any painted surfaces.
4. When the drip becomes a steady stream, close the bleeder screw. Refill the fluid reservoir. Open the bleeder screw slightly and have your helper depress the pedal **slowly**. Close the bleeder as soon as the pedal reaches the floor. Then have your helper **slowly** release the pedal. **Pressing or releasing the pedal too quickly will cause brake fluid to squirt from the top of the reservoir**. The pedal may need to be manually pulled up from the floor during these steps. Repeat this process several times, refilling the reservoir every 3 strokes or so.
5. When the bleeder stops spitting air, close and tighten the bleeder screw. Pump the pedal several times to check for proper feel. Repeat the process if the pedal is not firm throughout its travel, or if it seems that the clutch is not releasing fully. Make sure that the master cylinder pushrod is traveling its full stroke of 1.4" (1-3/8") and that **the master cylinder is fully extended when the clutch pedal returns to its home position (no tension on the pushrod with the clutch pedal all the way up)**.
6. **VACUUM BLEEDING PROCEDURE:** If bleeding proves difficult for one reason or another, a manual vacuum bleeder can be used to draw a vacuum on the reservoir and thereby the entire system and pull trapped air into the reservoir. With the rubber baffle removed from the reservoir and the cap installed, apply vacuum to the vent hole in the center of the cap. You may try stroking the pedal while vacuum is being applied. Repeat until the system is bled. It may take 20-30 minutes or even more in order for the vacuum method to get all the air out of the system.
7. Upon successful bleeding, fluid level will need to be lowered to approximately 1/3 full. Excess fluid may be removed from the reservoir by siphoning with a hand-held vacuum pump or with a spoon or medicine cup. Reinstall rubber baffle and cap.
8. Inspect for leaks, and replace the bellhousing inspection cover.
9. Check fluid level and add if necessary after the first test drive or after vehicle sits overnight.

**NOTE: It may be necessary to bleed the clutch again after minimal use, as operation may dislodge some trapped air.**

## INSPECTION AND TESTING

**USE EXTREME CAUTION WHEN TESTING CLUTCH RELEASE SYSTEM.  
DO NOT TEST IN HIGH TRAFFIC OR PUBLIC AREAS.**

### ENGINE-OFF TEST

With the parking brake set, test the release and engagement of the clutch mechanism. Check for the following:

1. Clutch pedal completely up at its home position when released, and that the **master cylinder pushrod is fully extended** when the pedal is all the way up.
2. Clutch pedal does not hit brake lamp bracket or other bracket.
3. Low resistance for initial travel when depressing clutch pedal. Clutch resistance increasing at 1/3 of full stroke and remaining approximately constant through full travel to the floor.
4. Clutch pedal travel to floor without over-travel of clutch plate. Over-travel is characterized by a sudden hard pedal. This should not be a problem if the "Hydraulic Bearing Cushion Measurement" was accurately made.
5. Clutch pedal travel to floor without bottoming out hydraulic bearing. Bottoming out is characterized by a sudden high pressure required to exert further pedal stroke. If this condition occurs, damage to the master cylinder seals or slave cylinder may result from continued operation. **NOTE: The hydraulic slave cylinder has approximately 7/8 inch total stroke, minus the cushion that was measured earlier. Most clutches release within 1/2 inch travel.**
6. Smooth system operation with no abnormal noises.

### ENGINE-ON TEST:

Hold brake, place transmission in neutral, start engine. Achieve idle of 1000 rpm or less.

1. Depress clutch pedal.
2. Ease shifter into first gear. **CAUTION:** If grinding occurs, pull back to neutral and stop engine. Repeat bleeding process and verify that the master cylinder pushrod is moving a full 1.4" (1-3/8").
3. Slowly release clutch pedal while maintaining brake pedal pressure. Confirm engine is being loaded as clutch pedal is released.
4. Repeat test step 1-3 through all gears, including reverse. **NOTE for TKO ONLY: Reverse is not synchronized in the TKO 5 speed, and grinding may occur. This can be eliminated through placing shifter in a forward gear immediately before proceeding to reverse.**

## **CARE AND MAINTENANCE**

Your SST hydraulic clutch actuator system is designed to give you years of trouble-free service. In order to maximize the life of the system:

- Periodically check fluid level, hose clamps and hoses for damage.
- Flush the hydraulic fluid every 2 years with new, clean **DOT 4** brake fluid.

## **SYSTEM SPECIFICATIONS**

Master cylinder: Bore = 0.750"  
Stroke = 1.400"

CSC: Stroke = .910" total available travel

Fluid: DOT 3 brake fluid is acceptable, **DOT 4** is strongly recommended. **DO NOT USE DOT 5 FLUID.**

## **ACCESSORY ITEMS**

The following accessory items will enhance your installation:

- SST Cast Titanium-Aluminum Chevrolet Bellhousing. New casting features super high strength aircraft alloy, lightweight 15lbs, precision CNC machining for accurate alignment of transmission to crank bore, 168 tooth flywheel mounting. For both 4 & 5 speeds.
- Clutches/Flywheels – We carry a full range of clutches, and both billet steel and aluminum flywheels.
- SST Reproduction Pedal Assemblies – New precision made pedal conversion allow easy conversion from automatic, or quality replacement parts for restoration.
- SHIFTER HANDLES – Full line of 4, 5 & 6 speed shifter handles and shift balls.

### **CONTACT INFORMATION**

SILVER SPORT TRANSMISSIONS  
2250 STOCK CREEK BOULEVARD  
ROCKFORD, TENNESSEE 37853-3043

Phone: (865) 609-8187  
Toll Free: (888) 609-0094  
Fax: (865) 609-8287

[WWW.SHIFTSST.COM](http://WWW.SHIFTSST.COM)

*SILVER SPORT TRANSMISSIONS IS DEDICATED TO YOUR SATISFACTION AND ENJOYMENT OF THIS PRODUCT. PLEASE SEND US PICTURES OF YOUR CAR ALONG WITH A TESTIMONIAL OF HOW YOU RATE THIS PRODUCT. WE WILL BE POSTING MANY CUSTOMER FEEDBACK LETTERS AND PICTURES ON OUR WEBSITE AND BROCHURES.*

**ENJOY YOUR SILVER SPORT  
TRANSMISSION SYSTEM!**

## TROUBLESHOOTING GUIDE

If you are having any sort of problem with the hydraulic system, the first step is to **review the “Hydraulic Bearing Cushion Measurement”** procedure starting on page 7, and verify that you have the correct amount of cushion (1/8” – 3/8”). Do this before going ANY further into the installation.

### DIFFICULTY BLEEDING, FLUID WILL NOT FLOW, CAN'T GET ALL THE AIR OUT, CLUTCH WON'T FULLY RELEASE:

Review the bleeding procedure. Verify:

- That the master cylinder pushrod is **fully extended** when the clutch pedal is all the way up. If there is any tension on the pushrod and the pushrod does not come all the way out, it can close off the fill port in the master cylinder, and fluid will not be able to flow from the reservoir to the master cylinder. **This condition can also cause the CSC to overextend and fail.**
- That you are getting a full 1.4” (1-3/8”) of stroke out of the pushrod itself. If not, then the pushrod extension may need to be adjusted, the master cylinder may need to be repositioned on the firewall, or it may be that the pushrod needs to be connected to a different spot on the pedal. If you change the mount position or connection point, make sure that the pushrod still ends up traveling in a straight line into the master cylinder.
- Make sure the firewall is not flexing. If you measure at the pedal arm and the pushrod is moving 1-3/8”, but the firewall is flexing 1/4”, then you are actually only getting 1-1/8” of stroke.
- If you are using a reservoir that did not come from us, make sure the lid is vented. Some aftermarket reservoirs do not have a vented lid, and this will prevent the system from self-adjusting or bleeding properly.
- If you are using a master cylinder that didn't come from SST, it may be too small. Any master cylinder you use must displace nearly the same amount of fluid as ours in order for it to work properly. Our master cylinder has a 0.750” bore and a 1.4” stroke. If you go with a larger diameter bore, it will INCREASE the amount of pedal effort required and require a shorter stroke; a smaller bore will DECREASE the pedal effort, but require a longer stroke.
  - A master cylinder with a 5/8 (0.675)” bore needs a 2.1” stroke to be compatible with our CSC
  - A master cylinder with a 7/8 (0.875)” bore needs a 1.1” stroke to be compatible with our CSC
- Other, non-hydraulic problems can prevent the clutch from releasing. If the clutch disc is too large in diameter for the pressure plate, it could be pinched. The tip of the input shaft could be bottomed out in the crankshaft. The clutch disc could have gotten contaminated and could be stuck to the pressure plate or flywheel. The pilot bearing could be frozen.

### HIGH PEDAL EFFORT

- The most common cause for a high pedal effort is having the pushrod connected too low on the pedal. Moving the pushrod connection point up closer to the pedal pivot point will reduce the pedal effort. Doing this may also require that the master cylinder be repositioned.
- If the pushrod is not straight in line with the master cylinder, that will also cause increased pedal effort and will wear the master cylinder prematurely.
- Make sure there are no kinks in the braided steel line.

## BLACK FLUID

- If the fluid in the system turns black or has debris in it, that typically means that the pushrod is not straight with the master cylinder. If the pushrod is at an angle to the master cylinder, this will cause the master cylinder to wear prematurely. The black specks are actually oxidized aluminum particles.

## CLUTCH WON'T DISENGAGE WHEN HOT, PEDAL GETS SPONGY

- If the fluid gets too hot, it can boil and create bubbles in the system. Route hydraulic lines as far away from the exhaust as possible, and shield them if needed. Make sure you are using **fresh hi-temp DOT4 brake fluid** in the system. Brake fluid that has been sitting on the shelf for a long period of time will absorb moisture from the atmosphere, even if the container is closed. Moisture in the fluid can lower the boiling point significantly.

## CLUTCH SLIPS OR DISENGAGES PREMATURELY

- You may be “upside down” on the hydraulic bearing cushion measurement. If your “X” measurement is smaller than your “Y” measurement, this will give you a negative cushion, and the pressure plate fingers are actually being depressed all the time. Double check your hydraulic bearing cushion measurements and your math.

## CSC FAILURE, CSC LEAKING FLUID, CSC HAS COME APART

- Your hydraulic bearing cushion measurement is likely too big (greater than 3/8”) OR the master cylinder pushrod is adjusted too tight and is not allowing the master cylinder to return to the fully extended position. Recheck your cushion measurements and your math, as well as the pushrod adjustment. The CSC is not able to be rebuilt. It is an OE part that we modify so that it will work with our transmissions.

**If you are still having issues, call Silver Sport Transmissions' Customer Service and Technical Support at (888) 609-0094.**