



INSTALLATION INSTRUCTIONS



SYSTEM D-FIT WITH MUFFLER GM | PART NO. 19534

BILL OF MATERIALS:

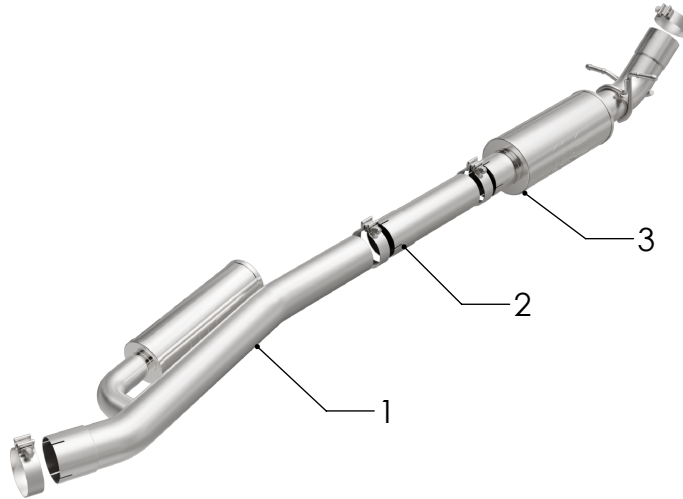

- 1. Inlet Resonator Assy
- 2. Extension Pipe
- 3. Outlet Resonator Assy



WEAR SAFETY GLASSES



READ INSTRUCTIONS THOROUGHLY BEFORE INSTALLING PRODUCT



SPRAY LUBRICANT

To ease removal of existing exhaust components (especially on older vehicles) spray penetrating lubricant on all fasteners and hangers/insulators that will be loosened or removed and let soak before disassembly.

HARDWARE KIT:

- 1. [4] 3.50" Clamp

SHOP SUPPLIES:

MINIMUM REQUIRED TOOLS:



Saw (Or Other Cutting Tool)



15 mm



Hanger Tool (Or Pry Bar)

MAGNAFLOW RECOMMENDS PROFESSIONAL INSTALLATION ON ALL THEIR PRODUCTS



WARNING: When working on, under, or around any vehicle exercise caution. Please allow the vehicle's exhaust system to cool before removal, as exhaust system temperatures may cause severe burns. If working without a lift always consult vehicle manual for correct lifting specifications. Always wear safety glasses and ensure a safe work area. Serious injury or death could occur if safety measures are not followed.

ATTENTION: Always install any supplied band or U-bolt clamps to the proper torque specifications of 40-45 ft-lb for band clamps and 30-35 ft-lb for U-bolt clamps. Over tightening will result in the clamps breaking and will NOT be warranted by MagnaFlow.

MAGNAFLOW: 1901 Corporate Centre Dr - Oceanside, CA 92056 | 1(800)990-0905
Technical Support: 1(800) 959-9226 | Email: moreinfo@magnaflow.com

INSTALLATION INSTRUCTIONS

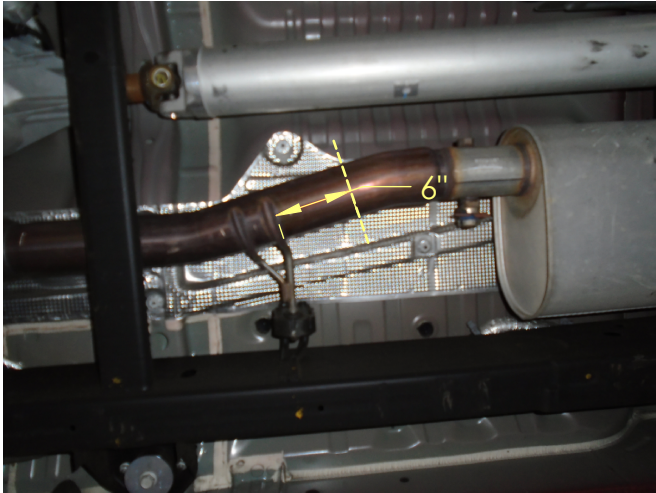

Step 1. The muffler section will need to be removed from the OEM exhaust system. Using a Sawzall or similar cutting tool cut the exhaust pipe 6" rearward of the welded hanger in front of the muffler.

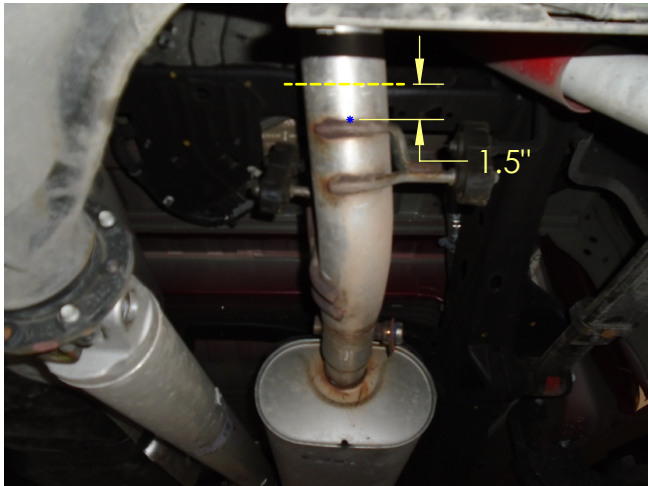

Step 2. Next cut the exhaust rearward of the muffler 1.5" behind the welded hanger. Disengage the welded hanger on the muffler from the rubber insulators. Remove the muffler section. Deburr the sharp edges from the cut ends. You are now ready to install your new MAGNAFLOW system.

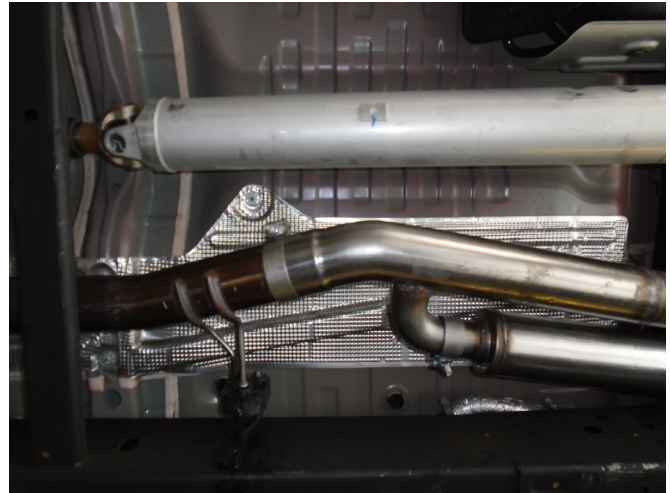

Step 3. Begin installation by slipping the inlet of the Inlet Resonator Assembly over the cut OEM outlet pipe. Secure using the supplied band clamp. Keep all clamps loose until the final assembly is complete to allow for adjustment.



Step 4. Install the Outlet Resonator Assembly by attaching the inlet pipe to the outlet of the Inlet Resonator Assembly. Loosely secure using the supplied band clamp.

INSTALLATION INSTRUCTIONS

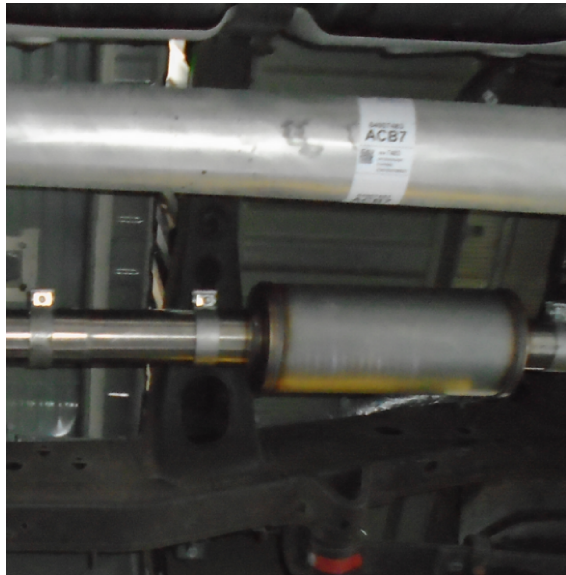

Step 5. If vehicle is a 6.5' Bed, install the 12" extension pipe before the Muffler. If it isn't, ignore this step.

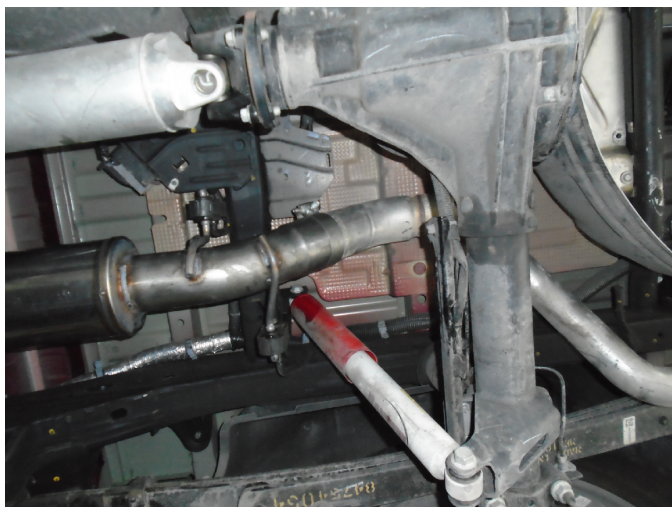

Step 6. Slip the Outlet Resonator exit pipe over the cut OEM rear pipe. Loosely secure using the supplied band clamp. Engage the welded hangers to the rubber insulators.

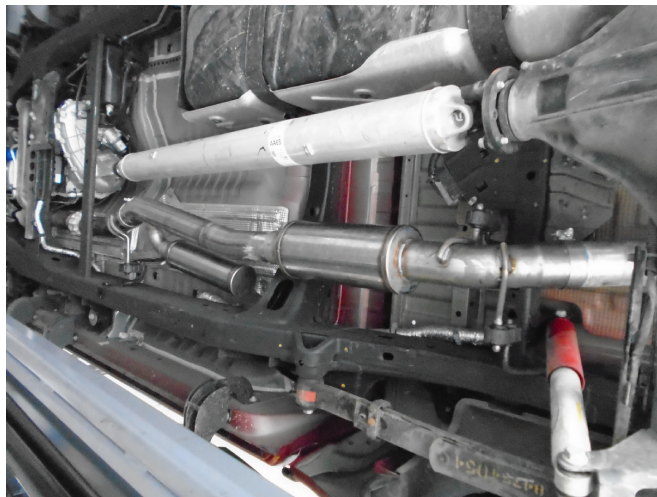

Step 7. With the new MAGNAFLOW system in place all loose band clamps can now be tightened. Your installation is complete.