



INSTALLATION INSTRUCTIONS



2018 JEEP WRANGLER 2.0L | PART NO. 19438

BILL OF MATERIALS:

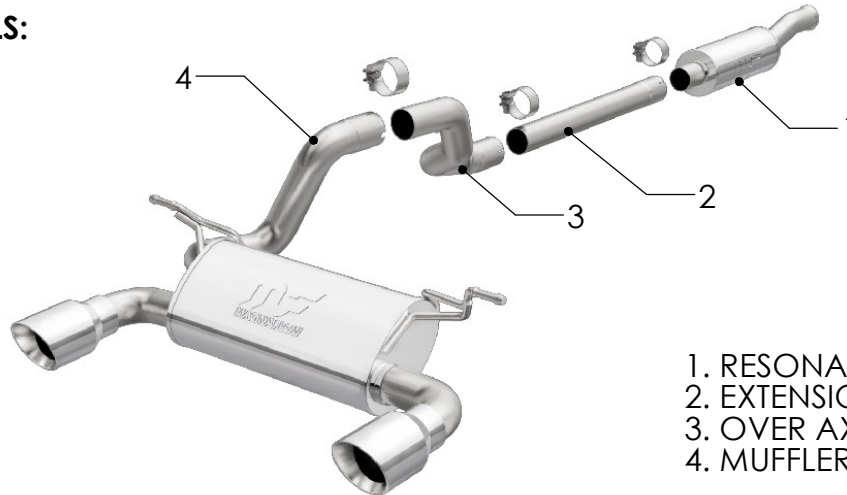

- 1. RESONATOR ASSEMBLY
- 2. EXTENSION PIPE
- 3. OVER AXLE ASSEMBLY
- 4. MUFFLER ASSEMBLY



WEAR SAFETY GLASSES



READ INSTRUCTIONS THOROUGHLY BEFORE INSTALLING PRODUCT



SPRAY LUBRICANT

To ease removal of existing exhaust components (especially on older vehicles) spray penetrating lubricant on all fasteners and hangers/insulators that will be loosened or removed and let soak before disassembly.

HARDWARE KIT:

- 1. [3] 2.50" Clamp

MINIMUM REQUIRED TOOLS:



15mm



Hanger Tool (Or Pry Bar)

MAGNAFLOW RECOMMENDS PROFESSIONAL INSTALLATION ON ALL THEIR PRODUCTS



WARNING: When working on, under, or around any vehicle exercise caution. Please allow the vehicle's exhaust system to cool before removal, as exhaust system temperatures may cause severe burns. If working without a lift always consult vehicle manual for correct lifting specifications. Always wear safety glasses and ensure a safe work area. Serious injury or death could occur if safety measures are not followed.

ATTENTION: Always install any supplied band or V-band clamps to the proper torque specifications of 40-45 ft-lbs for band clamps and 70 in-lbs for V-band clamps. Over tightening will result in the clamp breaking and will NOT be warranted by MagnaFlow.

MAGNAFLOW: 1901 Corporate Centre Dr - Oceanside, CA 92056 | 1(800)990-0905
Technical Support: 1(800) 959-9226 | Email: moreinfo@magnaflow.com

INSTALLATION INSTRUCTIONS

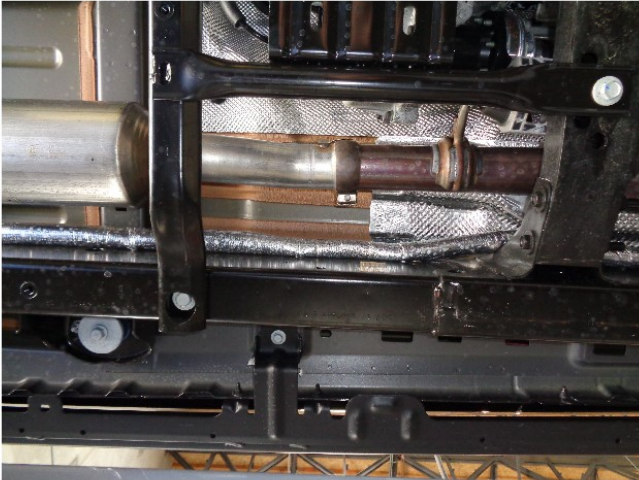

Step 1. Begin removal of the OEM exhaust system by loosening the clamp attaching the exhaust to the catalytic converter.

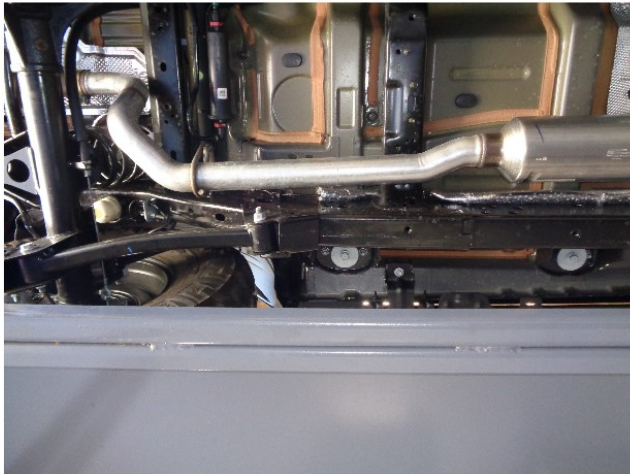

Step 2: With the system supported, working front to rear disengage the hangers from rubber insulators and remove the OEM system. Do not discard or damage the clamp or rubber insulators as they will be used to install the new system.

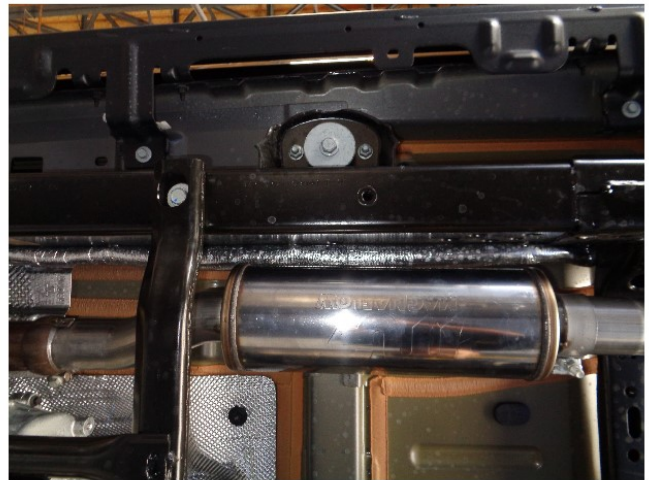

Step 3: Begin installation of your new MAGNAFLOW system by attaching the Resonator Assembly to the catalytic converter outlet using the OEM clamp. Engage the welded hanger to the rubber insulators. Keep all fasteners and clamps loose until final adjustment.

INSTALLATION INSTRUCTIONS

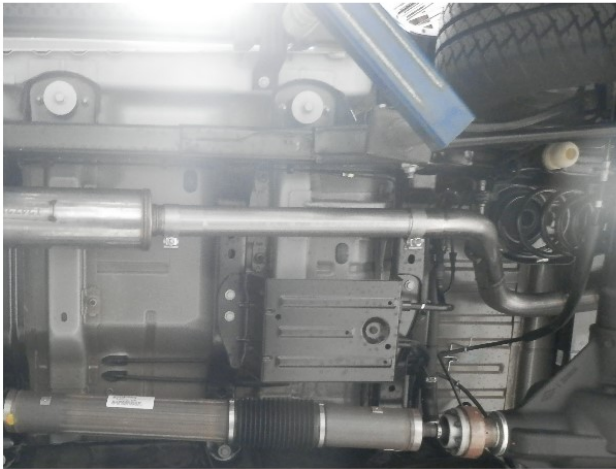

Step 4: The included Extension Pipe is required for the four door model only. It is to be installed between the Resonator Assembly and the Over-Axle Pipe. If you have the two door model this pipe may be discarded.

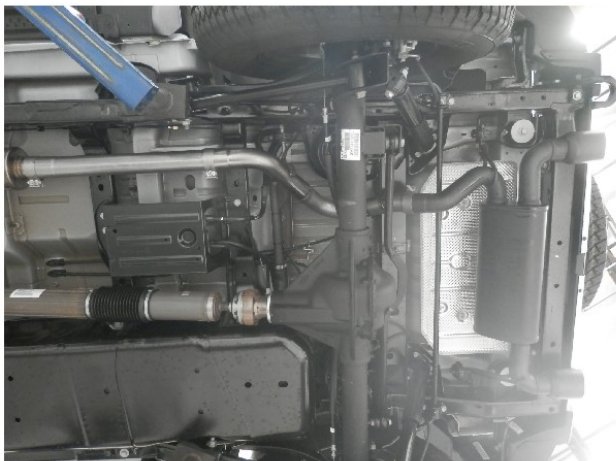

Step 5: Next loosely install the Over-Axle and Muffler Assemblies using the supplied clamps. Locate all welded hangers to the rubber insulators.



Step 6: Once a final position has been chosen for the new exhaust system, evenly tighten all clamps from front to rear using the torque specifications on page one of these instructions. Inspect all fasteners after 25-50 miles for operation and re-tighten if necessary.