



DESTROYER SERIES

JK JEEP

**REAR BUMPER
+ TIRE CARRIER**

INSTALLATION INSTRUCTIONS

STEP 1 :

**GATHER YOUR TOOLS
AND LAY OUT YOUR PARTS...**

Tools Required:

- 16mm socket
- 3/4" socket
- 1/4" socket
- 5/32" Allen wrench
- ratchet
- ratchet Extension
- 3/4" wrench
- tape measure
- floor jack or car jack



***PLEASE READ THROUGH
THE INSTRUCTIONS BEFORE
BEGINNING ANY PART OF THE
INSTALLATION PROCESS***

Web File:

<http://lodoffroad.com/assets/pdfs/JK074DTCDINS.pdf>

Youtube Video:

<https://www.youtube.com/watch?v=RSFGz1zTfks&t=31s>



BUMPER + TIRE CARRIER KIT CONTENTS

Hand Tools Required:

- 5/16" socket
- 7/16" socket
- 5/8" wrench
- 11/16" wrench
- 3/4" wrench
- 1 1/2" socket**
 - ratchet
- ratchet Extension
 - 5/16" wrench
 - 7/16" wrench
- drill with 1/2" drill bit
- grease

required, purchase at local auto store

TIRE CARRIER

Ball stud included in thumb latch - remove to install in door plate

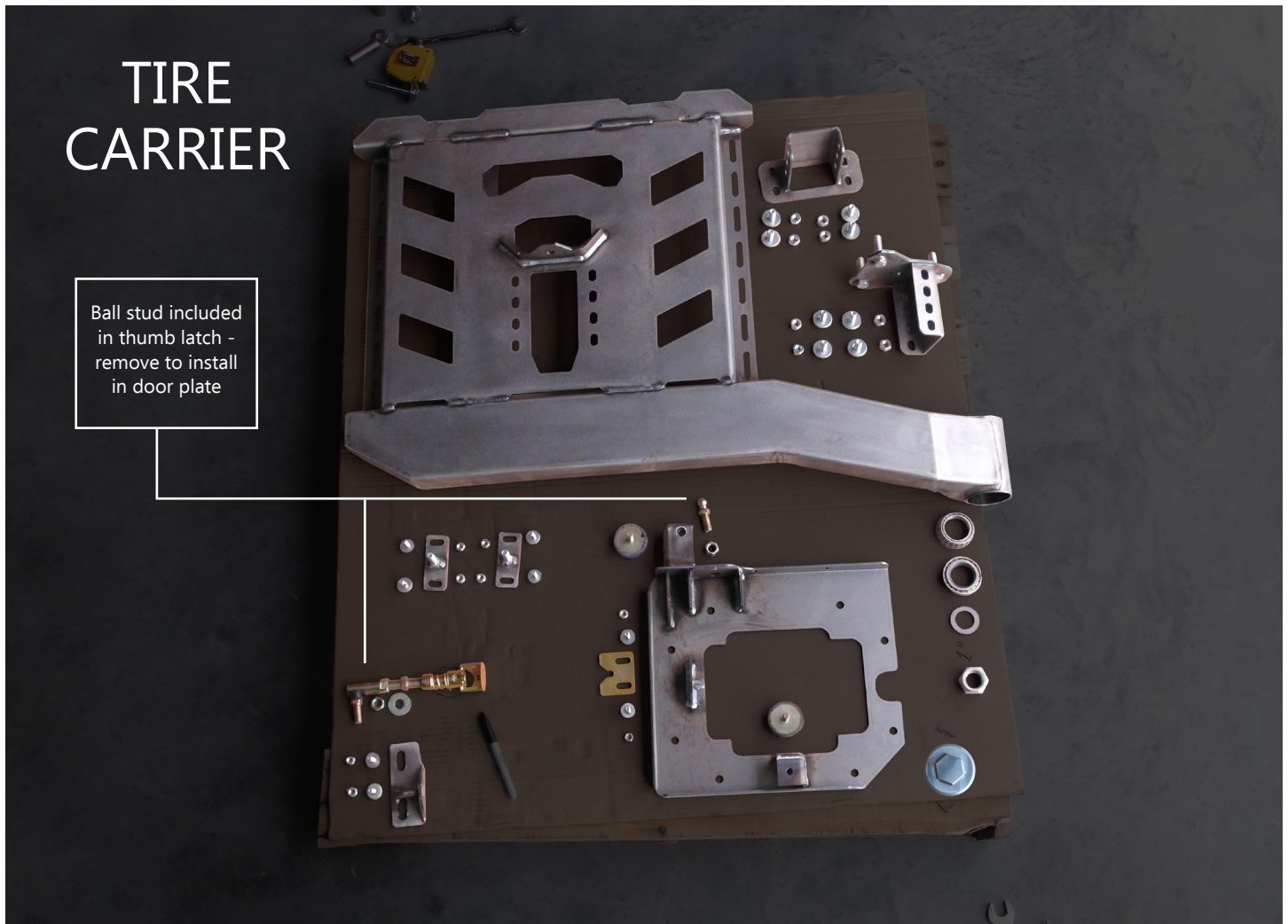

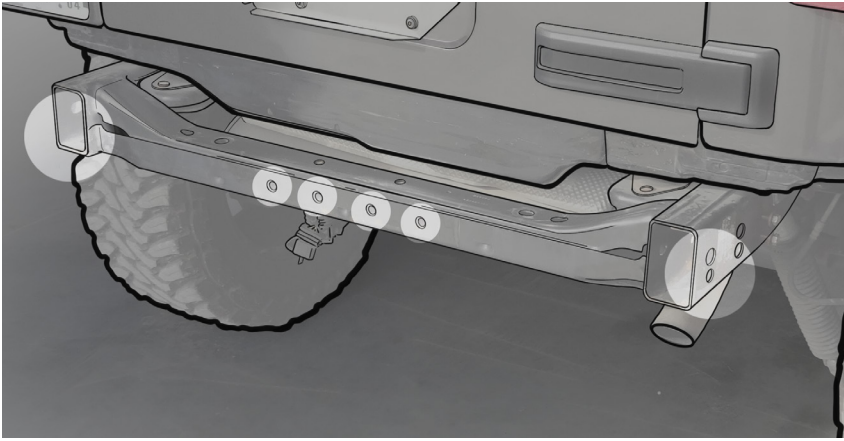

STEP 1 :

Before beginning the installation, there will be 6 locations that require drilling through the cross members.

Use a 1/2" drill bit for drilling these.

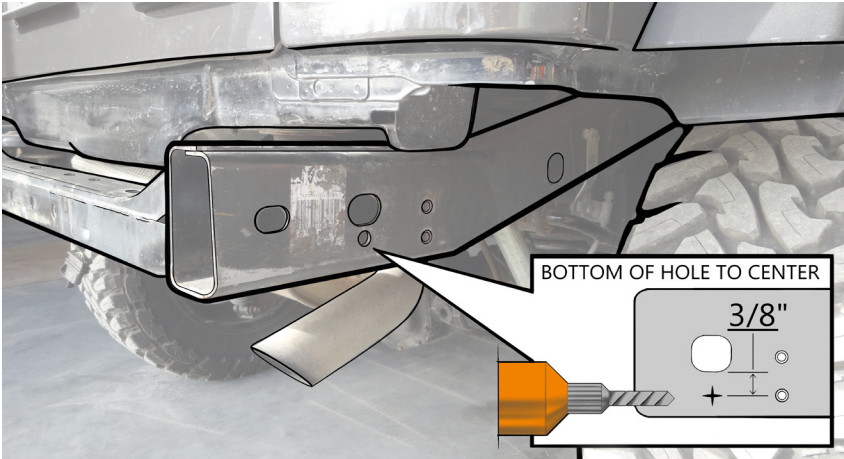

STEP 2 :

Each side of the frame will have a hole (shown here) that will need to be marked and drilled with a 1/2" drill bit.

This hole can be drilled with the bumper on the vehicle.



STEP 3 :

Install light bezels using (2) 1/4" Button Head screws.



STEP 4 :

Carefully pick up the bumper and slowly center it, then move towards the Jeep.

Take care to avoid damaging the body with the bumper corners.

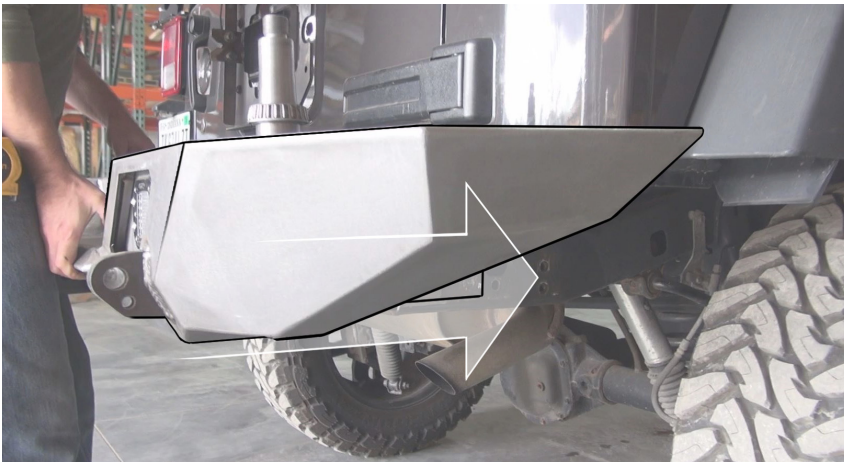

STEP 5 :

Slide the bumper forward onto the frame once the body of the bumper is aligned with the body of the vehicle.

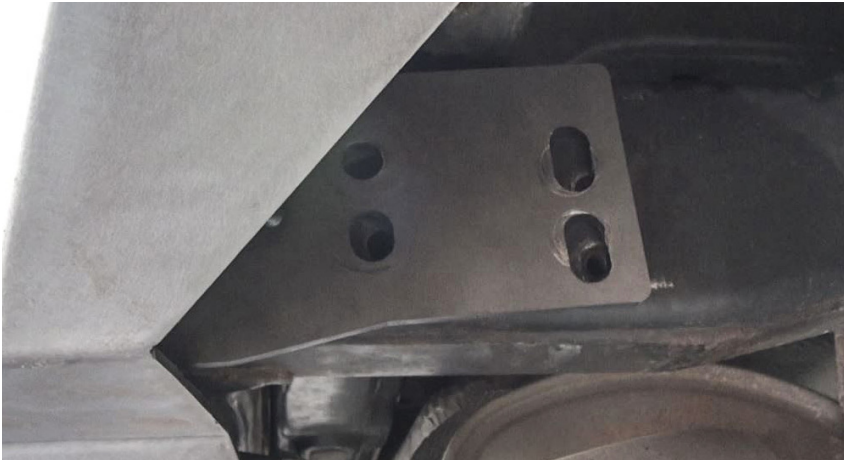

STEP 6 :

Do not let go of the bumper, as it may fall unsupported. While keeping pressure on the bumper, check that the two stock holes (circled) are lining up with the slotted holes in the bumper



STEP 7 :

Insert the two stock frame bolts, but do not tighten them all the way.



STEP 8 :

You may now let go of the bumper, the stock bolts will prevent it from falling off.



STEP 9 :

Insert the 4" long bolts into the opening (you may have to flip the bolt in the picture). The bottom hole should have been drilled by this point to provide a space for the bottom 4" bolt.



STEP 10 :

After inserting the bolts, attach the frame backing plate onto the studs, then attach the nuts and washers.

The washers will overlap (pictured on the right). This is fine, they will be squished down when the bolts are tightened. If you are so inclined, you can trim the washers so they do not overlap.



STEP 11 :

Attach the trailer plug to the provided safety chain plate.



STEP 12 :

Locate the two horizontal bolts and align with the holes on the safety chain plate. Face the bent corner towards the front of the vehicle.

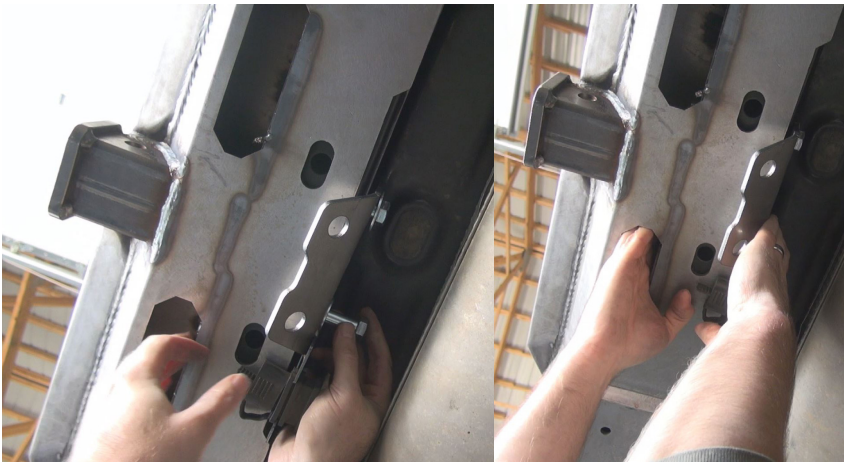

STEP 13 :

Insert the bolts, and loosely thread on the nuts and bolts using the access hole cutouts.



STEP 14 :

At this point, we will be leveling* the bumper.

Having a level bumper is crucial to the proper functioning of the carrier.



STEP 15 :

Measure the gap between the bumper and Jeep body on both sides, the measurements should be equal.



STEP 16 :

Tighten the stock bolts, one at a time on each side, one side at a time.



STEP 17 :

As you go back and forth tightening the bolts, keep checking your gap measurements to make sure the bumper has not shifted.



STEP 18 :

After tightening one bolt on the passenger/driver side, check your measurements then repeat in the corresponding bolt on the opposite side of the car.



STEP 19 :

Use a wrench to reach and keep the nuts in place while you tighten the bolts.



STEP 20 :

Using the access holes and the 3/4" wrenches, tighten the bolts that hold the safety chain plate to the crossmember.

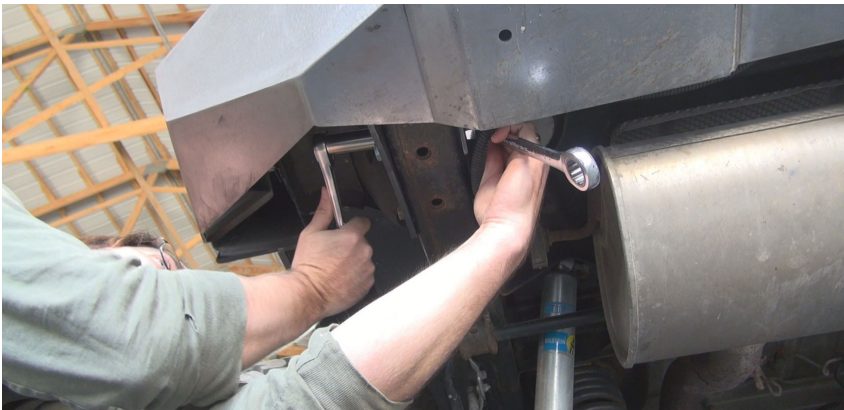

STEP 21 :

Check that all of the bolts securing the bumper to the Jeep are tight now.

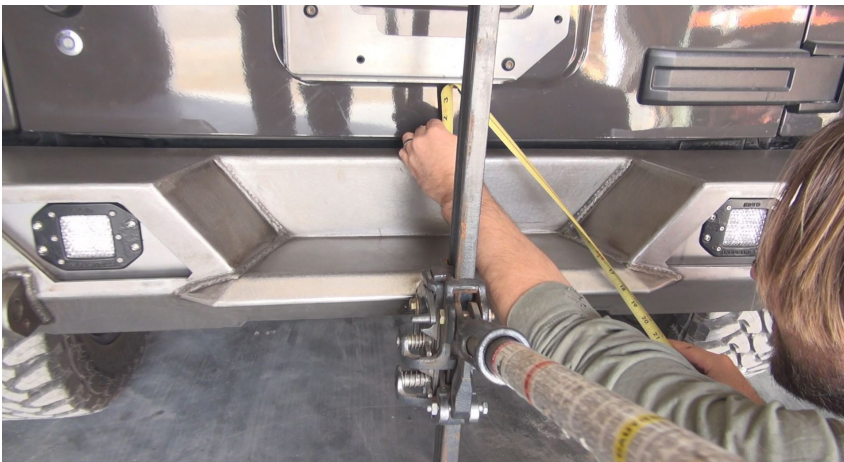

STEP 22 :

Measure the middle and corner gaps between the Jeep body and the bumper to make sure it has not changed.

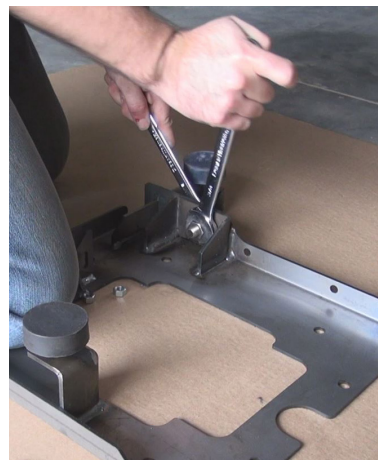

STEP 23 :

Install the ball stud included with the quick latch, you may apply Locktite to the threads.



Using a 5/8" wrench on top and a 3/4" wrench on the bottom, tighten it down.

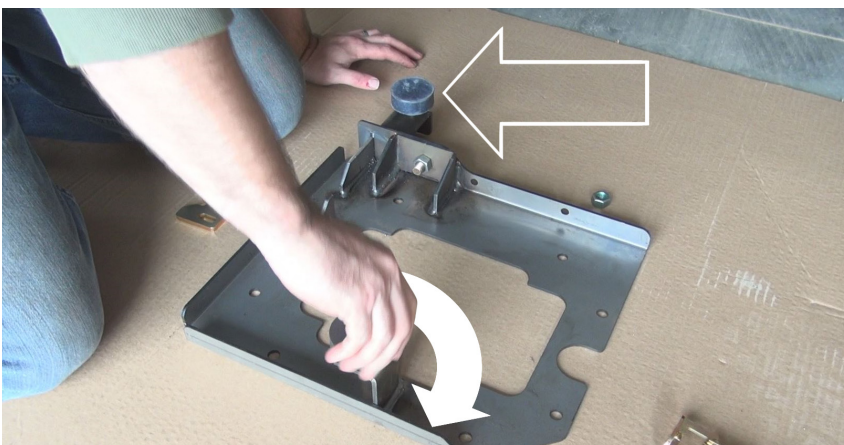

STEP 24 :

Twist in the two rubber bumpers that came in the installation kit.



STEP 25 :

Attach the striker plate/washer with the **TWO 5/16"** bolts provided in the install kit.

With this latch, final adjustment should be done with the carrier loaded

The striker plate is polymer, sandwiched with a metal "washer" plate to distribute force.



STEP 26 :

Attach the door plate to the stock bolt holes on the Jeep door with the 8 stock bolts.



STEP 27 :

At this point you should thoroughly pack **BOTH** of the wheel bearings with grease.

In our install video we provide a small instructional segment on how to do this.

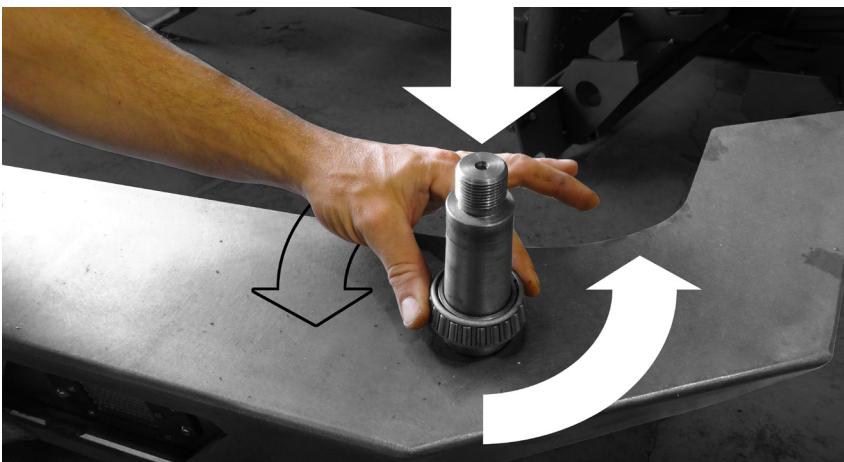

STEP 28 :

Place bearing LM29749 onto the spindle, tapered side up. It should slide down all the way and spin freely. If not, you are using the wrong bearing.

Make **SURE** to check the bearing number to make sure you have the correct one. Mixing up the bearings can damage the spindle.



STEP 29 :

Flip the carrier arm upside down, so the arm is horizontally on top. Take the bearing from Step 28 and place it, taper down, into the opening.

Next, place the bearing seal on top of the bearing. The text on the seal must face out.



STEP 30 :

Do NOT use a hammer directly on the seal or you WILL deform/damage it or the carrier. Tap it down

Use something soft like a block of wood to spread out the force as you lightly tap the seal into place, otherwise you will void your warranty.

STEP 31 :

Under no circumstances should you force the bearings onto the spindle. If you find the bearing doesn't fit, polish/sand the spindle very slightly. Be careful to not take off too much material.

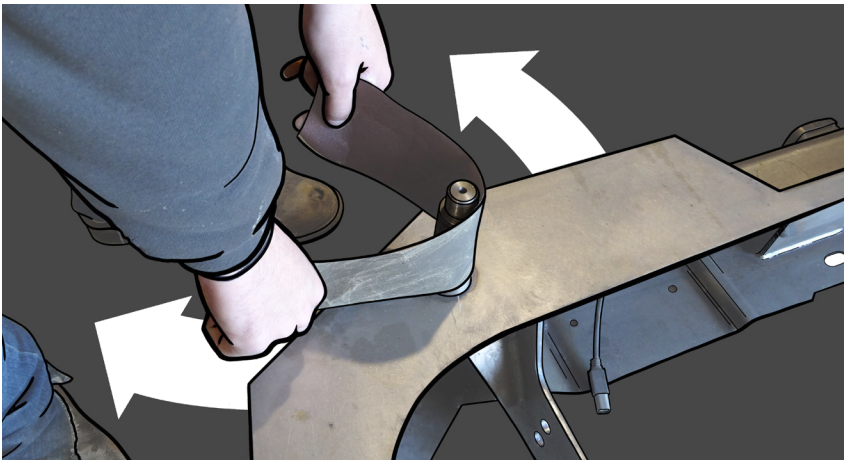

STEP 32 :

Place the carrier arm down onto the spindle. Make sure to keep the welded tube portion perpendicular to the spindle.





STEP 33 :

Place the top LM48548 bearing (greased in **step 27**) into the spindle, with the taper facing down.



STEP 34 :

Place a washer onto the spindle, then the 1" spindle nut on top. Be sure to add Locktite to the spindle threads before you tighten the nut completely.



STEP 35 :

Tighten down the nut with a 1-1/2" socket

Then add the top aluminum cap, and also tighten that with the 1-1/2" socket.



STEP 36 :

Test the swing arm operation by moving the door back and forth. The motion should be smooth and unobstructed.



STEP 37 :

Attach the latch alignment guide to the back of the carrier with the provided $\frac{5}{16}$ " hardware. Attach it loosely so that it can be shifted slightly.

If you plan on loading the carrier, (we used a tire) it will shift down slightly, so you may have to re-adjust it.

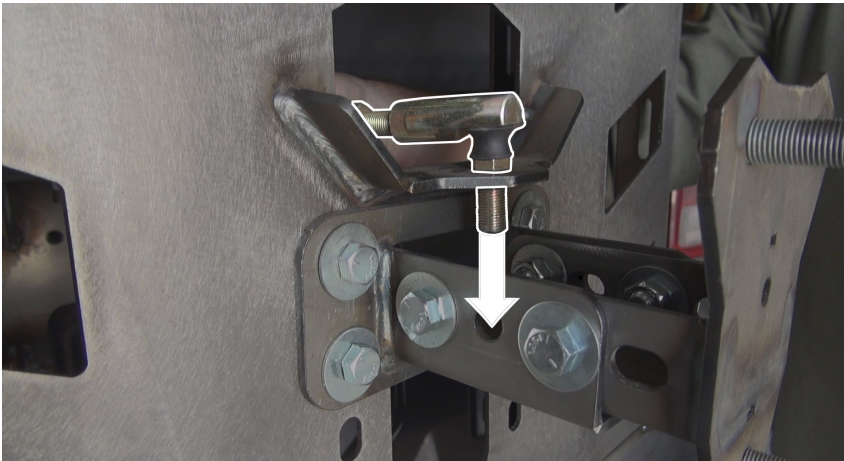

STEP 38 :

Install the quick latch by inserting the threaded parts through the mount holes and attaching with the washers and $\frac{1}{2}$ "-20 hex nuts on the other side.

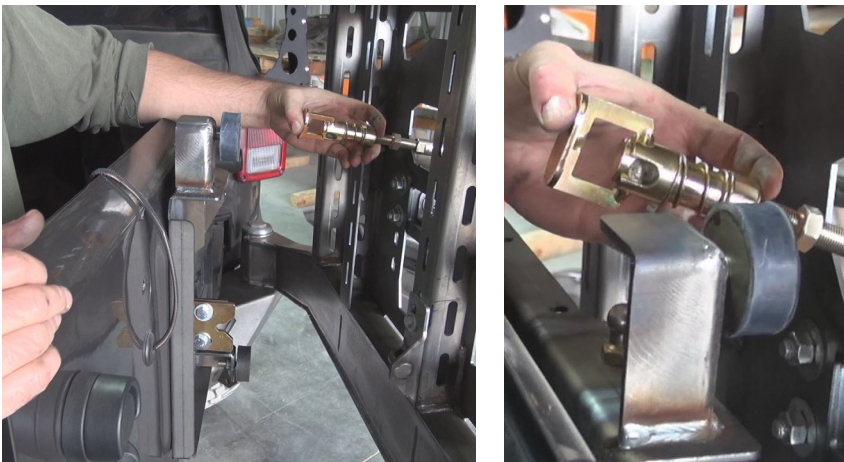

STEP 39 :

Standing behind the Jeep door, grab the quicklatch with your left hand and slowly move the door until it is close enough for the latch to be operated.

Press down on the plunger with your thumb and swing the latch down onto the mount stud to attach the latch to the mount stud on the door plate.

ANTI-RATTLE SYSTEM:

The three components of the system pictured here need to be adjusted in conjunction for the tire carrier to work properly.

They must be adjusted in the order listed for the correct fit and function.

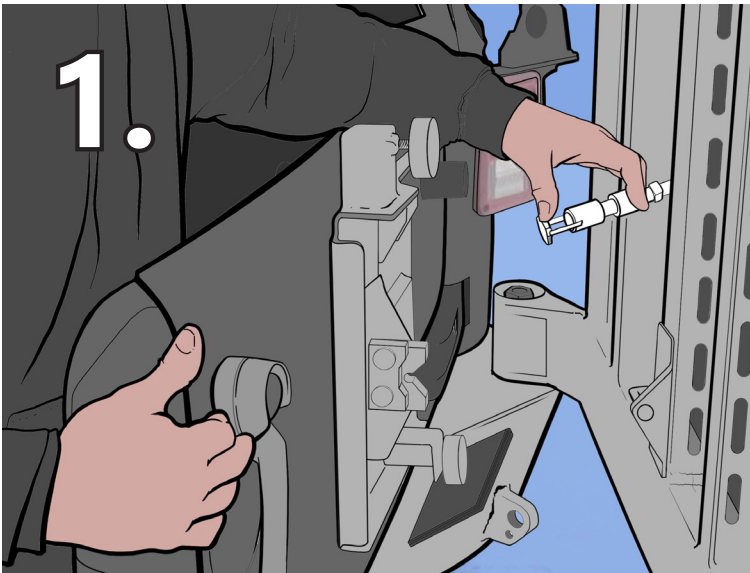

QUICKLATCH + JACKSCREW + BALL STUD

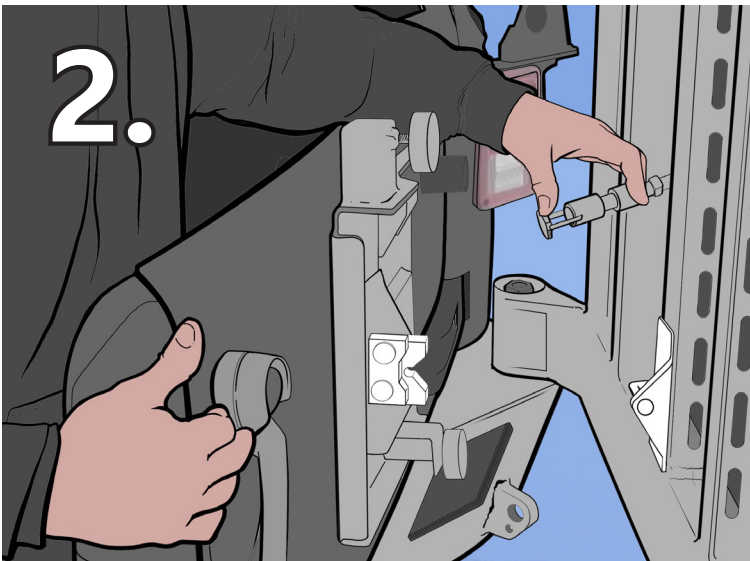

STRIKER PLATE + GUIDE ROD PLATE

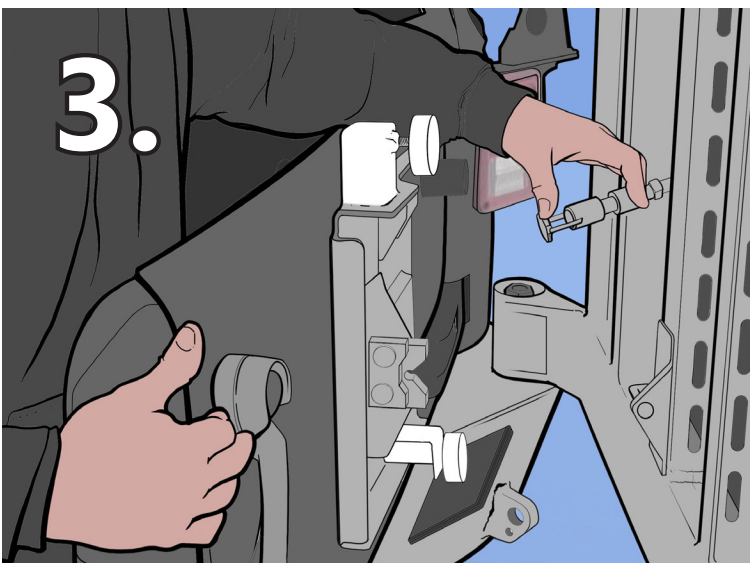

RUBBER ISOLATOR PUCKS



STEP 40:

With tailgate and carrier open, stand as illustrated and join the two using the quick release thumb latch.

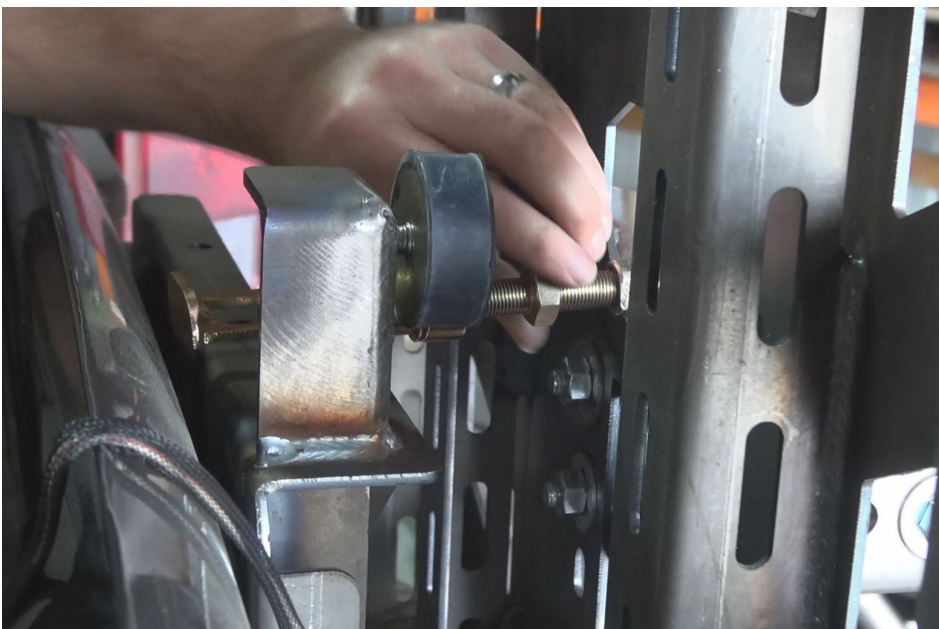

STEP 41:

The carrier and tailgate must be closed for this step.

Adjust the distance between the carrier arm and the Jeep tailgate by adjusting the jack screw latch system. This will make sure the carrier arm and bumper face are parallel (**shown in Step 42**)

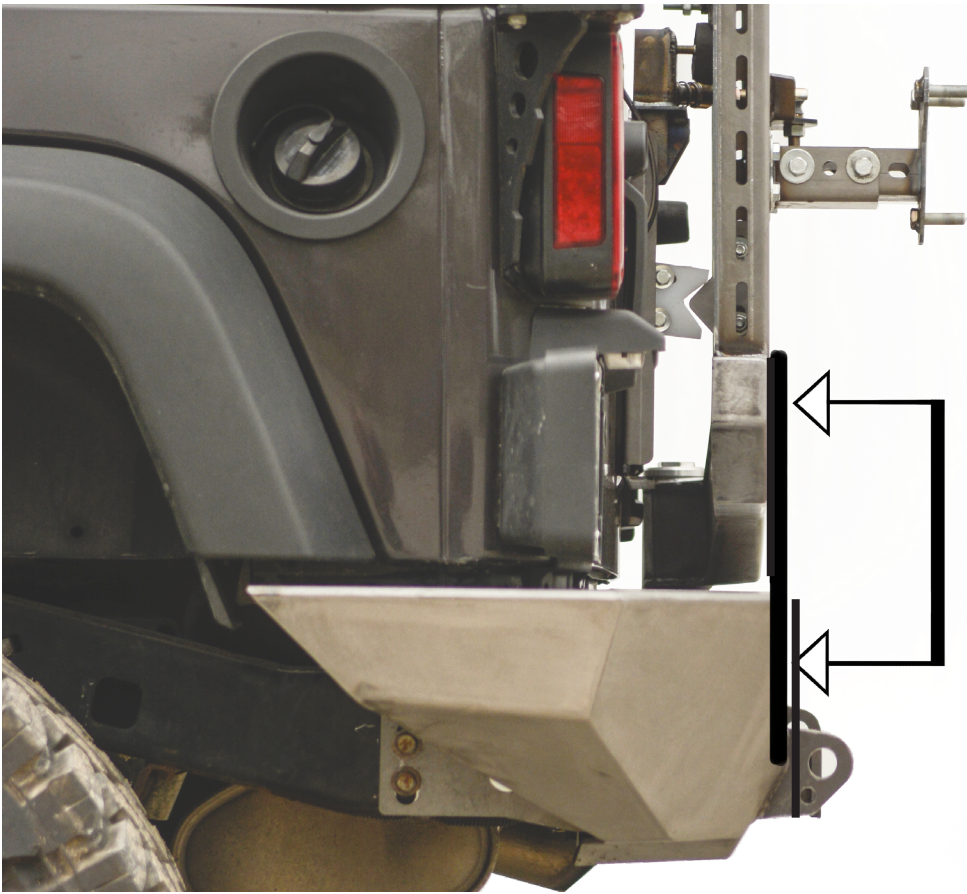

STEP 42 :

In order for the carrier to close and stay shut properly, the carrier arm face and bumper face must be oriented perpendicular to the side (profile) view.

Use the jack screw to adjust (illustrated in **Step 41**).

**** Do NOT try to line the faces up, they are not meant to be on the same plane, just parallel, meaning the carrier arm is not swung out nor in too far****

STEP 43 :

With the rear tailgate and carrier linked, open the tailgate so there is a 7 - 10" gap, now you are ready to adjust the striker plate/guide rod.

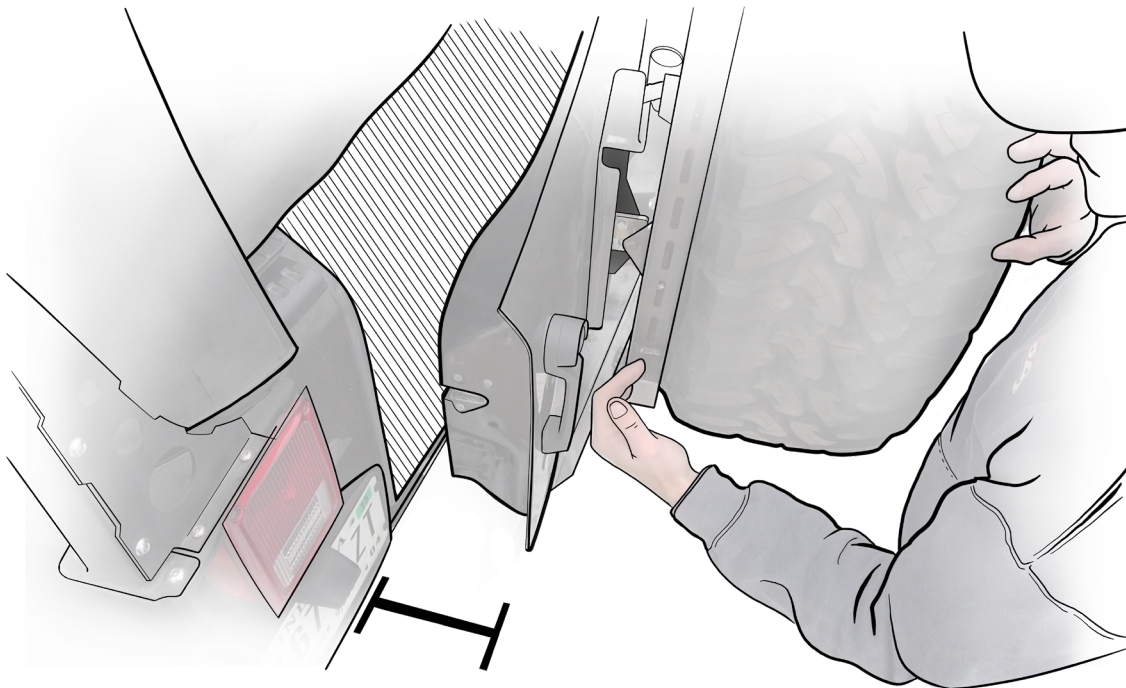

7"-10" GAP



STEP 44 :

With the tailgate still open **7 - 10"** adjust the striker latch and guide rod so they touch, as shown here.



STEP 45 :

Now carefully close the door, taking care to not slam it shut. It should shut and latch smoothly, engaging fully and slightly wedging into the slot.

Pressure on the rod is REQUIRED when engaged into the slot in the closed position.

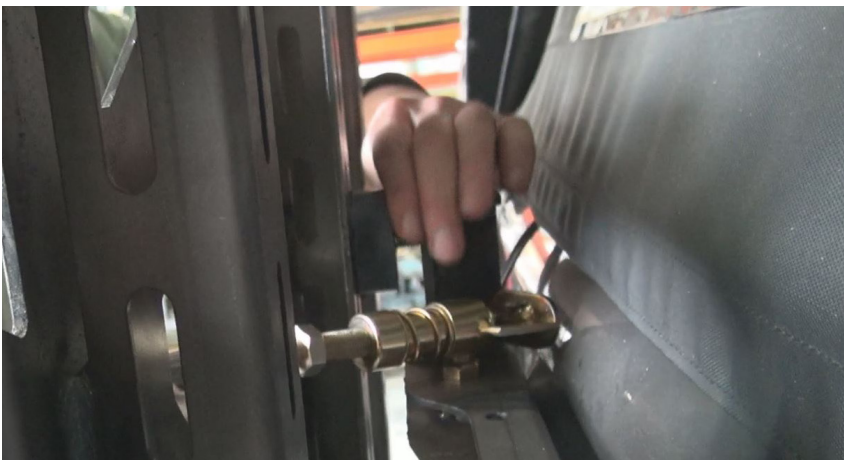

STEP 46 :

After the quicklatch and striker plate are adjusted, open your carrier 7 - 10 inches again, and unscrew the rubber pucks so they touch the back face of the carrier.

when closed the isolator pucks must be squished, as seen below



STEP 47 :

The pucks must squish slightly when the carrier is shut, with enough pressure to keep a loaded carrier from rattling.

When closed they (the pucks) should look like this.

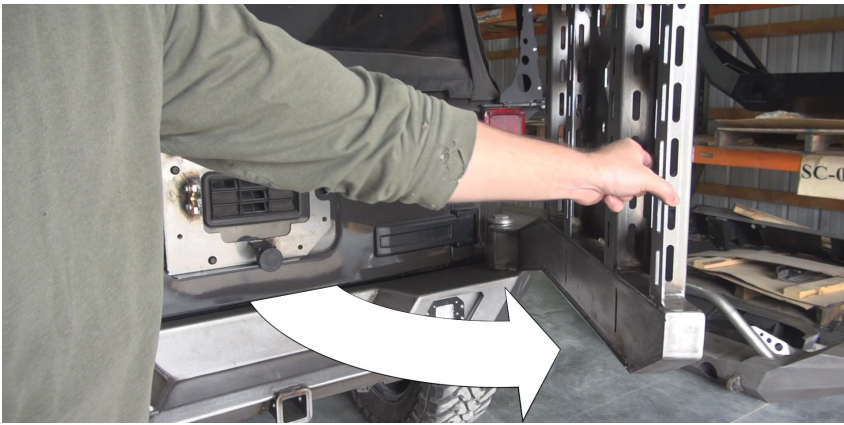

STEP 48 :

Test the door, making sure it does not rattle when closed. If it does, repeat steps **42 - 48**.



STEP 49 :

Now attach both of the tire mounts to the carrier body. Use an $1\frac{1}{16}$ " wrench on the nuts and $\frac{5}{8}$ " wrench on the bolts.

After this step, you should be ready to attach a spare tire or equipment.



STEP 50 :

The spare tire mount is designed to "pull" the tire tight against the carrier using the lug studs.

There can be a gap between the wheel and mount when mounted. Simply adjust the mount in or out until the tire rubber touches the carrier before the rear face of the wheel touches the plate with the lug studs.



Your tire should squeeze against the back plane of the tire carrier at the top and the bottom.

There could be a small gap between the back face of the wheel and the Tire Mount Bracket depending on your wheel back spacing. Do not over-tighten the lug nuts because this will cause excessive stress on the Tire Mount Bracket.

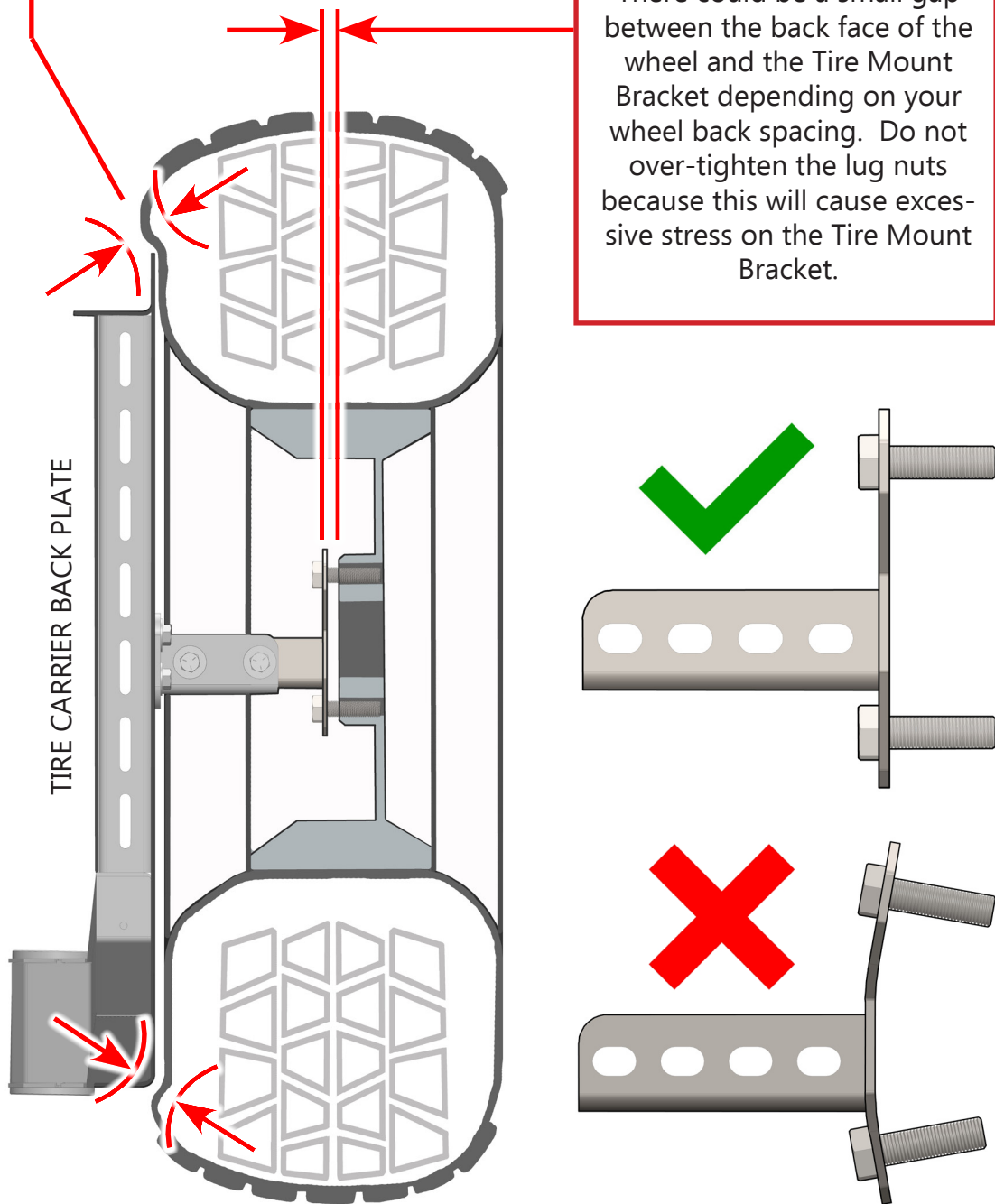

WARNING!

To prevent excessive tire shaking, your tire must be squeezed and making contact with the Tire Carrier Back Plate. Failure to do so could lead to Tire Bracket failure and the loss of your tire.

POST-INSTALL : Troubleshooting

If you encounter any trouble or rattling, please review the following information, as it may be helpful in understanding the proper function and setup of the tire carrier combo.

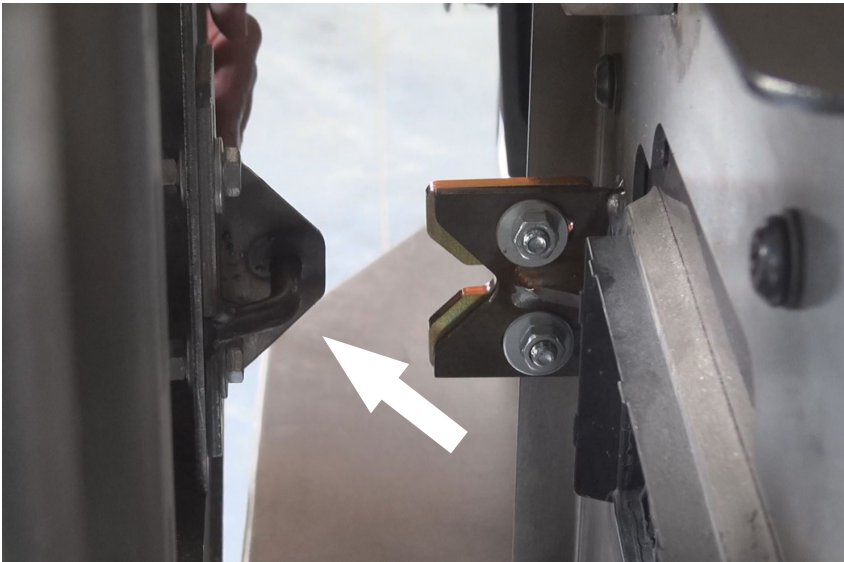

STEP 51 :

If you plan on loading the carrier with weight, (we used a 35" tire) plate A will shift down slightly, causing it to catch on B*. To stop any interference, you will have to **re-adjust B** to be **centered with A** again **after the carrier is loaded with its full weight** you plan to carry.

reference diagram in troubleshooting section at end

STEP 52 :

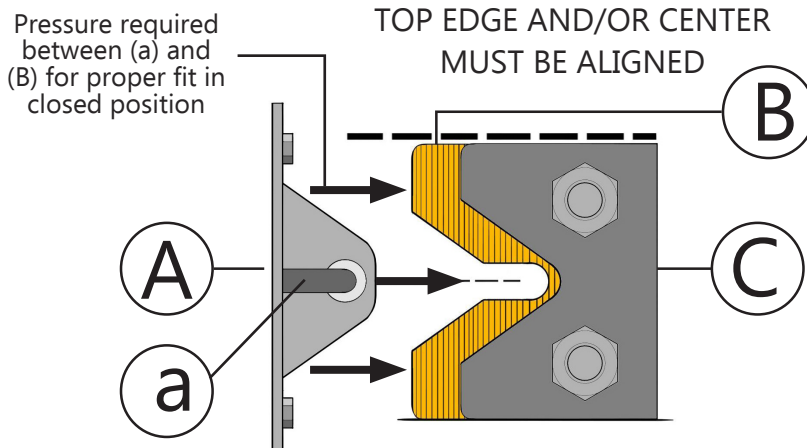

Here is a closer look at the striker mechanism. The alignment plate rod (a) should be centered to the cutout in (B). The top edges of (B) and (C) should line up.

Offset (B) towards (A) slightly and tighten it down. This way there will be a slight pressure on B and it will prevent A from rattling (shown with black arrows)

STEP 53 :

When the door is closed, the alignment plate should fit together smoothly. If it does not, adjust the height of (B)* slightly.

*references **Step 52**

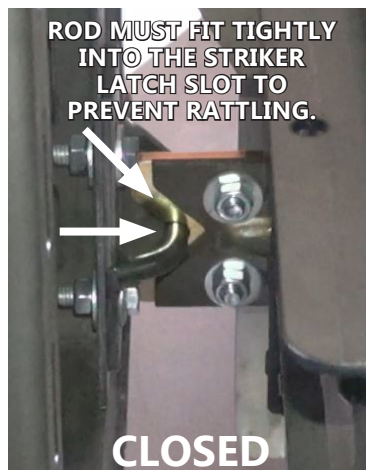



STEP 54 :

This diagram illustrates final bumper fitment with the carrier shut. The top of the bumper is level to the body of the Jeep. The carrier is tilted slightly towards the vehicle.

TIP 1 : If you find that the carrier does not shut properly, MAKE SURE you check the level of the bumper to the vehicle body lines, as it may have shifted during installation.

TIP 2 : If you find that the rubber bumpers are not long enough, again, check your mounting bolts, level of the bumper, striker plate, and jack screw distance.

Attach The Swing Stop to prevent body damage

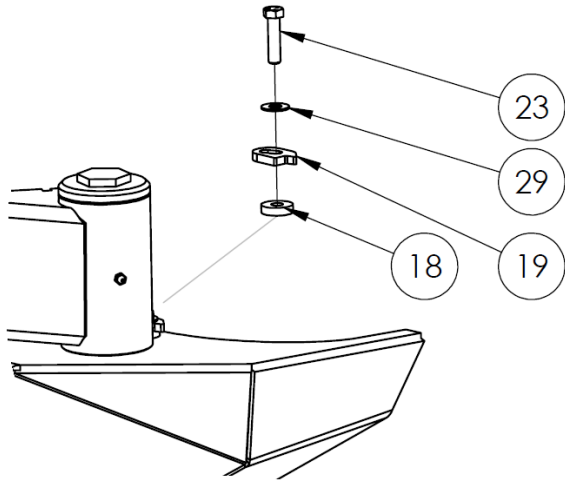

Install the Swing Stop using the 3/8" bolt and washer on top and the 1/4" spacer underneath.

Specifications:

Max Tire size:

40" without accessory mounts
38" with accessory mounts

Weight Limits:

300 lbs Max combined weight
(includes tire, accessories and accessory mounts)

Only install one accessory per side. Do not double stack accessories

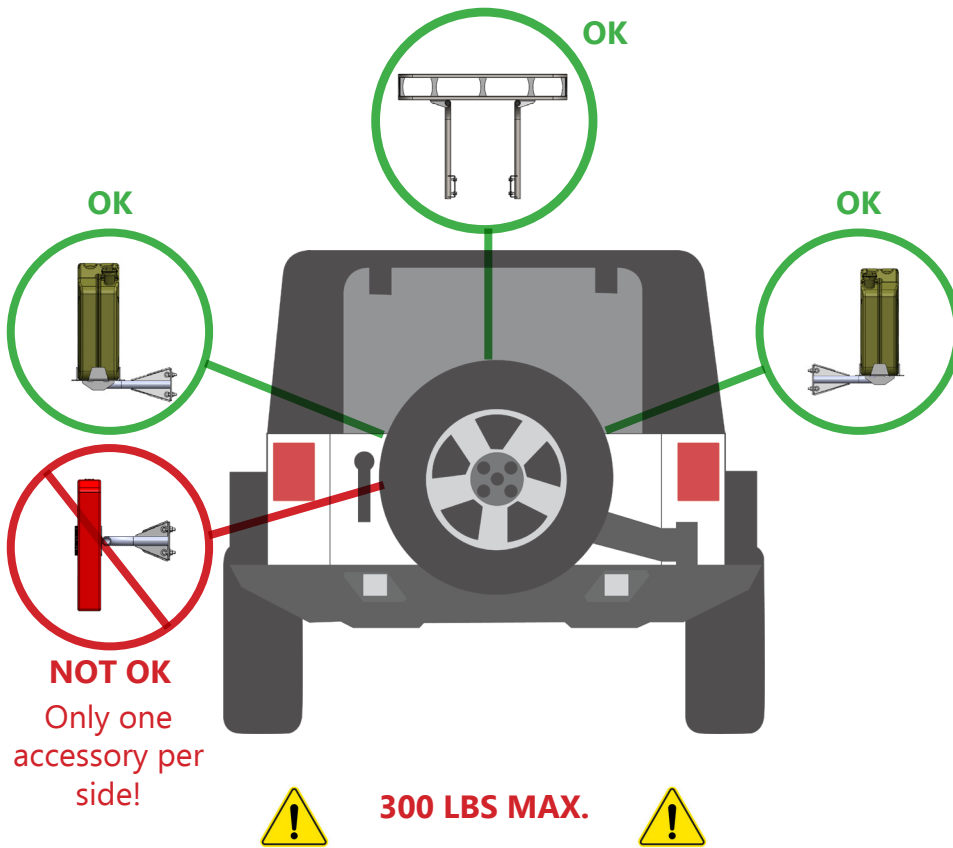

Maintenance

Tire Carrier & Swing Arm:

- Once per year or as needed, add bearing grease to the Tire Carrier Swing Arm Spindle via the grease fitting on the side of the spindle. We suggest using a Lithium type automotive multi-purpose grease or wheel bearing grease (Red) that is water resistant.
- Periodically check and re-tighten all fasteners. Adjust the swing arm isolators and latch to ensure rattle free operation.
- Periodically check your Bumper and Tire Carrier and accessory mounts for scratches, dings, or rust spots which can happen over time or after heavy use. It is important to address these areas as soon as possible to prevent rust and corrosion from spreading. We recommend using Rustoleum® brand Black Semi-Gloss Protective Enamel (oil based). Apply using a foam brush by dabbing to match the powder coat texture.



ITEM NO.	PART NUMBER	DESCRIPTION	QTY.
1	4J1C1001-12	DESTROYER SHORTY REAR BUMPER WITH CARRIER WELDMENT	1
2	4J1C1001-02	JEEP JK TIRE CARRIER DOOR PLATE WELDMENT	1
3	2J1C1002-03	SPINDLE CAP	1
4	LOD logo	Logo Plate	1

HARDWARE KIT			
ITEM NO.	PART NUMBER	DESCRIPTION	QTY.
5	4J1C1001-04	TIRE MOUNT BRACKET	1
6	4J1C1001-03	TIRE MOUNT	1
7	450068	TIMKEN BEARING SEAL 450068	1
8	4J1C1001-09	QUICK RELEASE LATCH	1
9	2J1C1001-43	POLYMER STRIKER PLATE	1
10	2J1C1001-55	STRIKER BACKUP PLATE	1
11	4J1C1001-07	STRIKER CATCH	1
12	4J1C1001-10	SAFETY CHAIN PLATE	1
13	2J1C1001-52	RUBBER ISOLATOR	2
14	2J1C1001-51	FRAME BACKUP PLATE	2
15	JM48548	TOP-TAPERED BEARING	1
16	JM29749	BOTTOM-TAPERED BEARING	1
17	2J1C1001-22	BEARING WASHER	1
18	2J1C1800-11	SWING STOP SPACER	1
19	2J1C1800-10	SWING STOP	1

BOLT KIT			
ITEM NO.	PART NUMBER	DESCRIPTION	QTY.
20	BHSCS25008SS	BHSCS 1/4-20 X 0.50 STAINLESS STEEL	4
21	FW5022ZF	FLAT WASHER Ø1/2" X 1.375" ZINC PLATE	16
22	HN50132PGR5	HEX NUT 1/2-13 ZINC PLATE GR5	8
23	HB381624PGR5	HEX BOLT 3/8-16 X 1.500 ZINC PLATE GR5	1
24	HB501364PGR5	HEX BOLT 1/2-13 X 4.000 HEX BOLT ZINC PLATE GR5	6
25	HB431416PGR5	HEX BOLT 7/16-14 X 1.000 HEX BOLT ZINC PLATE GR5	8
26	HB311816PGR5	HEX BOLT 5/16-18 X 1.000 ZINC PLATE GR5	2
27	HB311824PGR5	HEX BOLT 5/16-18 X 1.500 ZINC PLATE GR5	2
28	HB501372PGR5	HEX BOLT 1/2-13 X 4.500 HEX BOLT ZINC PLATE GR5	2
29	FW38162P	FLAT WASHER Ø3/8" X 1.000 ZINC PLATE	16
30	FW43162P	FLAT WASHER Ø7/16 X 1.257" ZINC PLATED	16
31	FW31142P	FLAT WASHER Ø5/16" X .875" ZINC PLATE	8
32	HN43142PGR5	HEX NUT 7/16-14 ZINC PLATE GR5	8
33	HN31182PGR5	HEX NUT 5/16-18 ZINC PLATE GR5	4
34	HN10142PGR5	HEX NUT 1-14 ZINC PLATE GR5	1
35	2J1C0701-10	GREASE FITTING 1/4-28	1
36	HP1002	HOLE PLUG Ø1/4 ID	3

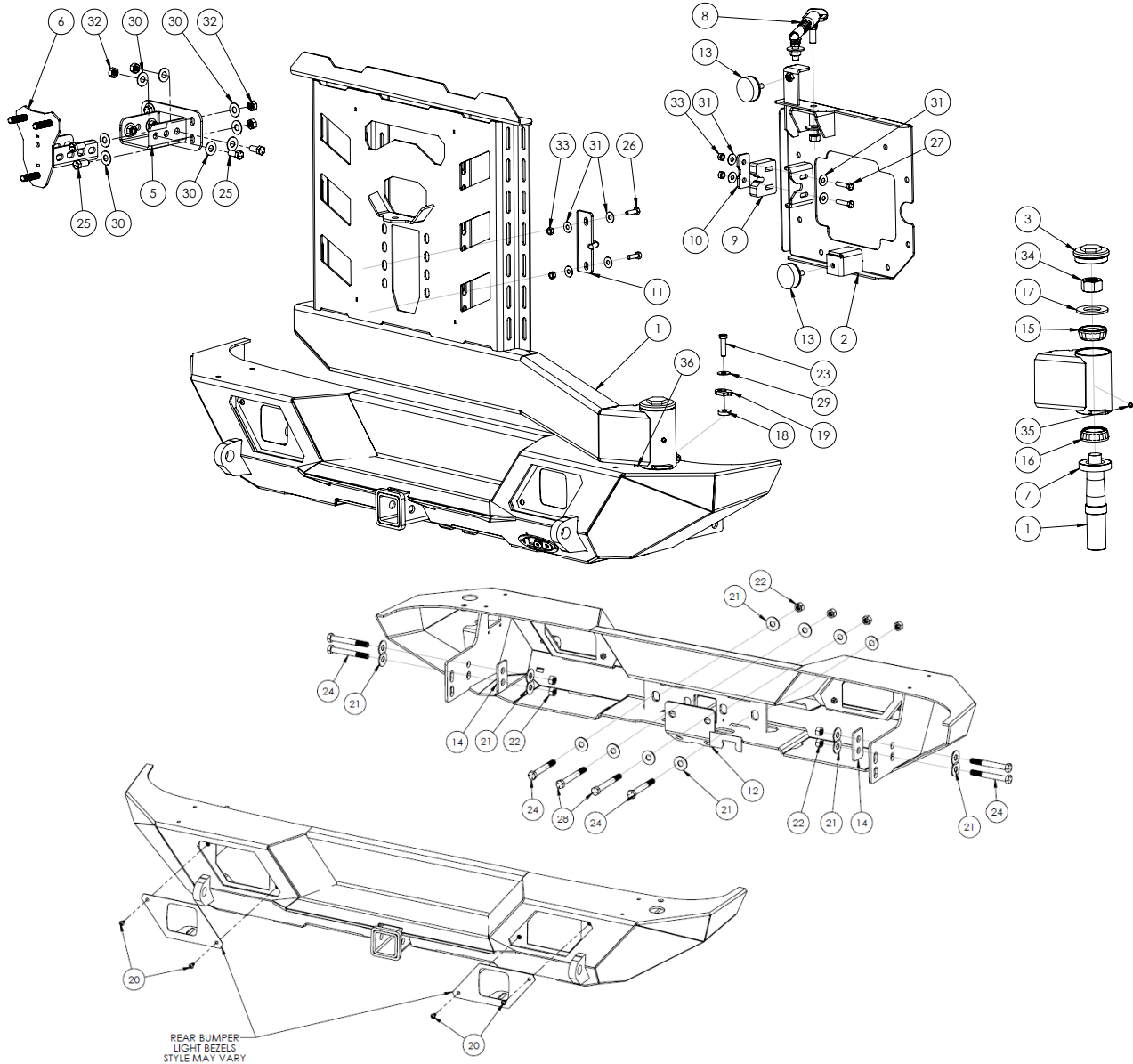
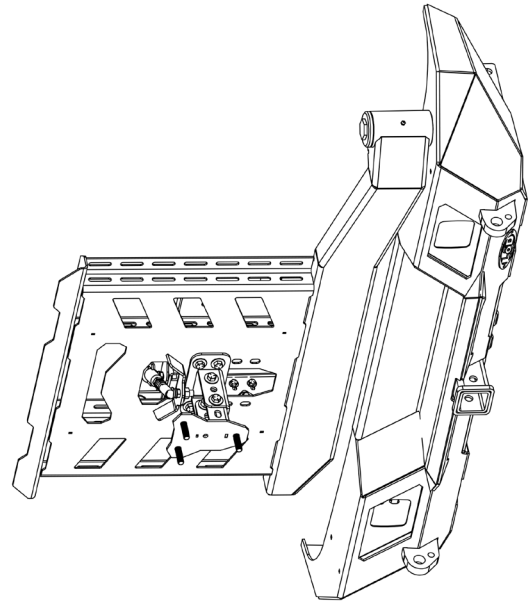



**JK Jeep
DESTROYER SERIES**

Tire Carrier

SHIPPING SHEET - 1

Packaged by:

On:

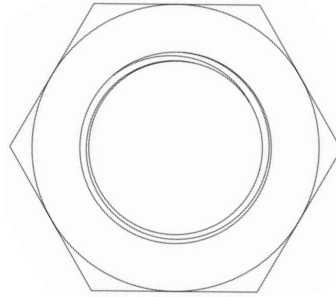

HEX NUT 1-14

(36370)

(x1)



installed on tire carrier spindle

Destroyer Rear Bumper
Tire Carrier Weldment

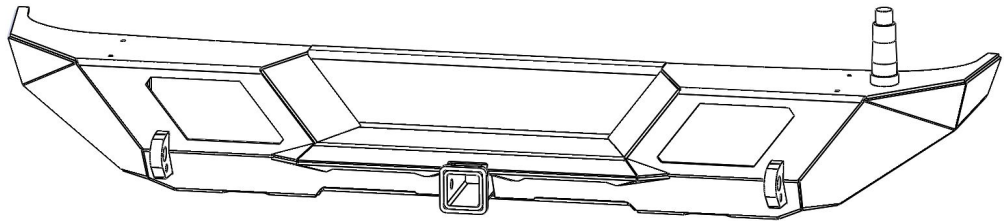

Hardware Kit
(contents
may vary)



JK TIRE CARRIER
DOOR PLATE
4JTC1001-02

(x1)

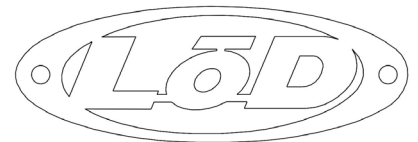
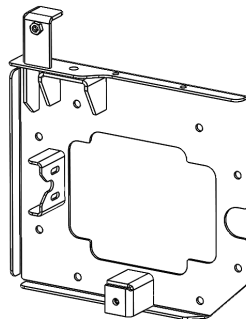

LOD LOGO
(packaged separate if
bumper is bare steel)



(x1)

Destroyer Light Bezels
(STYLE MAY VARY, ONLY ONE SET INCLUDED)



Blank / No light
JLB1851

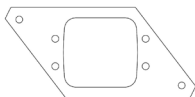

Universal
Flush Mount
Cube
JLB1821



Rigid Pro-Series
Dually
JLB1841

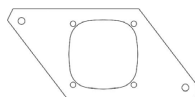

Baja Designs
Squadron
Flush Mount
JLB1863



Baja Designs
Squadron
JLB1865



Baja Designs
Squadron
Round
JLB1867



LoD Radiant
Pro LED Surface
Mount
JLB1869





JK Jeep
DESTROYER SERIES
Tire Carrier
SHIPPING SHEET - 2
Packaged by:

On:

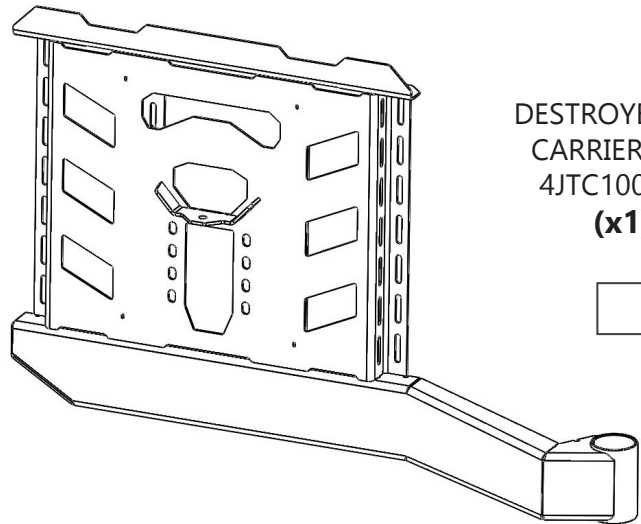

DESTROYER TIRE
CARRIER ARM
4JTC1001-01
(x1)

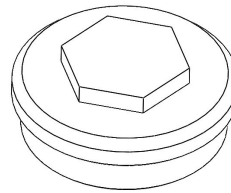

SPINDLE CAP
2JC1002-03
(x1)



*Installed in Tire Carrier Swing Arm

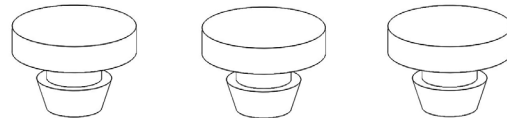

RUBBER HOLE
PLUG
HP1002
(x3)



*Installed in Tire Carrier Swing Arm



**JK Jeep
DESTROYER SERIES**

Tire Carrier
Hardware Kit Sheet - 1

Packaged by:

On:

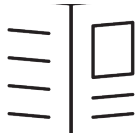

Instruction
Booklet

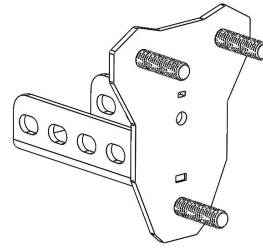

TIRE MOUNT
4JTC1001-03
(x1)

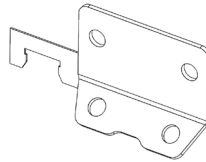

SAFETY CHAIN PLATE
4JTC1001-10
(x1)

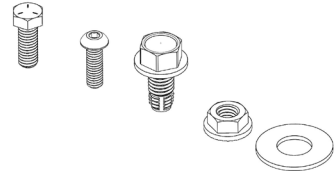

BOLT KIT
(may vary)

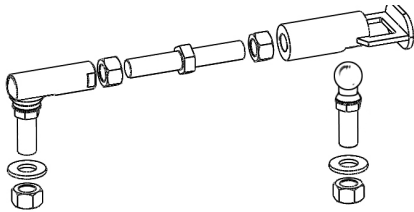

QUICK RELEASE LATCH
4JTC1001-09
(x1)

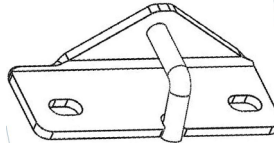

STRIKER CATCH
4JTC1001-07
(x1)

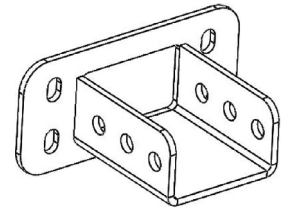

TIRE MOUNT BRACKET
4JTC1001-04
(x1)

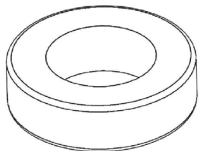

BEARING SEAL
450068
(x1)

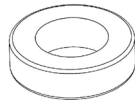

Top
Tapered
Bearing (LM48548)



Bottom
Tapered
Bearing (LM29749)

BEARINGS

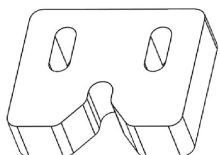

POLYMER STRIKER
PLATE
2JTC1001-43
(x1)

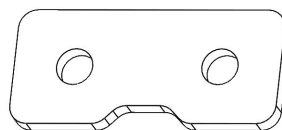

STRIKER BACKUP
PLATE
2JTC1001-55
(x1)





**JK Jeep
DESTROYER SERIES**

Tire Carrier
Hardware Kit Sheet - 2
Packaged by:

On:

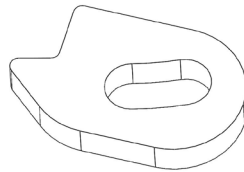

SWING STOP
2JBC1800-10
(x1)

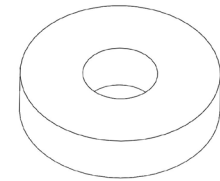

SWING STOP SPACER
2JBC1800-11
(x1)

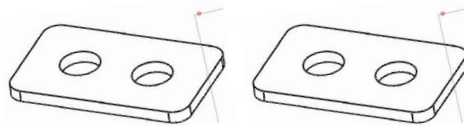

FRAME BACKING PLATE
2JTC1001-51
(x2)

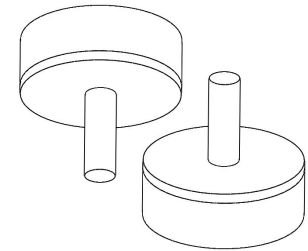

RUBBER ISOLATOR
2JTC1001-52
(x2)

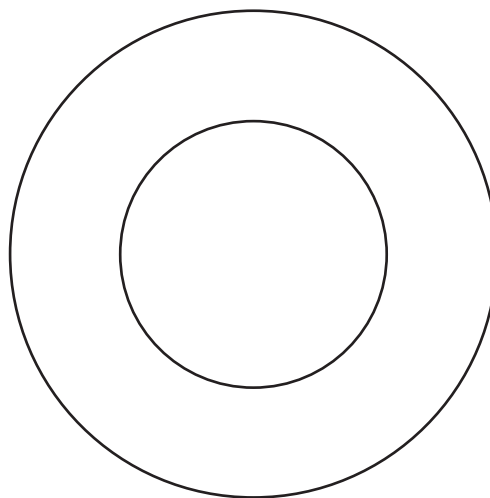

BEARING WASHER
1.395" X 2.542"
(x1)





**JK Jeep
DESTROYER SERIES**

Tire Carrier
Bolt Kit

Packaged by:

On:



GREASE FITTING
1/4-28
(58771)
(x1)



HEX BOLT 3/8-16 X 1.50"
(0137516)
(x1)

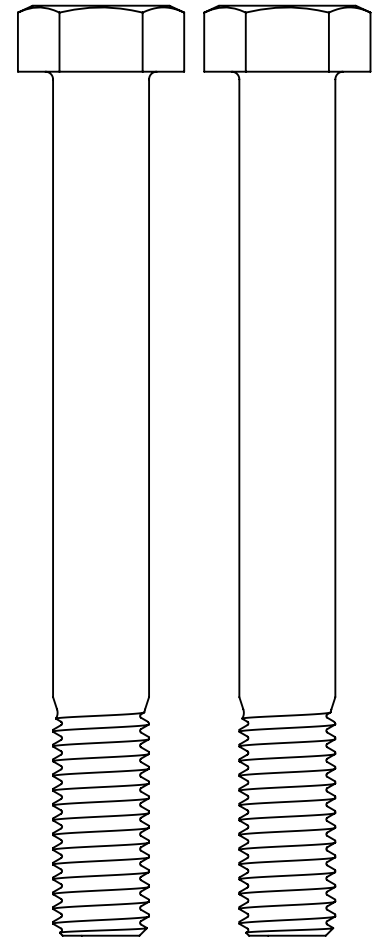
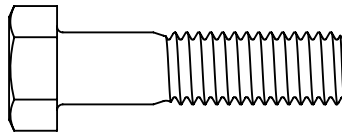

HEX BOLT 1/2-13 X 4.50"
(0137555)
(x2)



HEX NUT 5/16-18
(36304)
(x4)

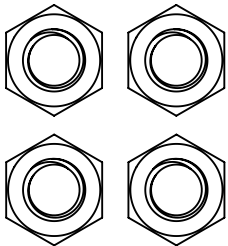

FLAT WASHER
Ø3/8" X 1.00"
(0159679)
(x1)

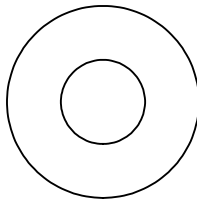

HEX BOLT 5/16-18 X 1.50"
(0137500)
(x2)

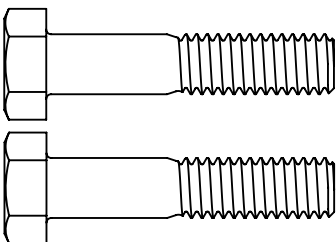

HEX BOLT 5/16-18 X 1.00"
(11105714)
(x2)

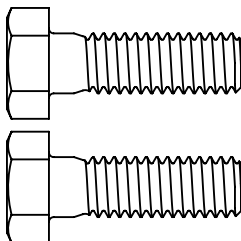

BUTTON HEAD
SCREW 1/4-20 X .50"
(94049)
(x4)

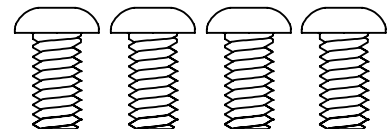

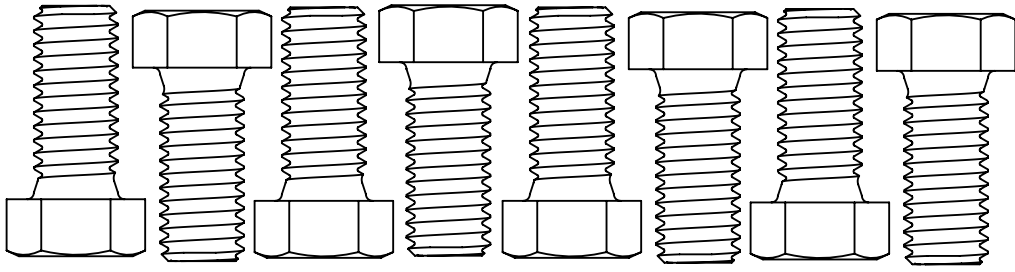

HEX BOLT 7/16-14 X 1.00"
(11105772)

(x8)

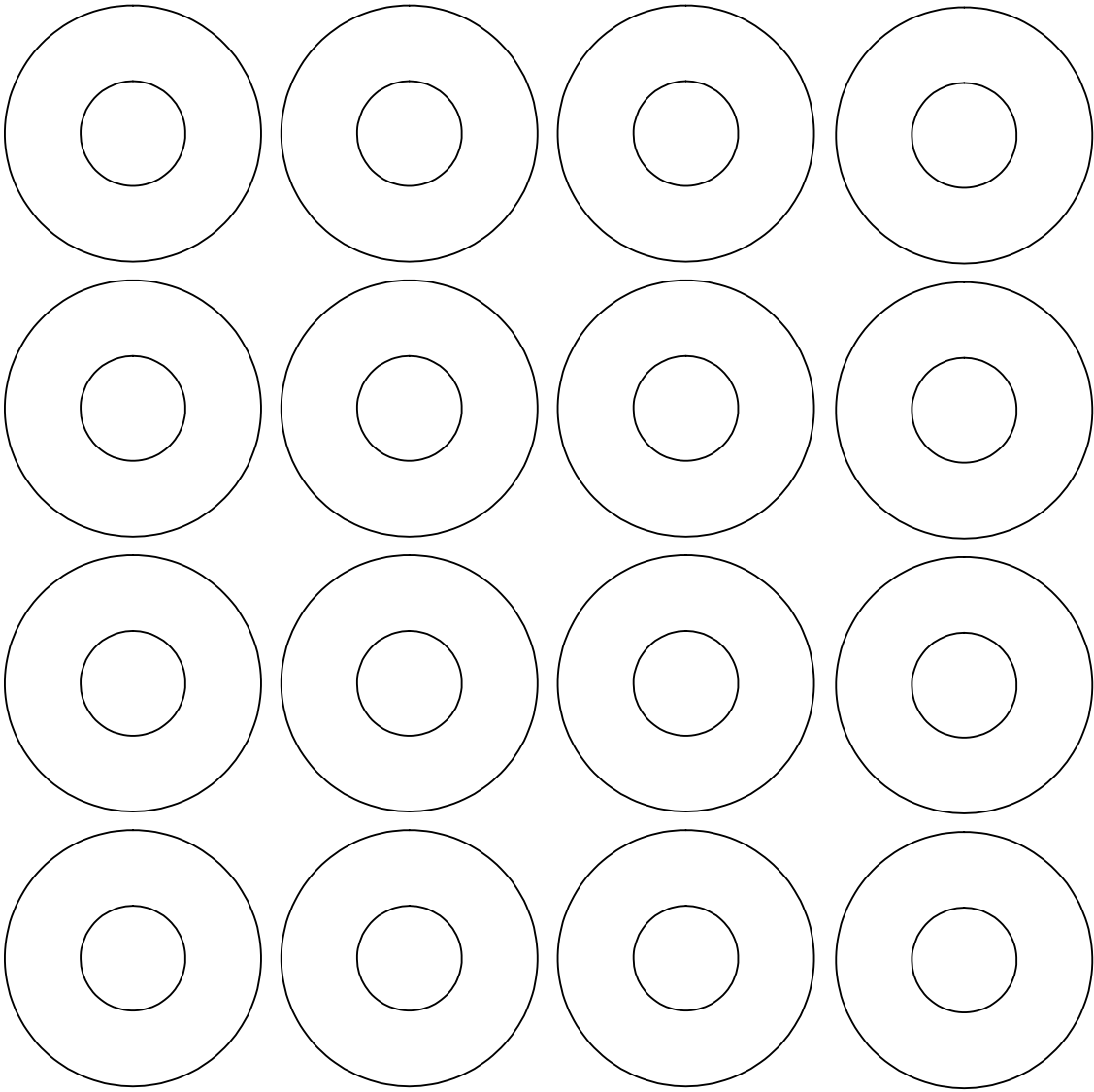

FLAT WASHER
Ø1/2" X 1.375"
(0159681)

(x16)



