

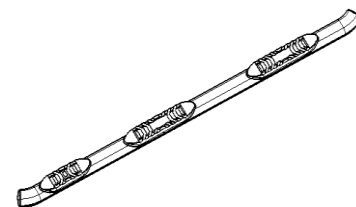

5" Oval W2W Nerf Bar

Part No. A7047S/B



Fits: 1999 - 2016

Ford F250/350 Super Duty Supercrew Cab With 8ft Long Bed



REMOVE CONTENTS FROM BOX. VERIFY ALL PARTS ARE PRESENT.



READ INSTRUCTIONS CAREFULLY BEFORE STARTING INSTALLATION.

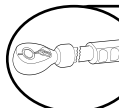

DO NOT OVER TORQUE. STANDARD OPERATING LOAD FOR TIGHTEN BODY MOUNT NUTS & BOLTS VARIES FROM 45 TO 65 FOOT POUND.



60-180 min

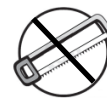

Cutting Not Required



Drilling Not Required



support@trailfx.com



1 866 638 4870



POLISHED STAINLESS STEEL – LIMITED LIFETIME
POWDER COATED BLACK – 3 YEARS

PARTS LIST:

| Qty | Part Description | Qty | Part Description |
|-----|--|-----|--|
| 1 | Driver/Left Wheel to Wheel Sidebar | 2 | 12mm Bolt/10mm Nut Plates Rear Bracket |
| 1 | Passenger/Right Wheel to Wheel Sidebar | 2 | 12-1.75mm x 35mm Hex Bolts |
| 3 | Driver/Left Cab Mounting Brackets | 4 | 12mm x 37mm x 3mm Flat Washers |
| 3 | Passenger/Right Cab Mounting Brackets | 3 | 12mm Lock Washers |
| 2 | Front Bracket Spacers | 3 | 12mm Hex Nuts |
| 1 | Driver/Left Bed Rear Mounting Bracket | 10 | 10-1.5mm Clip Nuts |
| 1 | Passenger/Right Bed Rear Mounting Bracket | 30 | 10-1.50mm x 30mm Hex Bolts |
| 1 | Driver/Left Rear Tube Bracket | 48 | 10mm x 27mm x 3mm Flat Washers |
| 1 | Passenger/Right Rear Tube Bracket | 30 | 10mm Lock Washers |
| 1 | Driver/Left 2011-015 Rear Support Bracket | 18 | 10mm Hex Nuts |
| 1 | Driver/Left 1999-010 Rear Support Bracket | 16 | 8-1.25mm x 25mm Hex Bolts |
| 1 | Passenger/Right 1999-015 Rear Support Bracket | 16 | 8mm x 22mm OD x 2mm Flat Washers |
| 1 | 12mm Bolt Plate 2011-015 Driver Side Rear Bracket Use Only | 16 | 8mm Lock Washers |

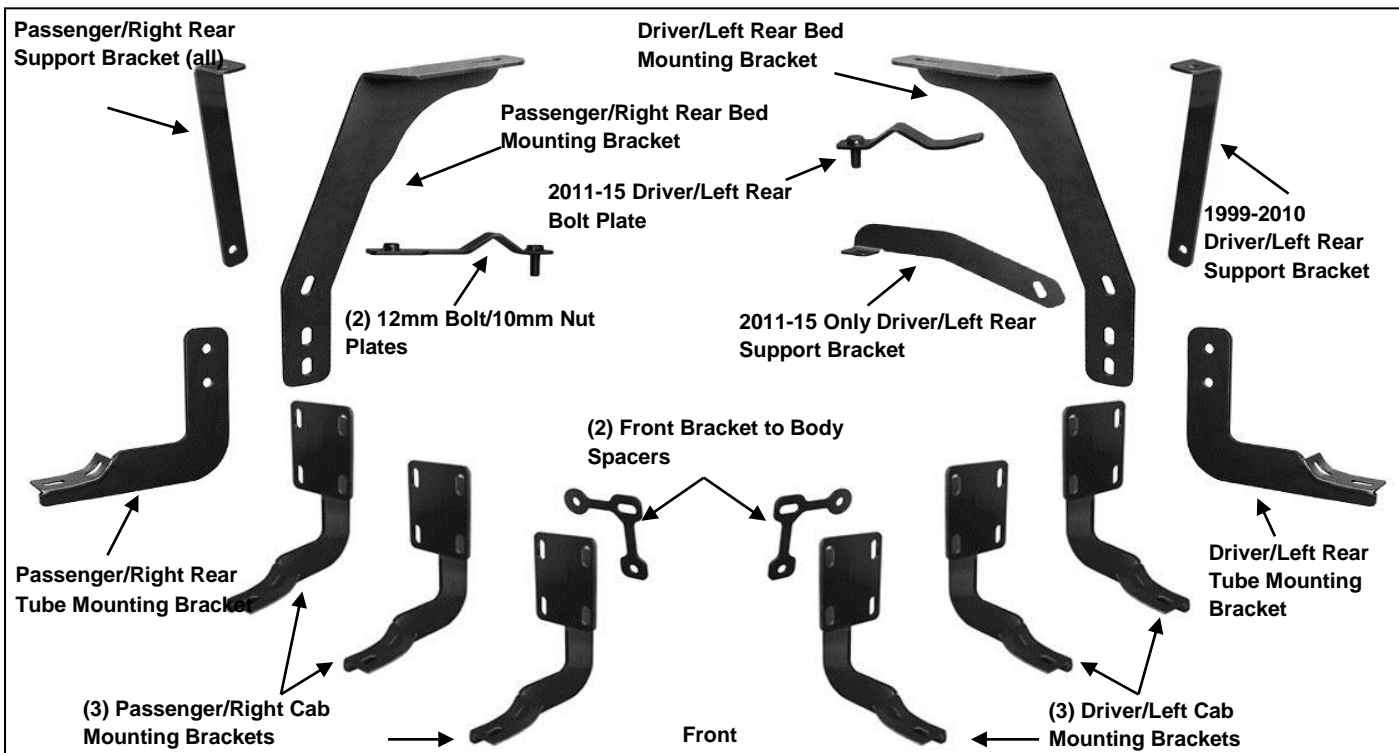

INSTALLATION PROCEDURE:

1. Starting on the driver side of the vehicle, locate the (5) pairs of factory holes in the pinch weld under the rocker panel, **(Figures 1A, 1B, 2 & 6)**. The mounting locations for the (3) Brackets attached to the cab will be the 1st, 3rd and 5th pairs of mounting holes, **(Figure 1A)**. An additional 4th Bracket will also attach to the channel on the bottom of the bed. **NOTE:** Mounting locations may be covered with tape or undercoating. Remove tape and/or undercoating as necessary to ensure that Brackets are attached directly to the body panels.
2. Move to the driver side front mounting location, **(Figure 1B)**. Select (1) 10mm Clip Nut. Insert the Clip Nut into the rectangular opening first then slide the Nut over the round hole next to the opening, **(Figure 2)**. **NOTE:** Threaded Nut must go towards the inside of the body panel.
3. Next, select (1) Front Bracket Spacer and (1) Driver Side Bracket. Line up the (2) end holes in the Spacer with the Clip Nut and the forward hole in the pinch weld, **(Figure 3)**. Insert (1) 10mm Hex Bolt, (1) 10mm Lock Washer and (1) 10mm Flat Washer through the top hole in the Bracket, the Spacer and into the Clip Nut, **(Figure 4)**. Leave hardware loose. Bolt the bottom of the Bracket to the pinch weld, (and Spacer), with (2) 10mm Hex Bolts, (4) 10mm Flat Washers, (2) 10mm Lock Washers and (2) 10mm Hex Nuts, **(Figure 4)**. **NOTE:** Insert Hex Bolts in through the pinch weld first and then the Bracket. **IMPORTANT:** Cradles on the (3) cab Mounting Brackets **face forward**, **(Figure 18)**.

Driver Side Installation Pictured

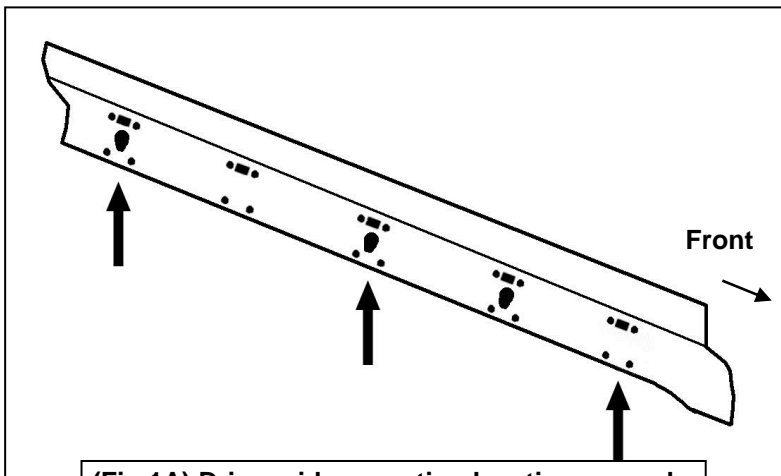

(Fig 1A) Driver side mounting locations on cab

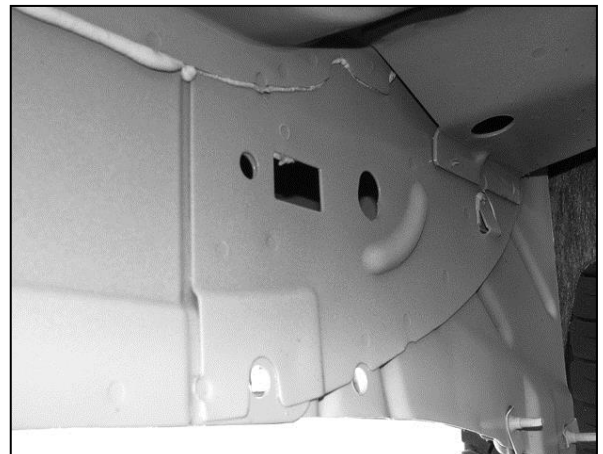

(Fig 1B) Driver side front mounting location

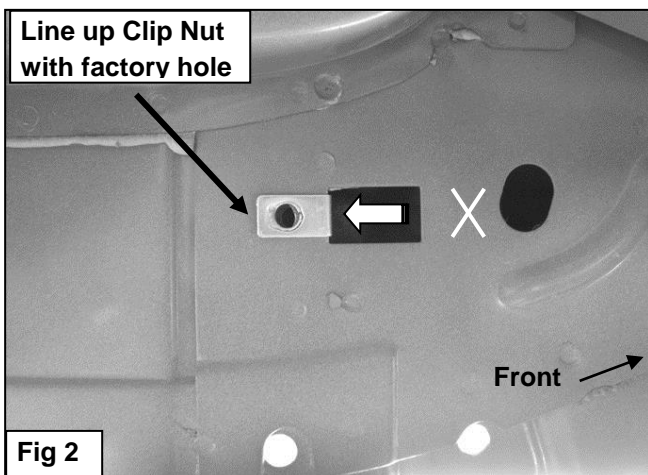
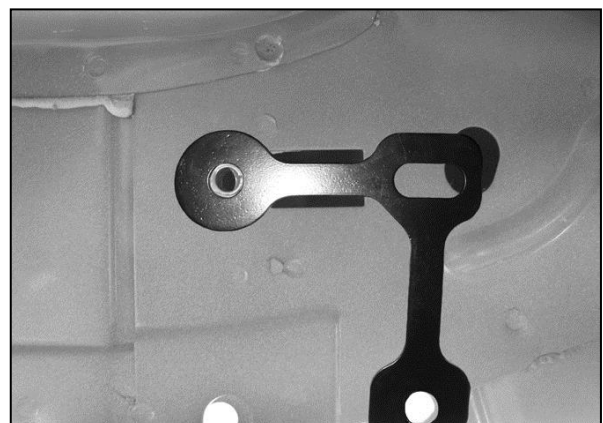
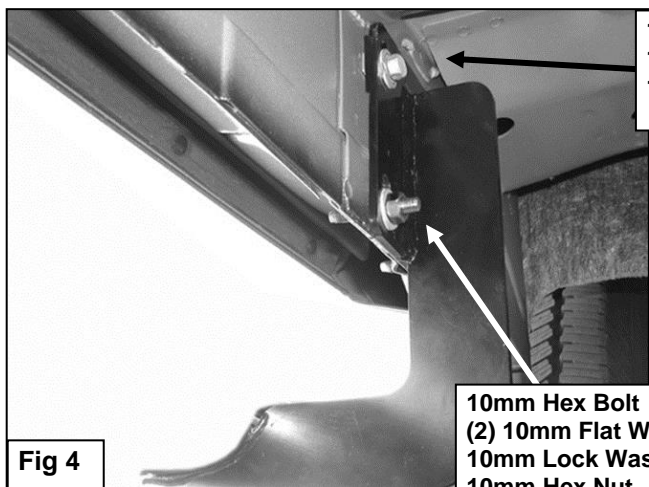

Fig 2



(Fig 3) Front Bracket Spacer on driver side

4. Move to the center, (3rd), mounting location along the pinch weld. Select (2) 10mm Clip Nuts. Insert the Clip Nuts into the rectangular opening and over the round holes as described in **Step 3, (Figures 5 & 6)**. Select (1) driver side Bracket. Attach the Bracket to the Clip Nuts with (2) 10mm Hex Bolts, (2) 10mm Lock Washers and (2) 10mm Flat Washers. Attach the Bracket to the pinch weld with (2) 10mm Hex Bolts, (4) 10mm Flat Washers, (2) 10mm Lock Washers and (2) 10mm Hex Nuts, (**Figure 7**).
5. Repeat **Step 5** to attach the driver side Bracket to the last mounting location at the back of the cab.



10mm Hex Bolt
10mm Lock Washer
10mm Flat Washer

10mm Hex Bolt
(2) 10mm Flat Washers
10mm Lock Washer
10mm Hex Nut

Fig 4

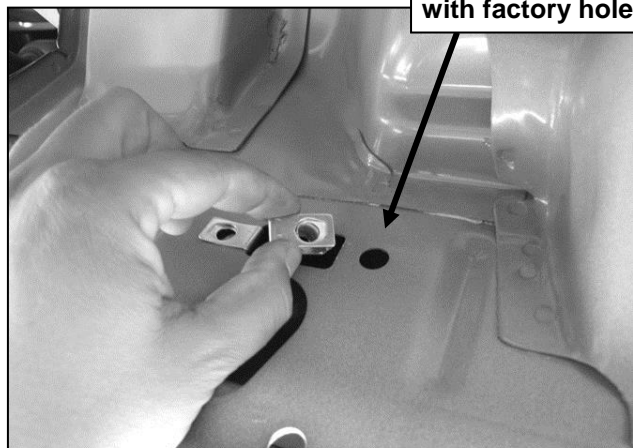

Line up Clip Nut with factory hole

(Fig 5) Example center or rear mounting location

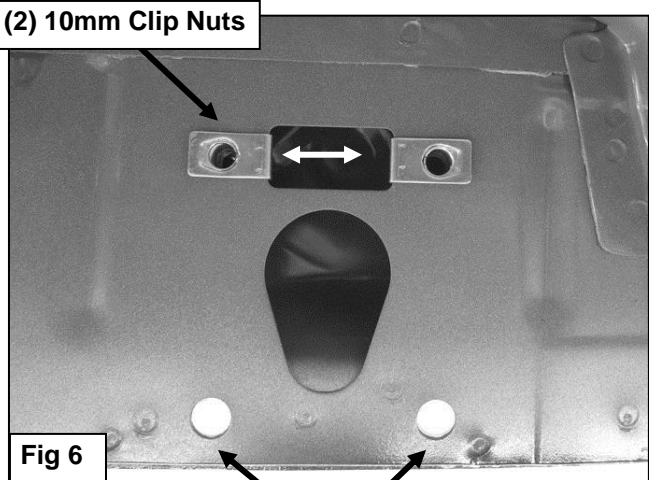

(2) 10mm Clip Nuts

Fig 6

Factory holes in pinch weld

10mm Hex Bolt
(2) 10mm Flat Washers
10mm Lock Washer
10mm Hex Nut

10mm Clip Nuts
10mm Hex Bolts
10mm Flat Washers
10mm Lock Washers

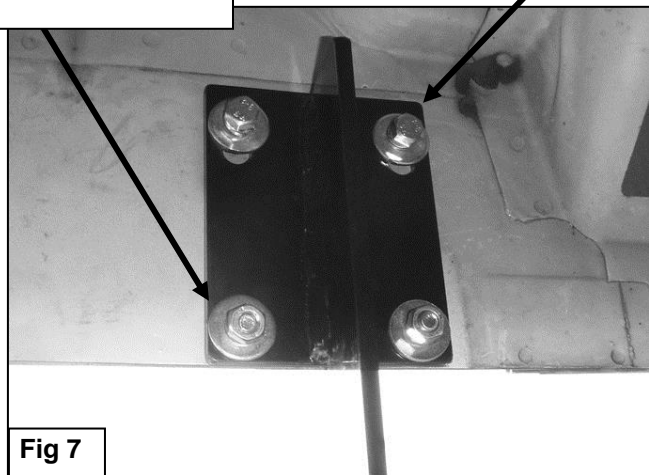

Fig 7

IMPORTANT: the Bolt Plate installation pictured in Figures 8—12 applies only to:
1999-2010 Driver side bed and support bracket
1999-2015 Passenger side bed and support bracket

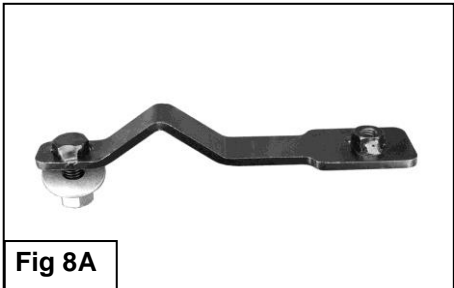
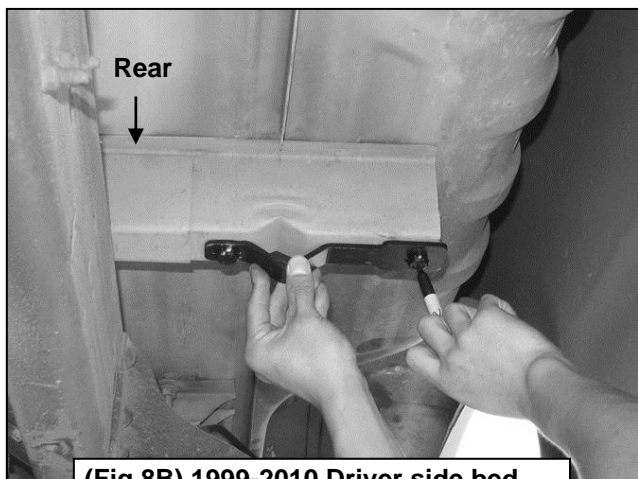

Fig 8A

6. Select the correct procedure for installing the rear Bed Mounting Bracket assembly under the bed:
1999-2010 Driver side rear bed mounting Bracket assembly:

- a. Locate the square reinforcing tube welded to the bottom of the bed above and in front of the rear tire. Select (1) 12mm Bolt/10mm Nut Plate, **(Figure 8A)**. Hold the Bolt/Nut Plate upside-down against the bottom of the tube with the 12mm Bolt inserted into the oval hole, **(Figure 8B)**. Mark the location of the Nut onto the bottom of the tube. Drill the location with a 7/16" Drill Bit.
- b. Insert the Bolt/Nut Plate into the tube with the 12mm Bolt out through the factory hole, **(Figures 10, 12B & 14B)**. Line up the 10mm Nut with the drilled hole in the tube.
- c. Select the driver side Bed Mounting Bracket, **(Figure 9)**. Attach the Bracket to the 12mm Bolt on the Bolt/Nut Plate with a 12mm Flat Washer, 12mm Lock Washer and 12mm Hex Nut, **(Figures 10 & 12B)**. Leave loose at this time.
- d. Select the 1999-2010 driver side Rear Support Bracket, **(Figure 11)**. Bolt the Bracket to the bottom of the tube and the Bolt/Nut Plate with (1) 10mm Hex Bolt, (1) 10mm Lock Washer and (1) 10mm Flat Washer, **(Figures 12A & 12B)**. Attach the lower end of the Support Bracket to the front side of the Mounting Bracket with (1) 10mm Hex Bolt, (2) 10mm Flat Washers, (1) 10mm Lock Washer and (1) 10mm Hex Nut, **(Figure 12B)**. Do not tighten hardware at this time.



(Fig 8B) 1999-2010 Driver side bed Mounting Bracket Bolt Plate pictured



(Fig 9) Driver side bed Mounting Bracket

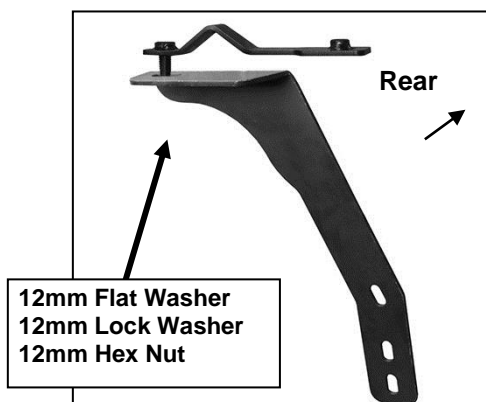

(Fig 10) Attach Bracket to Bolt/Nut Plate

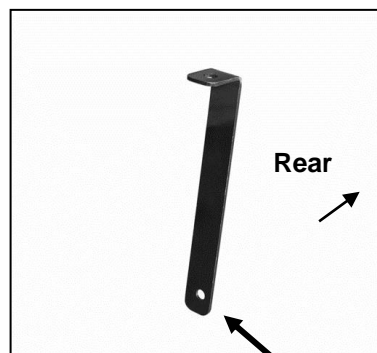

(Fig 11) 1999-2010 Driver side Support Bracket pictured. Note slightly offset hole on bottom of bracket

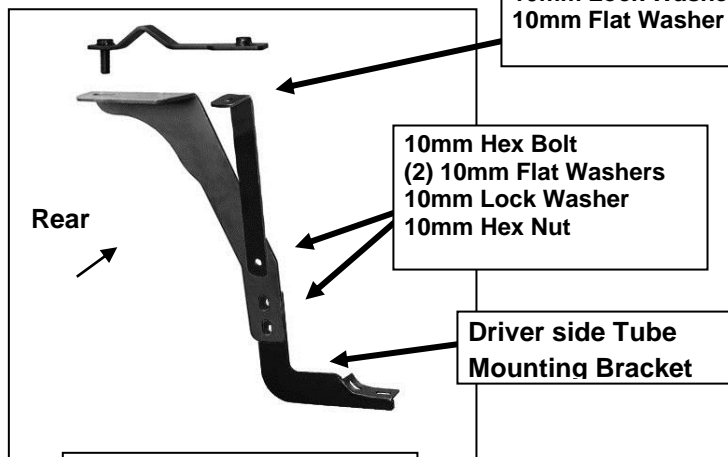

(Fig 12A) Attach Support Bracket to Bolt/Nut Plate



(Fig 12B) 1999-2010 Complete driver side bed Mounting Bracket assembly pictured

1999-2015 Passenger side rear mounting Bracket assembly:

- a. Repeat the previous 99-2010 driver side procedure (**Steps 7a—d**) for 1999-2015 passenger side rear bed bracket installation. Once completed, skip to **Step 8**.

2011-2015 Driver side only rear mounting Bracket assembly:

- a. Release the plastic vent tube from the factory bracket, (**Figure 13**). Remove the plastic bracket from the square tube welded to the bottom of the bed. Insert the 2011-15 12mm Bolt Plate into the end of the tube and out the factory hole in the bottom, (**Figures 14A & 14B**). Reinstall the plastic bracket and vent tube, (**Figure 15**).
- b. Select the driver side Bed Mounting Bracket. Attach the Bracket to the 12mm Bolt on the Bolt Plate with (1) 12mm Flat Washer, (1) 12mm Lock Washer and (1) 12mm Hex Nut, (**Figures 16 & 17B**). Leave hardware loose at this time.
- c. Select the driver side 2011-15 Rear Support Bracket, (**Figure 17A**). Attach the 90-deg bent end of the Support Bracket to the hole in the top of the leaf spring bracket with (1) 12mm x 35mm Hex Bolt, (2) 12mm Flat Washers, (1) 12mm Lock Washer and (1) 12mm Hex Nut, (**Figure 17B & 17C**). Bolt the flat end of the Bracket to the front of the Bed Bracket with (1) 10mm Hex Bolt, (2) 10mm Flat Washers, (1) 10mm Lock Washer and (1) 10mm Hex Nut, (**Figure 17B**). Leave hardware loose at this time.

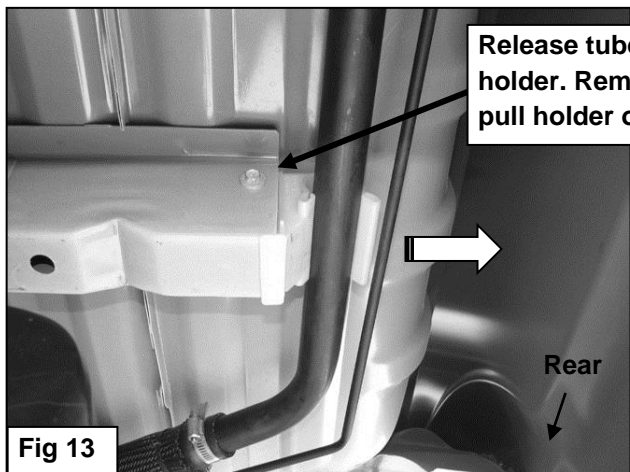

Release tube from plastic holder. Remove screw and pull holder out of square tube

Fig 13



(Fig 14A) 2011-15 Driver side bed Mounting Bracket Bolt Plate only

IMPORTANT: Figures 13—18 apply to 2011-15 Driver side bed Mounting Bracket only

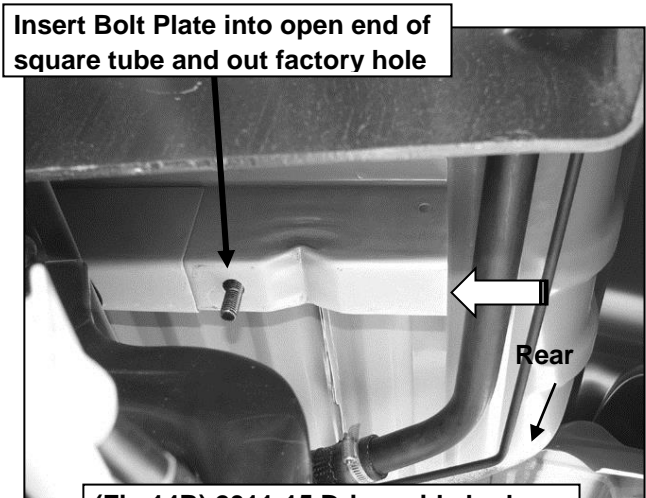

Insert Bolt Plate into open end of square tube and out factory hole

(Fig 14B) 2011-15 Driver side bed Mounting Bracket Bolt Plate pictured

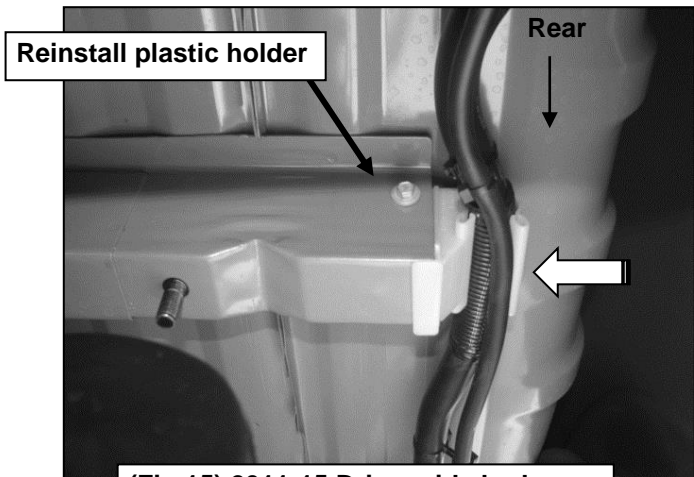

Reinstall plastic holder

(Fig 15) 2011-15 Driver side bed Mounting Bracket Bolt Plate pictured

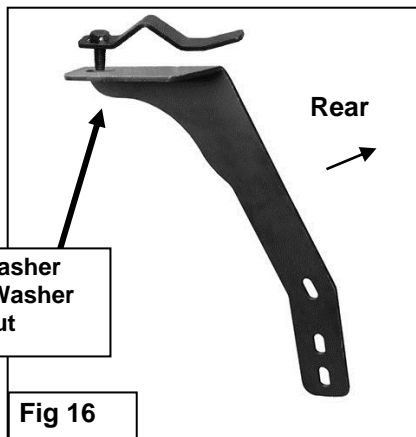

12mm Flat Washer
12mm Lock Washer
12mm Hex Nut

Fig 16

7. Once the upper Bed Mounting Bracket assembly has been completely installed, select the driver side Tube Mounting Bracket, (**Figures 12A, 12B & 17B**). **NOTE:** The cradle on the Tube Bracket will face the **rear of the vehicle**. Bolt the Bracket to the back of the upper Bracket assembly with (2) 10mm Hex Bolts, (4) 10mm Flat Washers, (2) 10mm Lock Washers and (2) 10mm Hex Nuts, (**Figures 12A, 12B & 17B**). Snug but do not tighten hardware.
8. With assistance, carefully place the Sidebar into position on the Brackets. **NOTE:** Bent end of Sidebar toward front. Attach the Sidebar to the (4) Bracket cradles with (8) 8mm x 25mm Hex Bolts, (8) 8mm Lock Washers and (8) 8mm Flat Washers, (**Figure 18**).
9. Level and align the Sidebar with the side of the vehicle and tighten all hardware.
10. Repeat **Steps 2—10** for passenger side Mounting Bracket and Sidebar installation, (See **Step 7** for passenger side bed Mounting Bracket specific information).
11. Periodically check and retighten the hardware as necessary.

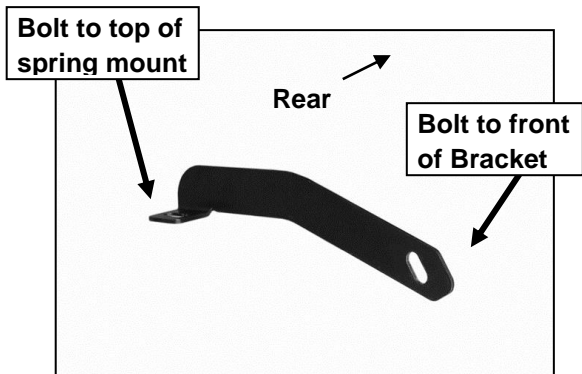

(Fig 17A) 2011-15 driver side rear Support Bracket for Bed Mounting Bracket

12mm x 35mm Hex Bolt
(2) 12mm Flat Washers

2011-15 driver side rear Support Bracket



(Fig 17C) Bolt the 2011-15 driver side rear Support Bracket to the top of the rear spring mount

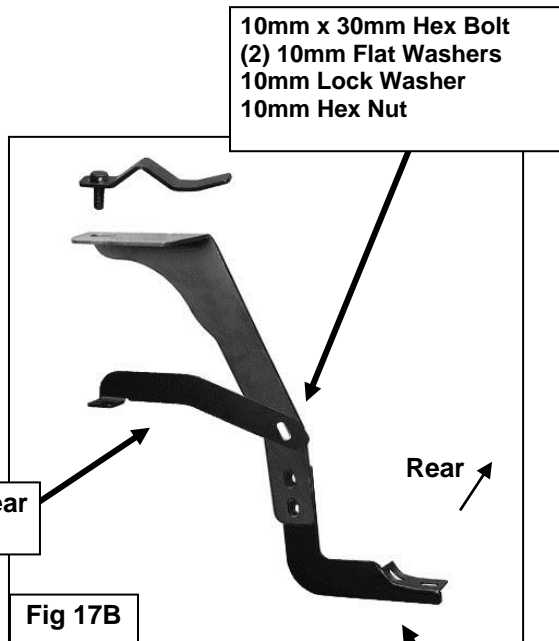

Fig 17B

Driver side Tube Mounting Bracket



Complete Installation

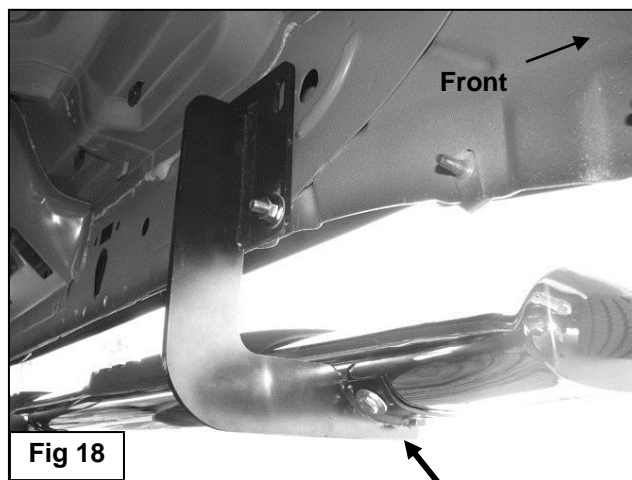

Fig 18

(2) 8mm x 25mm Hex Bolts
(2) 8mm Lock Washers
(2) 8mm Flat Washers

PARTS IDENTIFICATION GUIDE

Driver Side tube packed using "Green" color foam sheet. Passenger Side tube packed using "White" color foam sheet

| No. | Parts Identification |
|-----|--|
| 1 | Passenger / Right 'Rear' Bracket marked "PR" |
| 2 | Driver / Left 'Rear' Bracket marked "DR" |
| 3 | Passenger / Right 'Center' Bracket marked "PC" |
| 4 | Driver / Left 'Center' Bracket marked "DC" |
| 5 | Passenger / Right 'Front' Bracket marked "PF" |
| 6 | Driver / Left 'Front' Bracket marked "DF" |

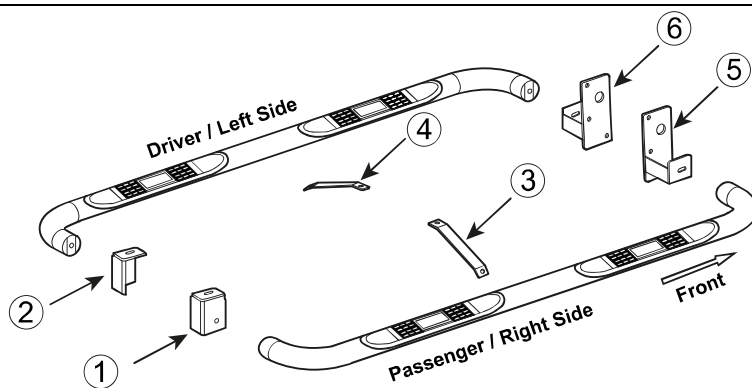
**Note:**

- This guide is to identify the parts and not a reference for part count.
- For part count, refer Parts List.
- Product / Bracket image is representative and actual design may vary.

PRODUCT CARE

- Periodically check the product to ensure all fasteners are tight and components are intact.
- Regular waxing is recommended to protect the finish of the product.
- **Use ONLY Non-Abrasive automotive wax.** Use of any soap, polish or wax that contains an abrasive is detrimental and can scratch the finish leading to corrosion.
- Aluminum polish may be used to polish small scratches and scuffs for **Stainless Steel finish.**
- Mild soap may be used to clean the product for both **Stainless Steel and Black finish.**

FAQ's**1. Hardware's are not of correct size.**

In GMC / Chevrolet truck model 2006 & up, customer needs to reuse the factory body bolts to install the bracket. If your vehicle is not GMC / Chevrolet 2006 & up, ensure that holes are not partially covered with any plastic grommet or rust? If it is, remove the plastic grommet & rust from the thread holes & re-try the installation.

2. Mounting Bracket are not getting Installed properly.

In some cases Illustration images shown in Installation manual may not be the exactly same as per actual vehicle images ,also if Driver / Passenger side mounting brackets are very identical in the design, suggest referring Parts Identification guide to avoid fitment issue.

3. Products are thumping / rattling after installation.

Ensure that all required mounting brackets / hardware's are installed & tighten correctly. Suggest using white lithium / regular grease between the metal to metal contact surfaces.

4. Side Bar is not aligning with vehicle / Step Pads are not aligning with vehicle doors.

Side bar may be interchanged or mounting brackets are not installed at the correct position in the vehicle. Refer Parts identification guide.

5. Missing / Excess Hardware.

Recheck hardware count as per the part list.

6. Product not installing properly.

Ensure make model year, cab length and bed size of your vehicle is listed in the application. All installation steps are followed correctly.

Check out these other TrailFX Products!!

www.TrailFX.com

**BULL BAR****GRILLE GUARDS****BED RAILS****RUNNING BOARDS**

Keystone Automotive Operations Inc. (KAO) warrants this product to be free of defects in material and workmanship at the time of purchase by the original retail consumer. KAO disclaims any other warranties, express or implied, including the warranty of fitness for a particular purpose or an intended use. If the product is found to be defective, KAO may replace or repair the product at our option, when the product is returned prepaid, with proof of purchase. Alteration to, improper installation, or misuse of this product voids the warranty. KAO's liability is limited to repair or replacement of products found to be defective, and specifically excludes liability for any incidental or consequential loss or damage.