



INSTALLATION GUIDE

PART NUMBER: 5551
REAR ANTI-SWAY BAR
FORD F-150 2WD | 2009-2013

****USE ONLY ON VEHICLES LOWERED WITH A FLIP KIT****

300 W. PONTIAC WAY CLOVIS, CA 93612
PHONE: 800-445-3767 | EMAIL: INFO@BELLTECH.COM

THANK YOU

Thank you for choosing our high quality Belltech product. We have spent a great deal of time developing our line of products so that you will receive maximum performance with minimal difficulty during installation. Soon your vehicle will be on the road looking and feeling much improved.

Please take a moment to read all instructions and warnings prior to installation of your new Belltech product and before operating your vehicle. If you have any questions or concerns regarding any step in the installation process, please do not hesitate to call or email our customer support specialists who are trained to help you through any portion of this process.

Before You Begin:

It is of the utmost importance that you confirm all the components listed on the parts list are in the kit. You can find this list located on the last page(s) of your instructions. Do not begin installation if any part is missing. Instead, please call our Belltech customer service specialists.

Belltech Customer Support:

Phone: 1-800-445-3767

Email: info@belltech.com

Safety Information:

Warning: Do not work under a vehicle supported only by a jack. Place support stands securely under the vehicle in the manufacturer's specified locations unless otherwise instructed.

Proper use of safety equipment and eye/face/hand protection is necessary when performing any of the following instructions.

We strive for an exceptional experience for all our valued customers. If for any reason you need assistance with your Belltech products, please do not return the product to the store you purchased from, but rather call our dedicated customer service experts, from 7am to 5pm PST.

We recommend that a qualified mechanic, in a properly equipped facility, perform this installation.

It is very helpful to have an assistant available during installation.

Before Driving Your Vehicle:

It is important to double check all brake hoses, cables, and other components to be sure there is no interference. You must also check for wheel/tire to chassis/body interference. If any issues are found, review your installation instructions to be sure no steps were missed, and any problems are corrected.

Make sure your vehicle is aligned immediately following installation.

Check all hardware and torque at intervals for the first 10, 100, and 1000 miles.

Some of Belltech's products are designed to improve your vehicle's off-road performance. Leveling/lifting your vehicle may result in an altered center of gravity. It is crucial to use extreme care when operating your vehicle to prevent rollover and/or loss of control.

Any changes in your vehicle's suspension may result in transformed handleability. Please test-drive your vehicle in a remote location so you can become accustomed to the revised driving characteristics.

Perform headlight check and adjustment.

Failure to drive any modified vehicle in a safe manner may result in harm or death.

Never operate your modified vehicle under the influence of drugs, alcohol, or lack of adequate sleep.

Always wear your seatbelt.



DIFFICULTY:



INSTALLATION TIME: 1-2 Hours

RECOMMENDED TOOLS:

- Properly rated floor jack
- Support stands
- Wheel chocks
- Metric and standard socket wrench set
- Metric and standard wrench set
- Drill with drill bit set
- Abrasive cutting tool or grinder
- Safety glasses
- Torque wrench rated up to 180 ft lbs.

JACKING, SUPPORTING, AND PREPARING THE VEHICLE

1. Park your vehicle on a smooth, level, concrete, or seasoned asphalt surface.
2. Block the front wheels of the vehicle using wheel chocks. Make sure the vehicle's transmission is in "PARK" (automatic) or first gear (manual).
3. Activate the parking brake.
4. Loosen, but do not remove, the rear wheel lug nuts.
5. Lift the rear of the vehicle off the ground using a properly rated floor jack. Lift the vehicle so the rear tires are approximately 6-8 inches off the ground.
6. Place support stands rated for the vehicle's weight. The stands must be positioned in the factory specified locations. (Refer to the owner's manual). Prior to lowering the vehicle onto stands, make sure the support stands will contact the chassis. It is very important that the vehicle is properly supported to prevent any harm to oneself or to the vehicle.
7. Lower the vehicle slowly onto the stands.
8. Remove the rear wheels.



Technician reminder:

Never work under a vehicle supported only by a jack. It is necessary to place support stands securely under the vehicle in the manufacturer's specified locations unless otherwise instructed.

BELLTECH ANTI-SWAY BAR INSTALLATION

- Remove the upper shock mount nut and bolt using an 18mm wrench and a 15mm socket wrench. Remove any debris or build up from the outer edges of the shock mount.

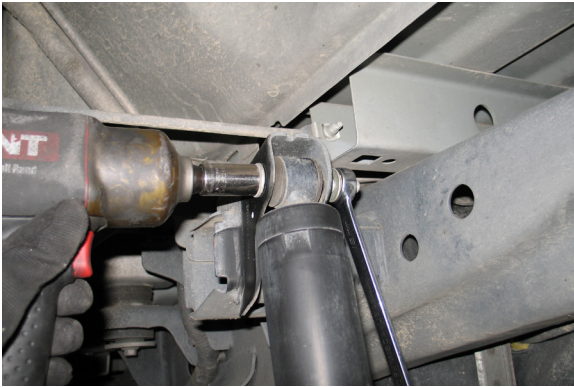

- Grind off the excess tab material shown painted in yellow.

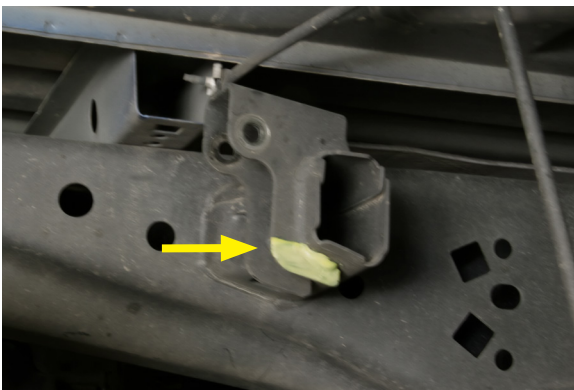

- Position the end link bracket up against the inside flange, centered on the cross beam. Mark the hole location to be drilled.



- Using a 17/32-inch drill bit and power drill, make a hole in the marked location.
- Fasten the end link bracket with a supplied 1/2"-20 X 1-1/4" bolt, a 1/2" X 20 stover lock nut, and a 1/2" washer.
- Ensure the end link bracket is parallel to the frame rails. Torque the end link bracket on the cross beam to 80 ft lbs.

BELLTECH ANTI-SWAY BAR INSTALLATION CONTINUED

- Place the shock in the original position on the upper shock mount and fasten with the original nut and bolt. Torque to 66 ft lbs.
- Attach Belltech end link to the end link bracket and fasten with a supplied 3/8"-16 X 2-3/4" bolt, a 3/8"-16 Nyloc nut, and 3/8" washers on each side of the bracket as shown below. Hand tighten, do not torque yet.

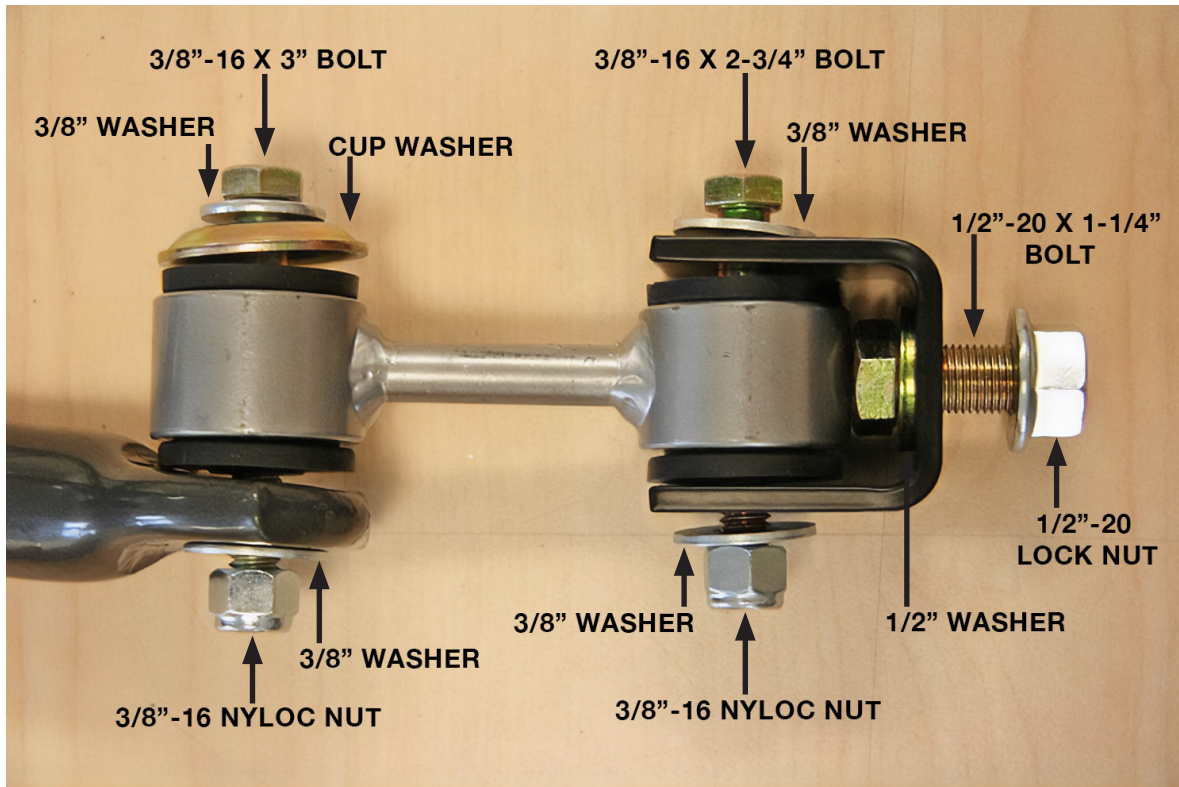

- Locate the hydraulic brake line on the driver side of the rear axle. Use a pry tool to detach the line from the locator clip.



BELLTECH ANTI-SWAY BAR INSTALLATION CONTINUED

18. Thoroughly lubricate the inside of the supplied pivot bushings using the grease packet included with the kit.
19. Place the bushings on both sides of the Belltech sway bar, centered on the first set of bends. Once located, rotate the bushings slightly to evenly spread the lubricant. Place the bushing brackets over the bushings.



20. Ensure there is 1/32" to 1/16" of the bushing is showing after the bracket is seated. If the bushing is showing more than 1/16", use a sander or a sheet of coarse grit sandpaper to shave it down to the proper height.

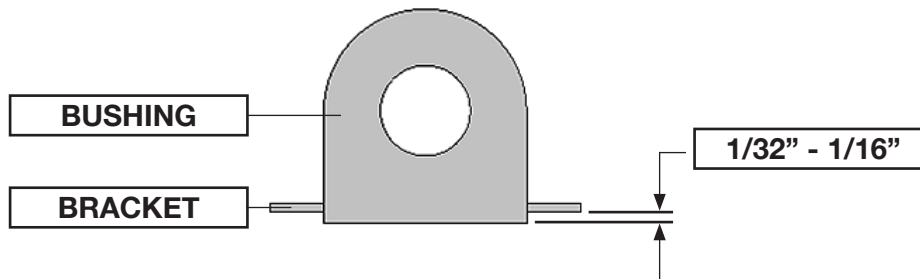

21. Position the sway bar under the vehicle with the bar ends pointed forward and angled above the leaf springs.
22. Carefully bend the hydraulic line away from the axle and place the U-bolts over the axle tube and under the brake line, ensuring the brake line is not clamped underneath. Place the U-clamp on the U-bolt followed by the support plate. Mount the sway bar and bushing bracket on the U-clamp. Hand tighten one of the supplied nuts on the U-bolt and leave one side off for now. Ensure the sway bar is positioned below the axle.

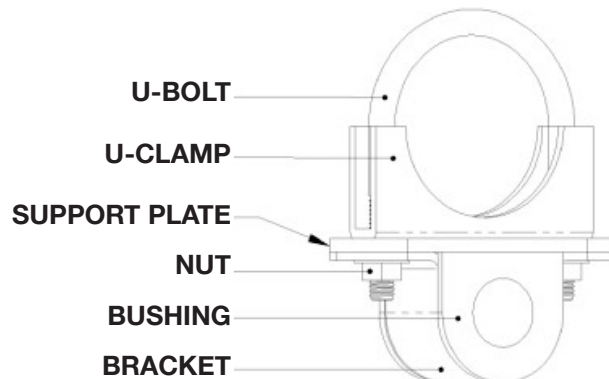

BELLTECH ANTI-SWAY BAR INSTALLATION CONTINUED

23. Attach the lower end link to the Belltech sway bar. The end link must be placed outboard of the sway bar. Use a 3/8"-16 X 3" bolt, a 3/8"-16 Nyloc nut, a cup washer, and two 3/8" washers. The cup washer is placed on the opposite side of the end link. Torque the upper and lower end link bolts to 40 ft lbs.

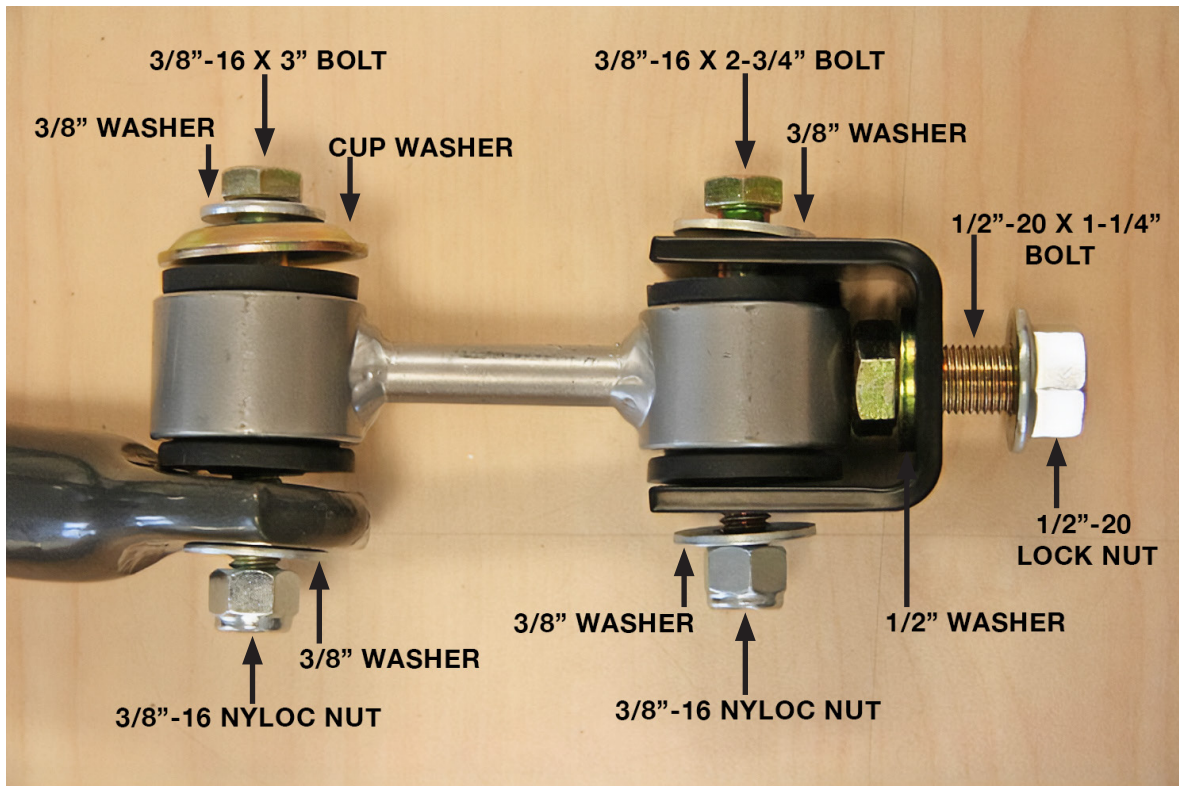

24. Ensure the sway bar is centered from side to side and sits below the axle. Torque the U-bolts to 19 ft lbs.



FINALIZING THE INSTALLATION

25. Mount the wheels and tighten the lug nuts
26. Lift the vehicle and remove the support stands.
27. Carefully lower the vehicle onto flat ground.
28. Torque the lug nuts to 150 ft lbs.
29. Check that all components and fasteners have been properly installed and torqued.
30. Read and perform all tasks in the “Before Driving Your Vehicle” section of page 1 of your instructions.

THANK YOU FOR CHOOSING BELLTECH.

You are now a part of the Belltech family and we are eager to catch a glimpse of your newly modified vehicle. Give us a shout out and let us know how much you love our product. Don't forget, we offer other Belltech related merchandise for you and your vehicle on our website www.belltech.com

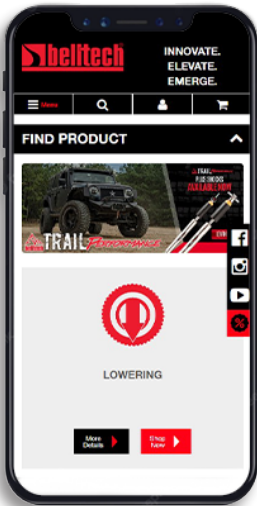

[belltechsuspension](https://www.facebook.com/belltechsuspension)



[Belltech Suspension](https://www.youtube.com/BelltechSuspension)



[@belltechsuspension](https://www.instagram.com/belltechsuspension)

If you have any questions, concerns, or warranty related issues regarding your Belltech product, please call or email our experienced customer service specialists.

Belltech Customer Support:

Phone: 1-800-445-3767

Email: info@belltech.com

KIT CONTENTS



SWAY BAR KIT		
Part number	Description	Qty
5551-300	1" REAR ANTI-SWAY BAR	1
5551-777	HARDWARE KIT	1

HARDWARE KIT		
Part number	Description	Qty
110255	3/8"-16 NYLOC NUT	6
110402	1/2"-20 STOVER LOCK NUT	2
112110	3/8"-16 X 2-3/4" BOLT	2
112112	3/8"-16 X 3" BOLT	2
110408	1/2"-20 X 1-1/4" BOLT	2
112518	3/8" WASHER	10
110660	1/2" WASHER	2
7000-896	CUP WASHER	2
5551-004-99	END LINK BRACKET	2
114051	END LINK	2
112260	3-1/4" U-CLAMP ASSEMBLY	2
113075	1" PIVOT BUSHING	2
115002-95	PIVOT BUSHING BRACKET	2
115003-95	BUSHING SUPPORT PLATE	2
55000-10	WHITE LITHIUM GREASE	1