



## ***Alumilite Steps***

**part# 840121412906**

### **DIRECTIONS FOR INSTALLATION & USE**

***2018- 2021 Jeep JL- 4 door***

*For technical support,*

**call 1-800-626-8746 or email [sales@icionline.com](mailto:sales@icionline.com)**

***visit [icionline.com](http://icionline.com) to download instructions***



**ATTN: STATE OF CALIFORNIA CONSUMERS  
WARNING: CANCER AND REPRODUCTIVE HARM  
-WWW.P65WARNINGS.CA.GOV**



**WARNING: FAILURE TO COMPLY WITH INSTALLATION,  
SAFETY, AND PRODUCT USE INSTRUCTIONS MAY RESULT IN  
SERIOUS BODILY INJURY OR DEATH.**

## **IMPORTANT NOTES**

The contents of this installation and operation manual should be read and comprehended before initializing the installment of the above listed product. This will help minimize risk to injury through the installation process and through the operation of the product.

## **TABLE OF CONTENTS**











1. SAFETY, WARNINGS, AND OPERATION .....	02
2. PARTS AND TOOLS REQUIRED .....	03
4. REFERENCE DIAGRAM. ....	04
5. ICI STEP INSTALLATION. ....	05-08
6. SOCIAL MEDIA REFERENCE .....	.08



## SAFETY, WARNINGS, AND OPERATION

- Please ensure that the installer and end-user of this product have familiarized themselves with the contents in this manual. This manual provides important information about the possible safety and operation risks that are involved with the usage of this product.
- Our number one concern is the safety of our customers. This product is intended to be installed by a professional to minimize risk of an improper installation. Improper installations can lead to product damage, vehicle damage, and bodily injury. We ask that you reach out for professional assistance if this installation is beyond your capabilities.
- Please ensure to safeguard this installation and operation manual to reference in the future or to pass on to a future owner of the product.
- Please follow all instructions and take all safety precautions necessary throughout the entirety of the installation process.

## PARTS AND TOOLS REQUIRED

SYMBOL	DESCRIPTION	TOOL	DESCRIPTION
	HAZARDOUS WARNING		RATCHET/SOCKET WRENCH
	WARNING: SHARP ELEMENTS		SOCKETS : 10mm and 13mm
	WARNING: CRUSHING OF HANDS		10mm and 13mm
	WARNING: HOT SURFACE		(Allen wrench included)
	MANDATORY: WEAR EYE PROTECTION		EYE PROTECTION

## PARTS AND TOOLS REQUIRED

### Hardware Kit includes:

**(1). Qty x 16 = M8 Finish Washers**

**(2). Qty x 6 = M8 x 28 x 3mm Flat Washers**

**(3). Qty x 24 = M6 x 22 x 2mm Flat Washers**

**(4). Qty x 6 = M8 Lock Washers**

**(5). Qty x 16 = M8 x 24 x 2mm Flat Washers**

**(6). Qty X 16 = M8 x 35mm Hex Countersunk Bolts**

**(7). Qty x 6 =M8 x 35mm Hex Head Bolts**

**(8). Qty x 12 = M6 x 25mm Hex Head Bolts**

**(9). Qty x 16 = M8 Nylock Nuts**

**(10). Qty x 12 = M6 Nylock Nuts**

### Components List:

**(a). Side Bars - Qty x 2  
1 Driver / 1 Passenger**

**(b). Front Brackets - Qty x 2  
1 Driver / 1 Passenger (100529)**

**(c). Middle Brackets - Qty x 2  
1 Driver / 1 Passenger (100530)**

**(d). Rear Brackets - Qty x 2  
1 Driver / 1 Passenger (100531)**

**(e). Hoop Steps - QTY x 4**

## REFERENCE DIAGRAM

### ***DRIVER SIDE example below:***

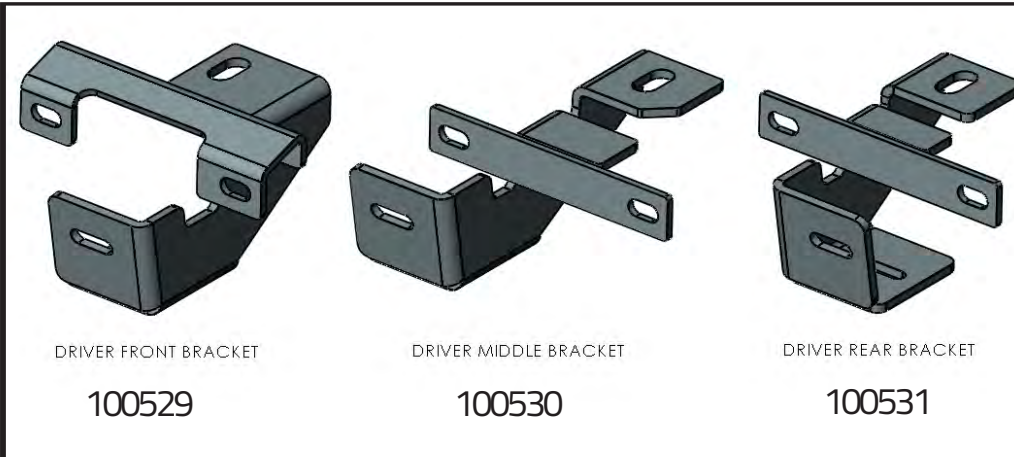
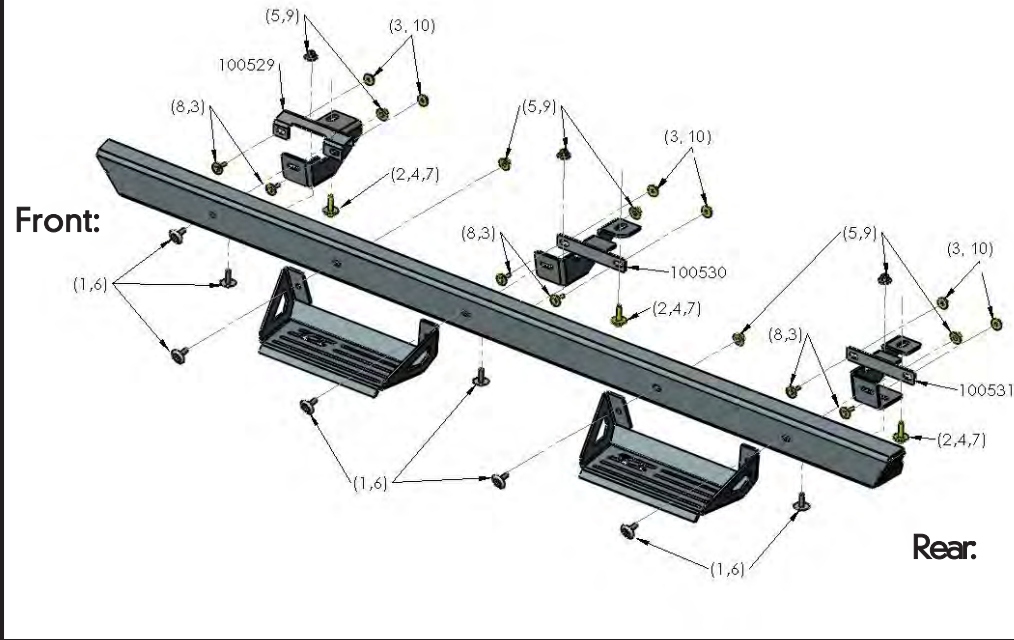

## ICI STEP INSTALLATION

### Step 1 (Prep)

Beginning on the Driver's side, remove any steps if equipped. Next, locate the 3 sets of mounting points on the underside of the vehicle. Please note that your vehicle may have tape, plugs, and/or factory bolts covering up the mounting locations. These will need to be removed so that the mounting locations can be accessed. Keep any OE hardware to reuse during installation.

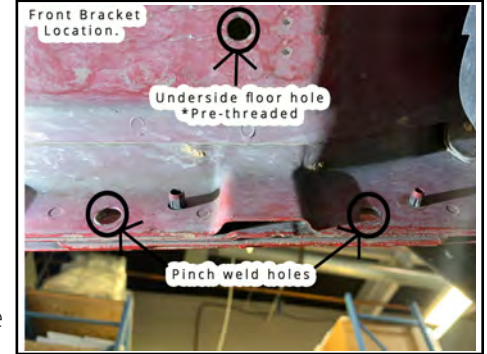

Figure 1.

### Step 2 (Install Brackets to Jeep)

Begin with the driver front bracket 100529, loose fit. For the 2 pinch weld holes, you will need (2 sets) of M6x25mm hex head bolts, M6 Nylock Nuts, and (2) of M6x22x2mm flat washers. Use a 10mm socket. For the floorboard hole, you will need (1 set) of M8x28x3mm flat washer, M8 lock washers, and M8x35mm hex head bolts. Use a 13mm socket. Once the front bracket is attached, move on to the middle bracket, then the rear bracket, repeating the steps above.

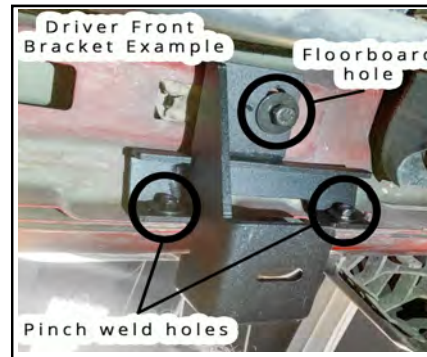

Figure 2.

### Step 3 (Hang bar on Brackets)

Next, locate the driver side bar, the distance from the front of the bar to the first step hoop is greater than the distance from the rear of the bar to the second step hoop, reference the diagram on page 6. The top of the bar has a small lip, use the lip to hang the bar on the brackets. This will make the installation process easier and hands-free.



Figure 3.



## ICI STEP INSTALLATION



Figure 4.

### Step 5 (Finish Bolt Front Hoop Step to Bar)

Next, finish bolting the front hoop step to bar. Use (1 set) of M8 finish washers, M8x24x2mm flat washers, M8x35mm hex countersunk bolts, and M8 Nylock Nuts. Use a 13mm socket and the provided Allen wrench. Do not fully tighten.



Figure 5.

### Step 6 (Bolt Front Bracket to Bar)

Next, bolt the front bracket (100529) to the bar. Use (2 sets) of M8 finish washers, M8x24x2mm flat washers, M8x35mm hex countersunk bolts, and M8 Nylock Nuts. Use a 13mm socket and the provided Allen wrench. Do not fully tighten. See diagram on page 6 for reference.



Figure 6.

### Step 4 (Bolt Middle Bracket to Bar and Front Hoop Step)

Bolt the front hoop step to the bar and middle bracket (100530). View diagram on page 6. Note that the hoop step and middle bracket share a bolt. Use (2 sets) of M8 finish washers, M8x24x2mm flat washers, M8x35mm hex countersunk bolts, and M8 Nylock Nuts. Use a 13mm socket and the provided Allen wrench. Do not fully tighten.

## ICI STEP INSTALLATION

### STEP 7 (Bolt Rear Hoop Step to Bar and Rear Bracket)

Repeat steps 4 and 5 for the rear hoop step and rear bracket (100531). Note that the rear bracket and hoop step share a bolt in the very rear. See the diagram on page 6 for reference.

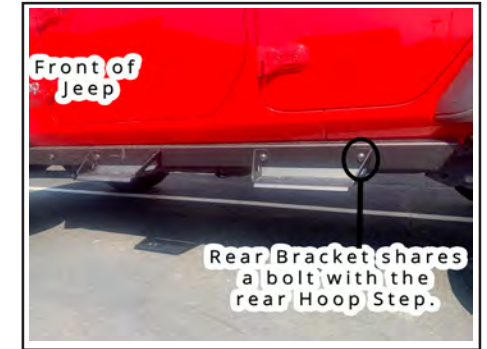

Figure 7.

### STEP 8 (Tighten Brackets to Truck)

Make sure all 3 brackets, the bar, and the 2 hoops steps are loosely fitted to each other and to the vehicle. Using a 10mm and 13mm socket, fully tighten the front bracket to the vehicle, make sure the bracket is flush with the mounting surface. Repeat on the middle and rear bracket checking the bracket alignment as needed.

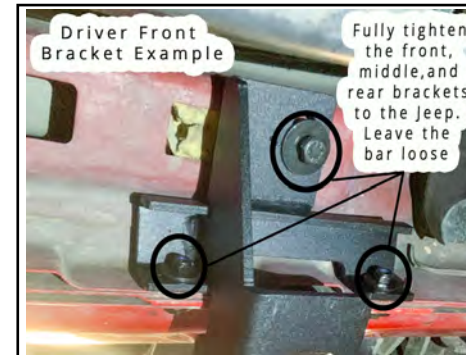

Figure 8.

### STEP 9 (Tighten Brackets to the Bar and Hoop-Steps)

Now, adjust the bar from front to back and tighten the bar to the brackets with a 13mm socket and provided Allen wrench. Make sure the bar is flush with the front and bottom face of the brackets as you are tightening them.



Figure 9.

**\*PRO TIP:** When tightening the Finish Washers, hold the Allen Key tight so the Bolt does not spin. Then, tighten the Nut on the backside. This will prevent the Bolt and Finish Washer from spinning and scratching the Bar.

## ICI STEP INSTALLATION

### STEP 10 (Finish)

Check all hardware and make sure they are fully tightened. Reference diagram on page 3 for hardware locations. Repeat Steps 1-10 for the Passenger Side.



Figure 10.

**AMAZING!**

*Drop us a Review!*

*You have successfully completed the installation of your new Alumilite steps. Time to flex on your friends through Social Media! Don't forget to Tag us!*



[www.facebook.com/InnovativeCreationsInd](http://www.facebook.com/InnovativeCreationsInd)



[www.instagram.com/ici\\_usa](http://www.instagram.com/ici_usa)



*Hashtags:*

*#ICIUSA  
#ICIAlumilite  
#AlumiliteSteps  
#AlumiliteBumpers*