



***Alumilite Steps***  
**part# 840121412883**

**DIRECTIONS FOR INSTALLATION & USE**

***2005-2021 TOYOTA TACOMA (full 4-door)***

*For technical support,  
call **1-800-626-8746** or email **sales@icionline.com**  
visit **icionline.com** to download instructions*



**ATTN:** STATE OF CALIFORNIA CONSUMERS  
**WARNING:** CANCER AND REPRODUCTIVE HARM  
-WWW.P65WARNINGS.CA.GOV



**WARNING:** FAILURE TO COMPLY WITH INSTALLATION,  
SAFETY, AND PRODUCT USE INSTRUCTIONS MAY RESULT IN  
SERIOUS BODILY INJURY OR DEATH.

**IMPORTANT NOTES**

The contents of this installation and operation manual should be read and comprehended before initializing the installment of the above listed product. This will help minimize risk to injury through the installation process and through the operation of the product.

**TABLE OF CONTENTS**











1.SAFETY, WARNINGS, AND OPERATION .....	02
2.PARTS AND TOOLS REQUIRED .....	03
3.ICI STEP INSTALLATION. ....	04-06
4.SOCIAL MEDIA REFERENCE .....	07



## SAFETY, WARNINGS, AND OPERATION

- Please ensure that the installer and end-user of this product have familiarized themselves with the contents in this manual. This manual provides important information about the possible safety and operation risks that are involved with the usage of this product.
- Our number one concern is the safety of our customers. This product is intended to be installed by a professional to minimize risk of an improper installation. Improper installations can lead to product damage, vehicle damage, and bodily injury. We ask that you reach out for professional assistance if this installation is beyond your capabilities.
- Please ensure to safeguard this installation and operation manual to reference in the future or to pass on to a future owner of the product.
- Please follow all instructions and take all safety precautions necessary throughout the entirety of the installation process.

## PARTS AND TOOLS REQUIRED

SYMBOL	DESCRIPTION	TOOL	DESCRIPTION
	HAZARDOUS WARNING		RATCHET/SOCKET WRENCH
	WARNING: SHARP ELEMENTS		SOCKETS : 13mm
	WARNING: CRUSHING OF HANDS		13mm
	WARNING: HOT SURFACE		(Allen wrench included)
	MANDATORY: WEAR EYE PROTECTION		EYE PROTECTION

## PARTS AND TOOLS REQUIRED

### Hardware Kit includes:

- (1). Qty x 20 = M8 Nylock Nuts
- (2). Qty x 12 = M8 x 30mm Hex Head Bolts
- (3). Qty x 20 = M8 x 35mm Hex Countersunk Bolts
- (4). Qty x 32 = M8 x 24 x 2mm Flat Washers
- (5). Qty x 12 = M8 lock Washers
- (6). Qty x 20 = M8 Finish Washers
- (7). Allen Wrench included

### Components List:

- (a). Side Bars - Qty x 2  
1 Driver / 1 Passenger
- (b). Front Brackets - Qty x 2  
1 Driver / 1 Passenger (100532)
- (c). Middle/Rear Brackets - Qty x 4  
2 Driver / 2 Passenger (100533)
- (d). Hoop Steps (bolt on) - Qty x 4  
2 Driver / 2 Passenger (100524)

### Reference Diagram: DRIVER SIDE example below:

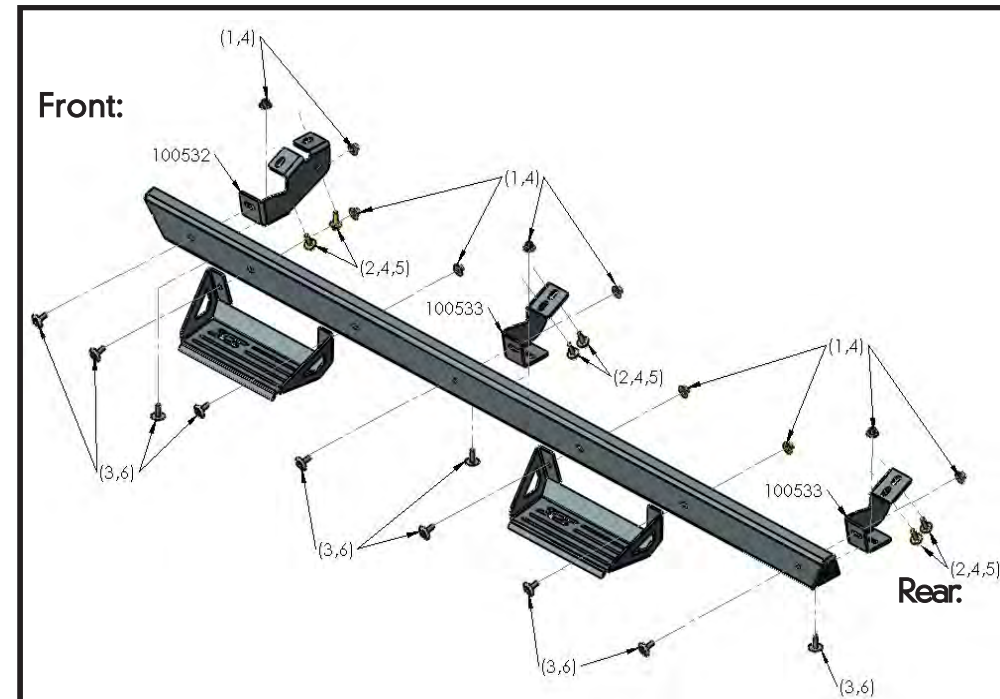

## ICI STEP INSTALLATION

### Step 1 (Prep)

Beginning on the Driver's side, remove any steps if equipped. Next, locate the 3 sets of mounting points on the underside of the vehicle (Fig. 1). Please note that your vehicle may have factory OE plastic bolts covering up the mounting locations. These will need to be removed so that the mounting locations can be accessed.

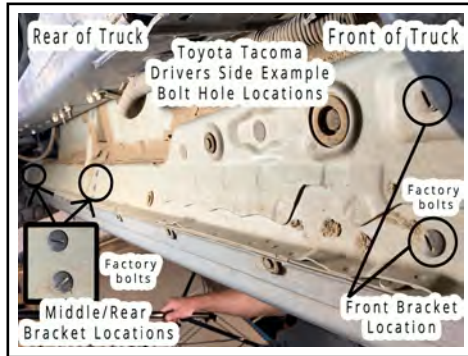

Figure 1.

### Step 2 (Install Brackets to Tacoma)

Begin with the driver front bracket 100532. Use (2 sets) of M8x30mm hex bolts, M8 flat washers, and M8 lock washers. Use a 13mm socket and do not fully tighten yet. Once the front bracket is attached, move on to the middle and rear brackets (100533), repeating the steps above for each bracket.

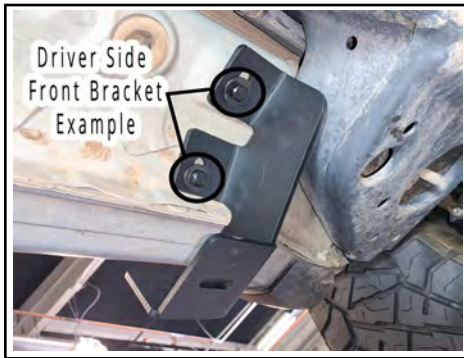

Figure 2.

### Step 3 (Hang bar on Brackets)

Next, locate the driver side bar. The front half of the bar has four bolt holes while the rear half of the bar has three bolt holes, reference figure 3. The top of the bar has a small lip, use the lip to hang the bar on the brackets. This will make the installation process easier and hands-free.

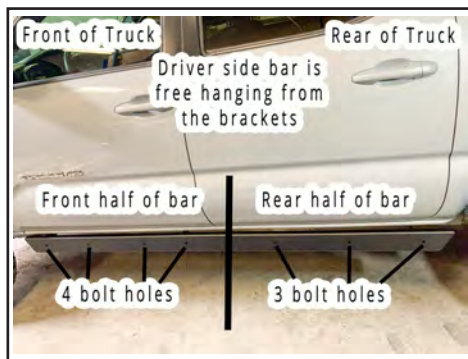

Figure 3.

## ICI STEP INSTALLATION

### Step 4 (Bolt Middle Bracket to Bar)

Start by bolting the middle bracket (100533) to the bar. Use (2 sets) of M8 nylock nuts, M8x35mm hex countersunk bolts, M8 flat washers, and M8 finish washers. Use a 13mm wrench and the provided Allen wrench. Do not fully tighten until all brackets and steps have been attached.



Figure 4.

### Step 5 (Bolt Bar to Front Bracket and Rear Bracket)

Next, bolt the bar to the front bracket (100532). Do not fully tighten yet. Use (2 sets) of M8 nylock nuts, M8x35mm hex countersunk bolts, M8 flat washers, and M8 finish washers. Use a 13mm wrench and the provided Allen wrench. Repeat the steps above for the rear bracket (100533) See the diagram on page 3 for reference.

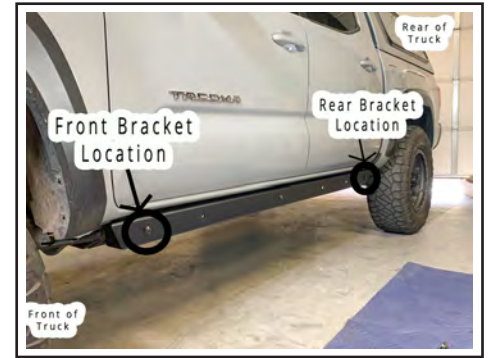

Figure 5.

### Step 6 (Bolt Front and Rear Hoop Steps to bar)

After the brackets have been attached to the bar, bolt the front and rear hoop step to the bar. For each hoop step, use (2 sets) of M8 nylock nuts, M8x35mm hex countersunk bolts, M8 flat washers, and M8 finish washers. Use a 13mm wrench and the provided Allen wrench. Leave loosely fitted for now.

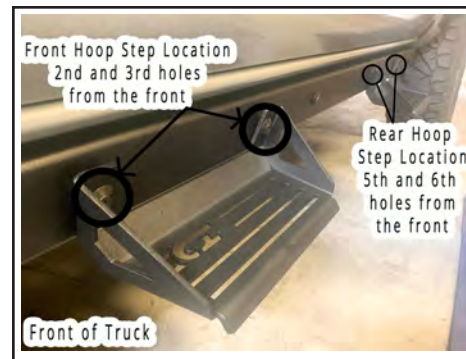

Figure 6.



## ICI STEP INSTALLATION

### STEP 7 (Tighten Brackets to Truck)

Make sure all 3 brackets are loosely fit to the vehicle and bar. Using a 13mm socket, fully tighten the front bracket to the vehicle. Make sure the bracket is flush with the mounting surface. Repeat on the middle and rear bracket checking the bracket alignment as needed. Leave bar loose for now.

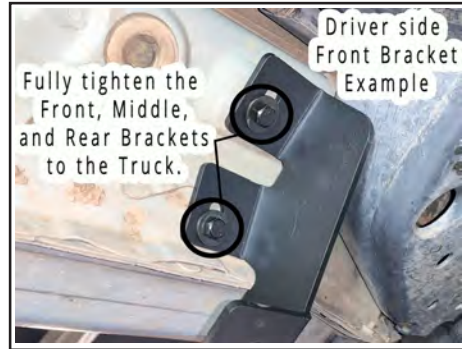

Figure 7.

### STEP 8 (Tighten Brackets to the Bar)

Once the 3 brackets are fully tightened to the truck, adjust the bar from front to back and tighten the bar to the brackets with a 13mm socket and provided Allen wrench. Make sure the bar is flush with the front and bottom face of the brackets as you are tightening them. Then, tighten the Hoop Steps to the bar.



Figure 8.

### STEP 9 (Finish)

Check all hardware and make sure they are fully tightened. Reference diagram on page 3 for hardware locations. Repeat Steps 1-9 for the Passenger Side.



Figure 9.

**\*PRO TIP:** When tightening the Finish Washers, hold the Allen Key tight so the Bolt does not spin. Then, tighten the Nut on the backside. This will prevent the Bolt and Finish Washer from spinning and scratching the Bar.

## TAG ICI ON SOCIAL MEDIA

**AMAZING!**

Drop us a Review!

You have successfully completed the installation of your new Alumilite steps. Time to flex on your friends through Social Media! Don't forget to Tag us!



[www.facebook.com/InnovativeCreationsInd](https://www.facebook.com/InnovativeCreationsInd)



[www.instagram.com/ici\\_usa](https://www.instagram.com/ici_usa)



Hashtags:

#ICIUSA  
#ICAlumilite  
#AlumiliteSteps  
#AlumiliteBumpers