

Instruction Manual P/N:PF5014

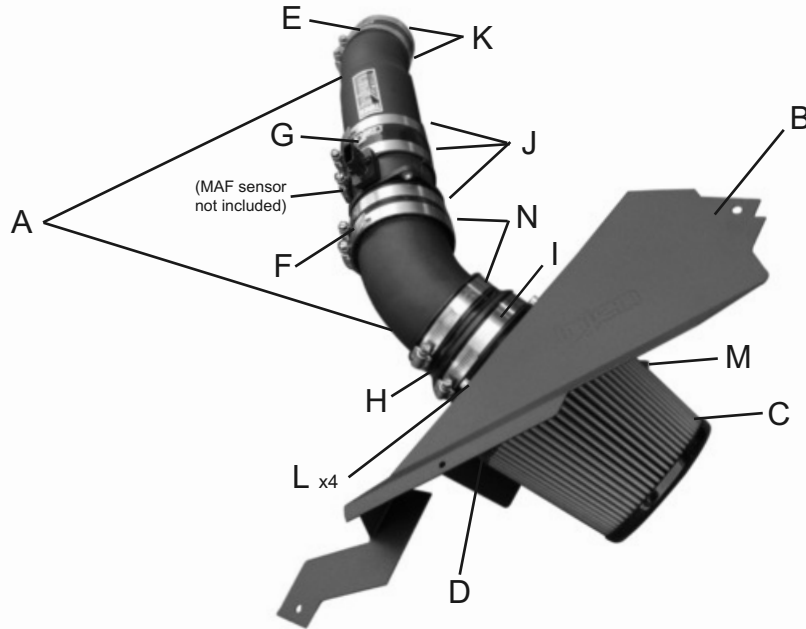

“The World’s First Tuned air Intake System!”
 Factory safe air/fuel ratio’s for Optimum performance
 Injens tuning process covered by three U.S. Patents

Vehicle Application:
 Make: **Jeep**
 Model: **Grand Cherokee ECODiesel**
 Year: **2014-2016**
 Engine: **3.0L V6 Turbo diesel**



Item	QTY.	P/N	Description
A	2	W-PF5014	Intake Tube
B	1	#11136	Heat shield
C	1	#1046	5" Dry air filter
D	1	#6049	4" adaptor
E	1	#3043	2.75 straight hose
F	1	#3140	3.25"x3.5" step hose
G	1	#3045	3.25 straight hose
H	1	#3203	4"x3.50" step hose
I	1	#4006	#64 clamp
J	3	#4004	#48 clamp
K	2	#4003	#40 clamp
L	4	#6056	M6 socket cap screws
M	1	#6014	grommet
N	2	#4005	#56 Clamp

TOOLS REQUIRED

- 10mm Ratchet & Socket
- 8mm nut drive
- Allen key
- Flat Blade Screwdriver
- Phillips Screwdriver

WARNING: FAILURE TO FOLLOW INSTALLATION INSTRUCTIONS AND NOT USING THE PROVIDED HARDWARE MAY DAMAGE THE INTAKE SYSTEM, ENGINE AND COMPONENTS!!!

***Do not attempt to install the intake system while the engine is hot.**

Severe burn could result from touching hot engine components!

Report any defective or missing parts to the authorized Injen dealer you purchased this product from. Before installing any parts of this system, please read the instructions thoroughly. If you have any questions regarding installation, please contact your Injen Technology dealer. Installation DOES require some mechanical skills. A qualified mechanic is always recommended.

A Limited Lifetime Warranty to the original purchaser against defects in material and workmanship on all Injen intake systems excluding the filter element. Any and all warranty coverage is limited to the repair or replacement of the defective part only, at Injen Technology's discretion. The warranty does not cover incidental or consequential damages, nor does it cover the cost of installation or removal of the defective part or its replacement. Proof of purchase is required.

NOTE: This intake kit may not work on vehicles with the following aftermarket modifications.

- Aftermarket Intercooler piping
- Aftermarket intercooler
- Turbo upgrade
- Modified body panels
- Suspension & Chassis modifications

The SuperNano-Web filter media is a dry synthetic media that outperforms the competition. The media itself is a proprietary base blend of synthetics and cellulose. Cellulose fibers are larger than synthetic fibers, and have larger spaces between the fibers, causing contaminants to load in the depth of the media and plug the airflow path. This creates higher restriction levels and less capacity. The synthetic fibers in the SuperNano-Web media are submicron in diameter and have small interior fiber spaces, which result in more contaminants being captured on the surface of the media. This can help keep restriction levels low as the filter loads with dirt and containments



If you look at the picture to the left, you can see the Nano-fiber web on top of our base media. That web, or Super-Nano-Web as we like to call it, helps trap smaller particles and protect your engine.

To Clean your filter:

Carefully remove the filter from the housing. Once removed, wipe down the housing using a clean shop towel, being careful not to knock any dirt and/or debris in the air inlet. Your filters can be cleaned by carefully vacuuming the filter media from the dirty side, or by holding the filter with one hand and carefully blowing the filter media at a 45-degree angle from the clean side using low-pressure shop air (15-20 lbs. psi).

****IT IS IMPORTANT TO NOT USE ANY CLEANERS ON THE SUPERNANO-WEB MEDIA OR APPLY ANY OIL!!!***

NOTE: DISCONNECT BATTERY BEFORE INSTALLATION!!!



1. Stock intake system shown.



2. Lift firmly on the engine cover and temporarily remove from the engine bay for now.

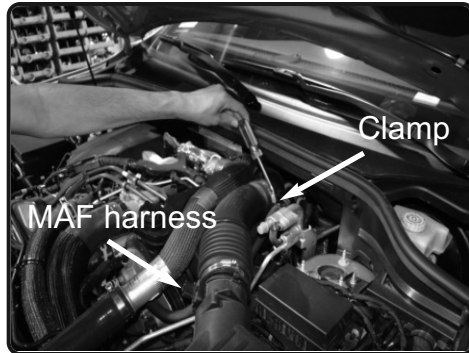

7. Loosen the clamp on the O.E. intake tube and also disconnect the MAF sensor harness



3. Figure A: Remove the O.E. intake tube. **Figure B:** Remove the upper O.E. air box assembly.



4. Firmly lift up on the O.E. lower air box assembly and remove from the engine bay.



5. Unbolt the MAF sensor from the O.E. upper air box assembly. This MAF sensor will be reused in this intake system.



6. Temporarily remove this 10mm bolt from the radiator support. This bolt will secure the Injen heatshield to the radiator support later in [figure 12](#).

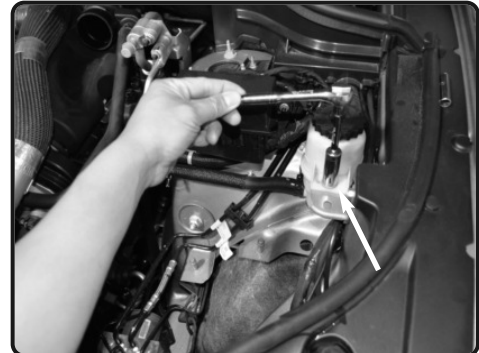

7. Temporarily remove this 13mm bolt from the power steering reservoir. This bolt will also secure the Injen heatshield to the chassis.

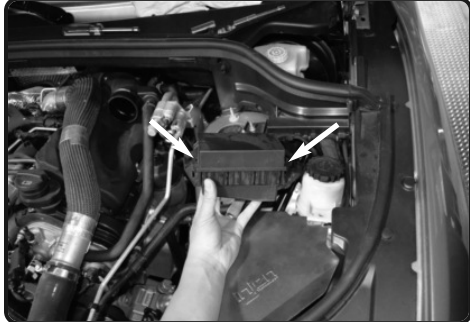

8. Remove the two 10mm nuts to move the fuse/relay box. This will give you more room to install the heat shield.

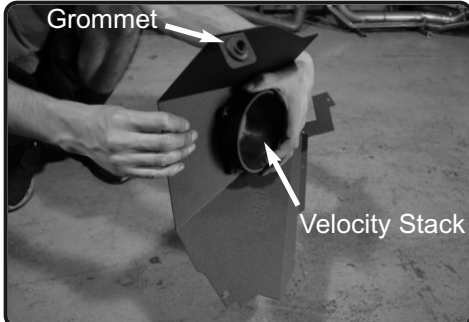

9. Place the velocity stack onto the inside of the heatshield. Also place the supplied grommet onto the mounting tab.

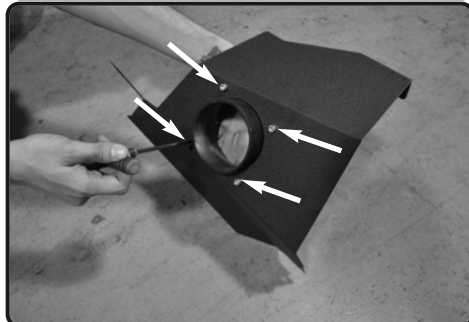

10. Secure the velocity stack to the heatshield with four M6 socket cap screws.



11. Place the filter onto the velocity stack and then secure the clamp.

Instruction Manual P/N:PF5014



12. Lift up the plastic radiator support cover and slide the heatshield bracket under it to its mounting position. The mounting position will be the bolt from [figure 6](#). The heatshield will be secured later.

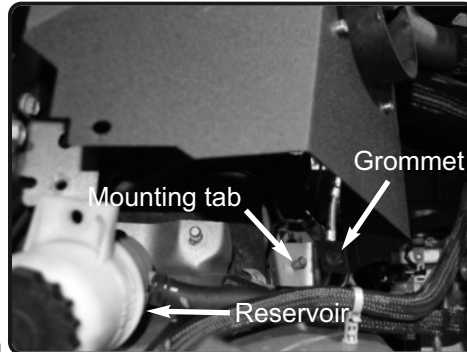

13. Place the grommet on the heatshield from [figure 9](#) onto the O.E. air box mounting tab on the chassis. Use the power steering reservoir in the photo for reference to locate the mounting tab in the photo.



14. Line up the hole on top of the Injen heatshield to the power steering reservoir mounting bracket from [figure 7](#). Then place the reservoir on top of the heatshield and secure it them together with the O.E. bolt.

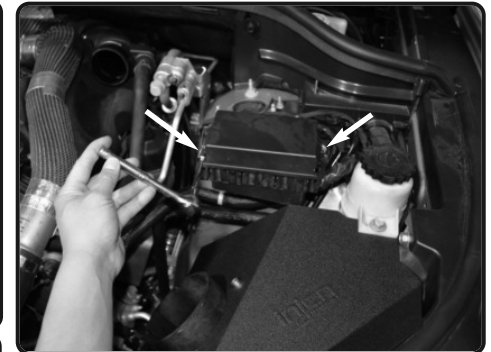

15. Reinstall the fuse/relay box and secure the two 10mm nuts once the heatshield is installed



16. Line up the hole on the bracket of the heatshield to the location where the bolt was removed from [figure 6](#). Reuse the O.E. 10mm bolt to secure the heatshield bracket to the radiator support.



17. Attach the green tree push pin on the trim seal into the hole on the heatshield scoop inlet.



18. Place the 4.00"X3.50" step hose onto the veolcity stack and secure the clamp on the velocity stack side for now.



19. Install the 2.75" straight hose onto the turbo inlet near the firewall. Secure the clamp on the turbo inlet side for now.



20. Place the 3.25" straight hose onto the non-flanged side and the 3.25"X3.50" step hose on the flanged side of the MAF sensor.



21. Place the smaller Injen intake tube with the 2.75" end into the 2.75" hose on the turbo inlet tube from [figure 19](#). Leave the clamp loose for now untill you make your final intake tube adjustment.



22. Place the Injen 3.5" tube into the 3.50" side of the step hose. Leave the clamp loose for now.

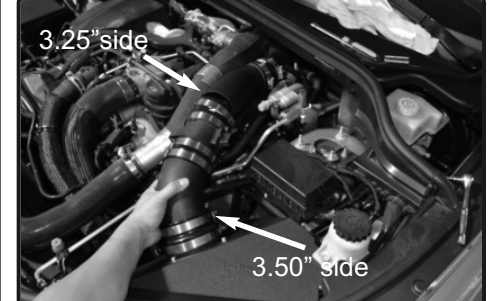

23. Place the 3.50" tube into the 3.5" hose on the velocity stack and the Injen smaller tube into the 3.25" hose on the MAF sensor.

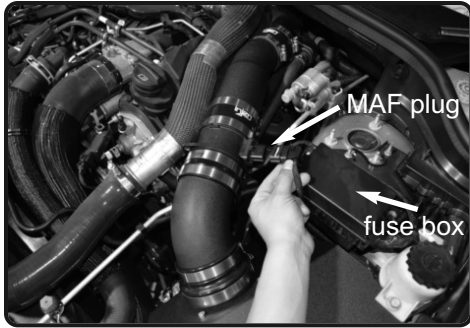

24. Once the intake tubes and hoses are installed, rotate the MAF sensor plug towards the fuse/relay box and then connect the MAF sensor harness.



23. Reinstall the Engine cover and make sure the Injen intake tube clears all parts of the engine cover. Adjust the intake for best fitment before you secure all the clamps.



Congratulations! You have just completed the installation of this intake system. Periodically, check the alignment of the intake, normal wear and tear can cause nuts and bolts to come loose. Note: Check clearance and adjust if needed! Failure to check the alignment and adjust the intake can cause damage that will void the warranty. Injen Technology is not responsible for any damages caused by/from improper installation.

Test Drive:

1. With the transmission in neutral or park and the parking brake engaged, start the engine. Listen for air leaks or odd noises. If air leaks are detected, secure hoses and connections. For any odd noises, inspect entire system for cause and adjust intake as needed. The Injen intake will function identically to the factory system but will be louder and more powerful.
2. Perform a road test. Listen for odd noises or rattles and fix as necessary.
3. If there are no issues, continue to enjoy your added performance from the Injen performance Intake kit.
4. Injen Technology recommends you periodically check clearance and adjust if needed! Failure to check the alignment and adjust the intake can cause damage that will void the warranty. Injen Technology is not responsible for any damages caused by/from improper installation.

1. Upon completion of the installation, reconnect the negative battery terminal before you start the engine.
2. Align the entire intake system for the best possible fit. Once the intake has been properly fitted continue to tighten all nuts, bolts and clamps.
3. Periodically, recheck the alignment of the intake system and make sure there is proper clearance around and along the length of the intake. Failure to follow proper maintenance procedures may cause damage to the intake and will void the warranty.
4. Start the engine and listen carefully for any odd noises, rattles and/or air leaks prior to taking it for a test drive. If any problems arise go back and check the vacuum lines, hoses and clamps that maybe causing leaks or rattles and correct the problem.
5. Check the filter for excessive dirt build up. Clean or replace the filter with an original Injen filter (can be bought on-line at "injenonline.com"). Congratulations! You have just completed the installation of the best intake system sold on the market. Enjoy the added power and performance of your new intake system.