

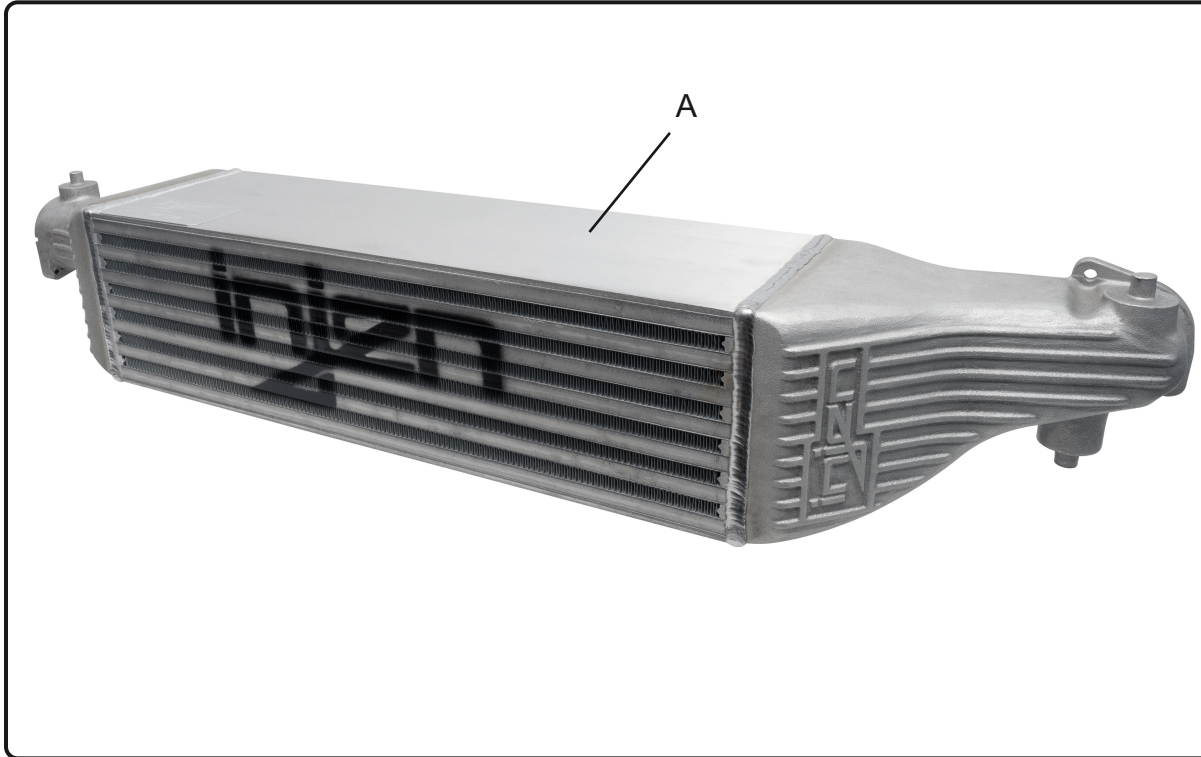

Vehicle application:
 2016-2021 Honda Civic
 2017-2020 Honda Civic SI
 Engine: 1.5L 4-cyl. Turbo



Item	Qty	P/N	Discription
A	1	#FM1573i	Intercooler

- TOOLS REQUIRED**
- Pliers
 - Ratchet
 - 13mm Socket
 - 10mm Socket
 - 8mm nut drive
 - Allen key
 - Flat Blade Screwdriver
 - Phillips Screwdriver
 - 5.5mm nut driver
 - 7mm nut driver

WARNING: FAILURE TO FOLLOW INSTALLATION INSTRUCTIONS AND NOT USING THE PROVIDED HARDWARE MAY DAMAGE THE INTERCOOLER SYSTEM, ENGINE AND COMPONENTS!!!
***Do not attempt to install the intercooler system while the engine is hot.**
 Severe burn could result from touching hot engine components!

Report any defective or missing parts to the authorized Injen dealer you purchased this product from. Before installing any parts of this system, please read the instructions thoroughly. If you have any questions regarding installation, please contact your Injen Technology dealer. Installation DOES require some mechanical skills. A qualified mechanic is always recommended.

Instruction Manual P/N:FM1573I



1. Remove the plastic rivet clips to remove the radiator support cover.



2. Remove the plastic cover from vehicle.



7. Carefully raise the vehicle up and unscrew the 2 screws on both sides of bumper.

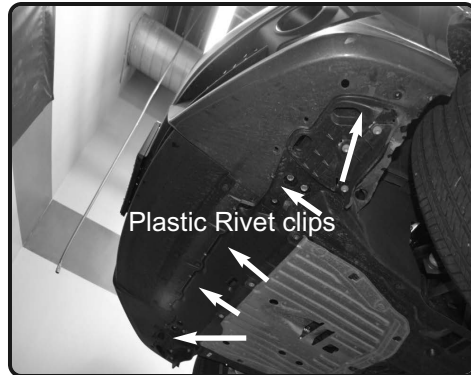

3. Remove the screws and plastic rivet clips on bottom of bumper using flat head screwdriver, t30 torx, and 10mm socket.

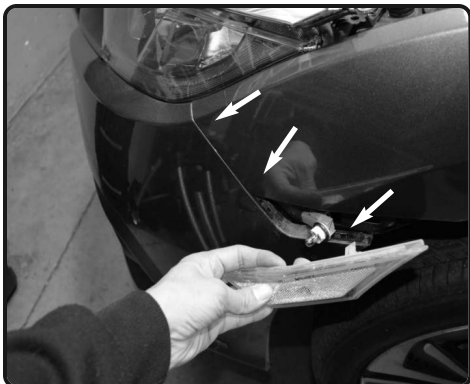

4. With flat head screwdriver carefully push clip back, and remove the side indicator. Pull panel of bumper back.

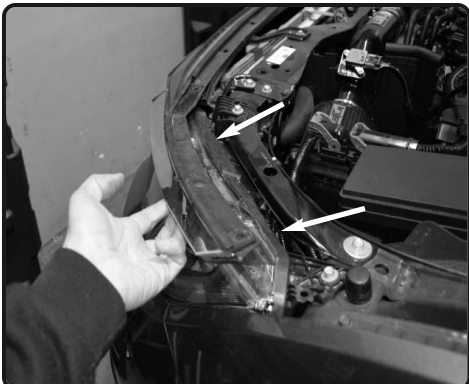

5. With flat head screwdriver, locate the push clip and pull back the top of the headlight trim. **Carefull not pull to hard.**

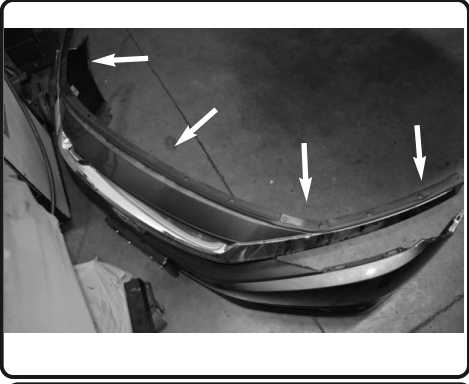

6. Now pull back the bumper and remove.

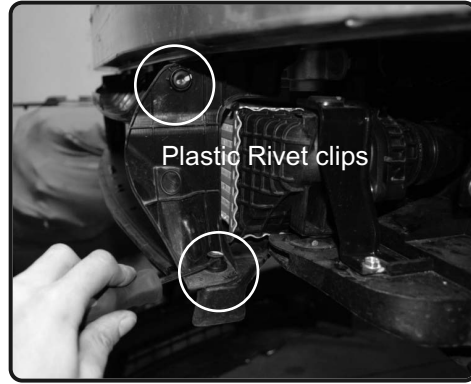

7. Now loosen the plastic rivet clips holding in the intercooler plastic shroud on driver side.

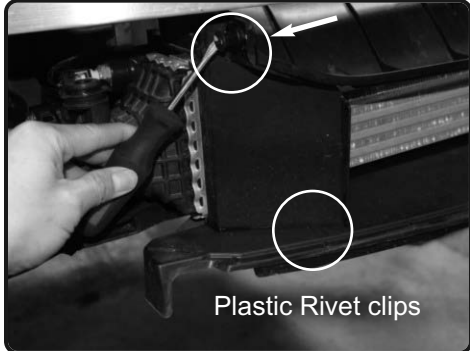

8. Loosen the plastic rivet clips holding in the intercooler plastic shroud on passenger side.

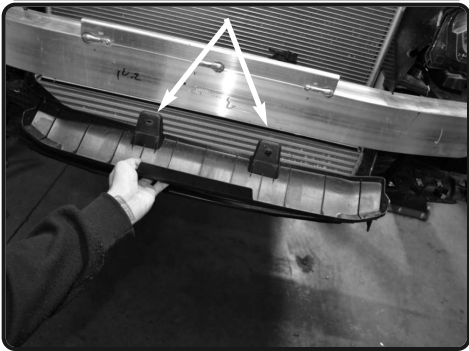

9. Remove the top part of the plastic shroud. This will not be used in the vehicle with the injen intercooler.

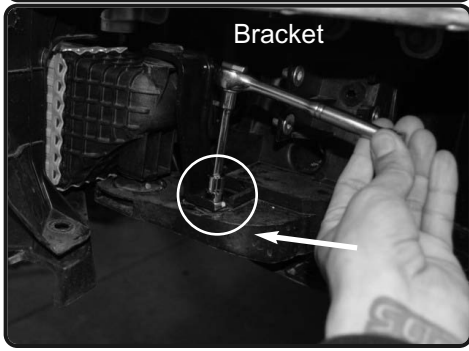

10. Loosen the intercooler bracket using 10mm socket or wrench.

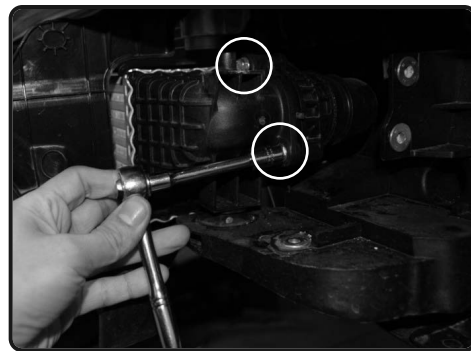

11. Loosen the 2 screws holding in the intercooler to the intercooler pipe. Save bracket and screws for later use.

Instruction Manual P/N:FM1573I

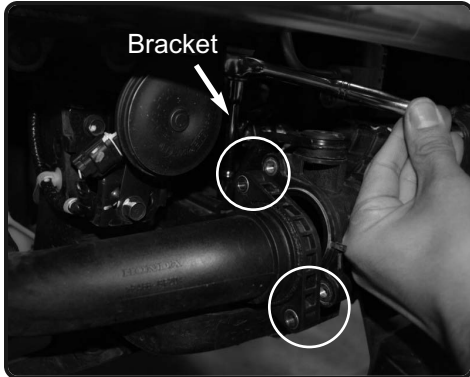

12. On the passenger side loosen the intercooler bracket using 10mm socket or wrench. Loosen the 2 screws holding in the intercooler to the intercooler pipe. Save bracket and screws for later use.

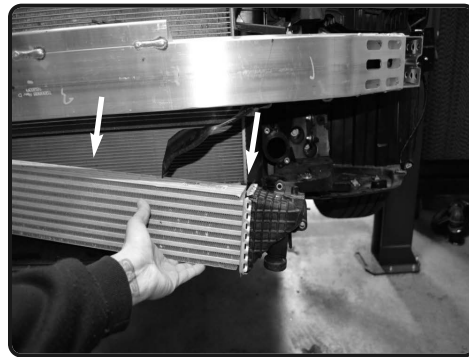

13. Now carefully remove the intercooler out of the vehicle.

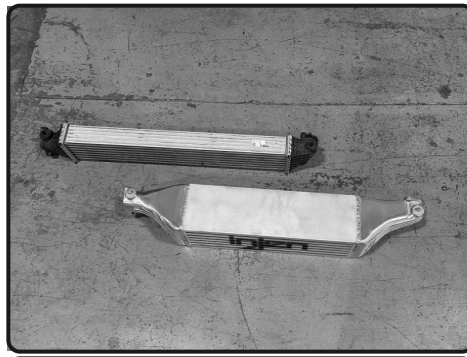

14. Above image is the comparison of the injen intercooler and OEM intercooler.

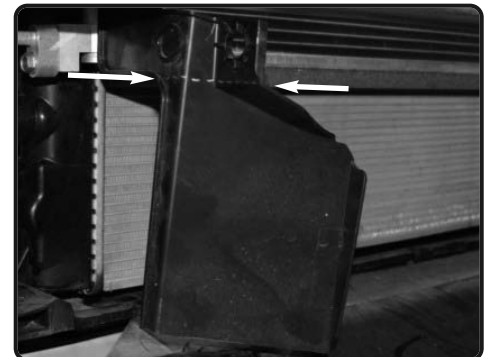

15. Mark the passenger side plastic shroud with a marker like above image.

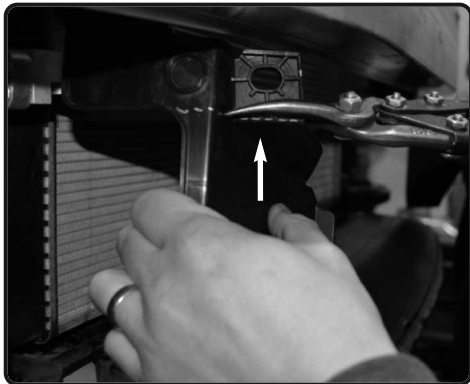

16. Cut plastic like above image.

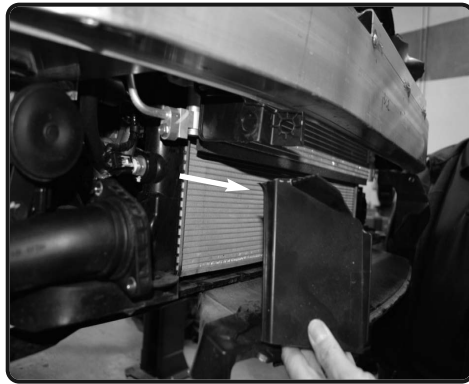

17. Remove plastic piece and discard.

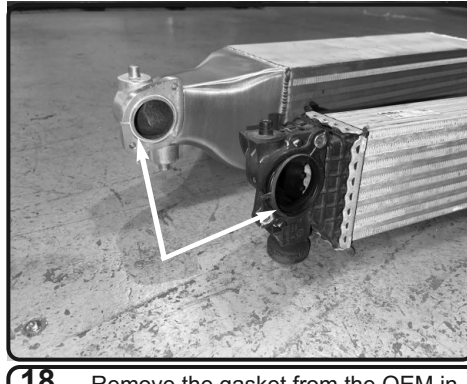

18. Remove the gasket from the OEM intercooler. Install to the injen intercooler on both sides. **Note:make sure these are installed on both sides before installation.**



19. Remove the grommet from the OEM intercooler.



20. Install the grommet to the injen intercooler fitting.



21. Now install injen intercooler.

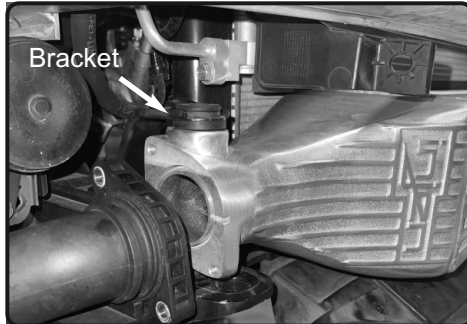

22. Install the bracket to the passenger side. Secure and tighten.

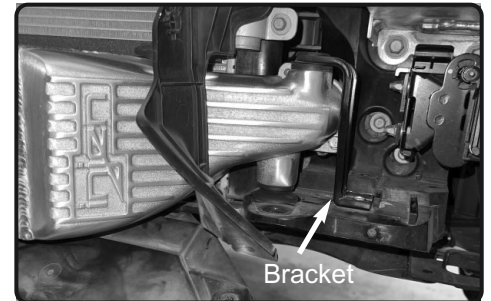

23. Install the bracket to the driver side. Secure and tighten.

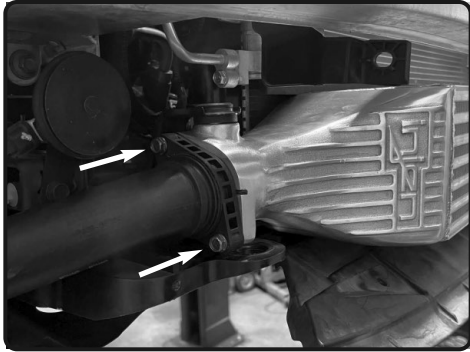

20. Reinstall the OEM screws and secure passenger intercooler pipe to the Injen intercooler.

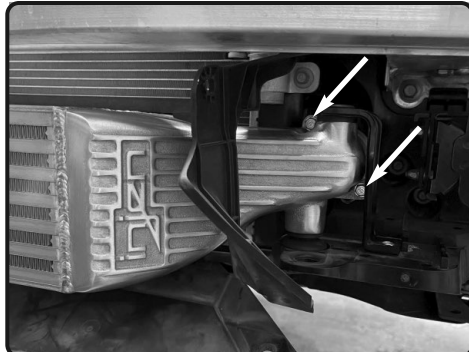

21. Tighten the Driver side intercooler using 10mm socket or wrench.



22. Your Injen intercooler installation is now complete. Make your final adjustment and make sure all your nuts, bolts and clamps are secure. Reinstall the rest of the bumper components in reverse order.



Congratulations! You have just completed the installation of the Injen intercooler system. Periodically, check the alignment of the intercooler, normal wear and tear can cause nuts and bolts to come loose. **Note: Check clearance and adjust if needed! Failure to check the alignment and adjust the intercooler can cause damage that will void the warranty. Injen Technology is not responsible for any damages caused by/from improper installation.**

Test Drive:

1. With the transmission in neutral or park and the parking brake engaged, start the engine. Listen for air leaks or odd noises. If air leaks are detected, secure hoses and connections. For any odd noises, inspect entire system for cause and adjust intercooler as needed. The Injen intercooler will function identically to the factory system but will be more powerful.
2. Perform a road test. Listen for odd noises or rattles and fix as necessary.
3. If there are no issues, continue to enjoy your added performance from the Injen performance intercooler kit.
4. Injen Technology recommends you periodically check clearance and adjust if needed! Failure to check the alignment and adjust their intercooler can cause damage that will void the warranty. Injen Technology is not responsible for any damages caused by/from improper installation.

1. Upon completion of the installation, reconnect the negative battery terminal before you start the engine.
2. Align the entire intercooler system for the best possible fit. Once the intercooler has been properly fitted continue to tighten all nuts, bolts and clamps.
3. Periodically, recheck the alignment of the intercooler system and make sure there is proper clearance Failure to follow proper maintenance procedures may cause damage to the intercooler and will void the warranty.
4. Start the engine and listen carefully for any odd noises, rattles and/or air leaks prior to taking it for a test drive. If any problems arise go back and check the vacuum lines, hoses and clamps that maybe causing leaks or rattles and correct the problem.