

# Instruction Manual P/N:EVO15070



## CAUTION:

Please use caution if using Injen's snorkel to submerge the vehicle under water. The consumer is responsible for completely sealing the Injen air box with a proper silicone to prevent the engine from ingesting water and hydro locking the engine. Injen Technology is not liable for any misuse or improper installation on this snorkel

**CAUTION:** Injen Technology **HIGHLY RECOMMENDS THIS INTAKE SNORKEL BE INSTALLED BY A TRAINED PROFESSIONAL.** This kit does require cutting, drilling and grinding of the factory hood. Improper installation could result in damage to body panels and components.

## EXPLODED VIEW

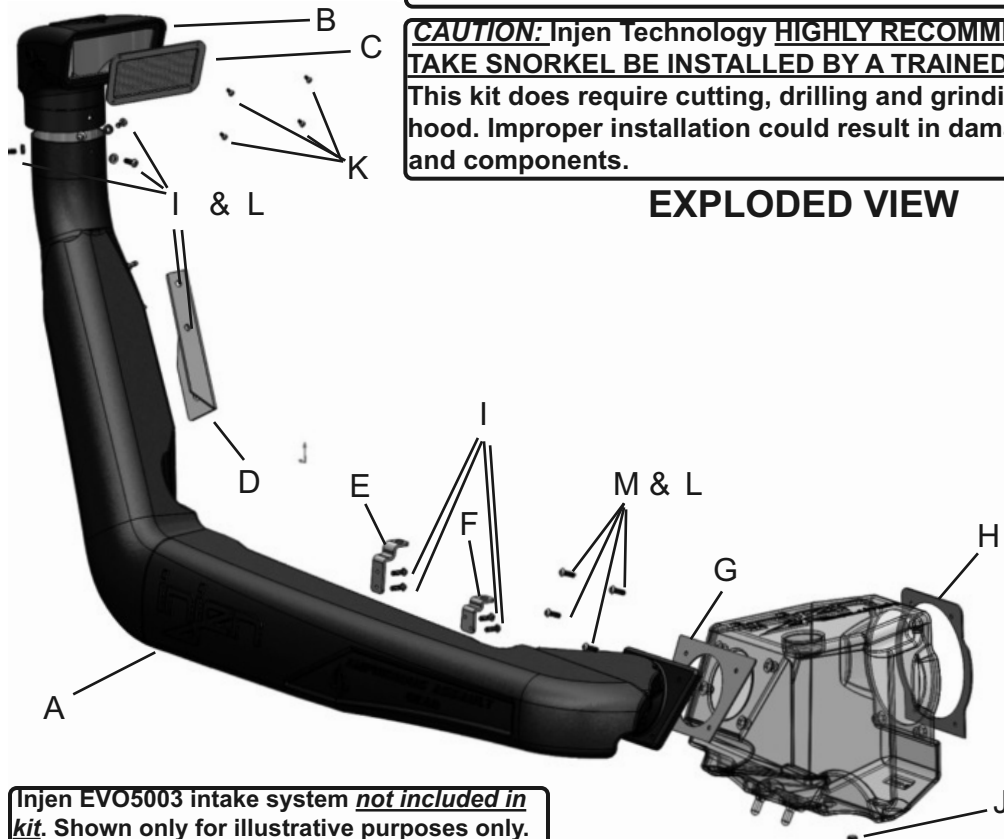

Injen EVO5003 intake system *not included in kit*. Shown only for illustrative purposes only.

**WARNING:** FAILURE TO FOLLOW INSTALLATION INSTRUCTIONS AND NOT USING THE PROVIDED HARDWARE MAY DAMAGE THE INTAKE SYSTEM, ENGINE AND COMPONENTS!!!

**\*Do not attempt to install the intake system while the engine is hot.**

Severe burn could result from touching hot engine components!

Report any defective or missing parts to the authorized Injen dealer you purchased this product from. Before installing any parts of this system, please read the instructions thoroughly. If you have any questions regarding installation, please contact your Injen Technology dealer. Installation DOES require some mechanical skills. A qualified mechanic is always recommended.

A Limited Lifetime Warranty to the original purchaser against defects in material and workmanship on all Injen intake systems excluding the filter element. Any and all warranty coverage is limited to the repair or replacement of the defective part only, at Injen Technology's discretion. The warranty does not cover incidental or consequential damages, nor does it cover the cost of installation or removal of the defective part or its replacement. Proof of purchase is required.

## Vehicle Application:

Make: **Jeep**

Model: **Wrangler (JK)**

Year: **2007-2018**

Engine: **V6-3.8L/3.6L**

## NOTE:

This optional Injen Intake snorkel is an accessory to Injen Part# EVO5003. The Injen intake part# EVO5003 is not included in this kit. It is available separately. *This snorkel will only work with Jeep Wrangler JK Injen intake system part # EVO5003.* Injen does not recommend modifying or altering this snorkel to make it fit other applications.

Item	QTY.	P/N	Description
A	1	#15070	Snorkel
B	1	#15075	Ram scoop
C	1	#11118	Stainless mesh screen
D	1	#20119	Bracket A
E	1	#20120	Bracket B
F	1	#20121	Bracket C
G	1	#6102	Snorkel gasket
H	1	#6103	Plenum gasket
I	9	#6083	M6 socket cap allen screws
J	1	#8050	3/8" NPT plug
K	4	#6047	M4X10mm Bolts
L	7	#8047	Washer seal
M	4	#6096	M6x30 bolt
N	1	#6101	Vinyl trim @ 16" Length

## TOOLS REQUIRED

- 8mm nut drive
- Allen key
- Flat Blade Screwdriver
- Phillips Screwdriver
- 1.75" Hole saw
- Drill
- Air saw

**NOTE:** This intake kit may not work on vehicles with the following aftermarket modifications.

- Some aftermarket Light bars
- Some aftermarket fenders
- Aftermarket hoods

**Injen designed this snorkel on a stock jeep and the installation of this snorkel may cause interference with aftermarket parts.**

**Note:**

**The C.A.R.B. Exempt sticker must be attached under the hood in a manner that is easily viewed by an emissions inspector.**

The SuperNano-Web filter media is a dry synthetic media that outperforms the competition. The media itself is a proprietary base blend of synthetics and cellulose. Cellulose fibers are larger than synthetic fibers, and have larger spaces between the fibers, causing contaminants to load in the depth of the media and plug the airflow path. This creates higher restriction levels and less capacity. The synthetic fibers in the SuperNano-Web media are submicron in diameter and have small interior fiber spaces, which result in more contaminants being captured on the surface of the media. This can help keep restriction levels low as the filter loads with dirt and containments



The image block contains the Injen Technology logo, a large image of the SuperNano-Web filter media, and two smaller images comparing existing media without the technology to the superior Injen SuperNano-Web Technology. A spider icon is also present, symbolizing the technology's ability to trap small particles.

**injen**<sup>®</sup>  
TECHNOLOGY

Existing media without Injen SuperNano-Web Technology

Superior Injen SuperNano-Web Technology

A New Generation of Filters Designed to perform and filter like no other

**INJEN SuperNano-Web Technology**

If you look at the picture to the left, you can see the Nano-fiber web on top of our base media. That web, or SuperNano-Web as we like to call it, helps trap smaller particles and protect your engine.

**To Clean your filter:**

Carefully remove the filter from the housing. Once removed, wipe down the housing using a clean shop towel, being careful not to knock any dirt and/or debris in the air inlet. Your filters can be cleaned by carefully vacuuming the filter media from the dirty side, or by holding the filter with one hand and carefully blowing the filter media at a 45-degree angle from the clean side using low-pressure shop air (15-20 lbs. psi).

***\*IT IS IMPORTANT TO NOT USE ANY CLEANERS ON THE SUPERNANO-WEB MEDIA OR APPLY ANY OIL!!!***

**NOTE: DISCONNECT BATTERY BEFORE INSTALLATION!!!**

# Instruction Manual P/N:EVO15070

Design Patent Pending 59/523,710



1. Injen EVO5003 intake shown.

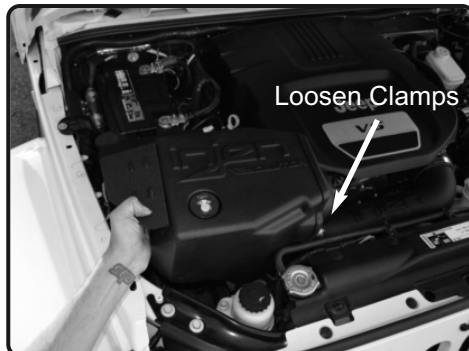

2. Loosen the clamp on the 4.0" hump hose and remove the Injen intake box from the engine bay.

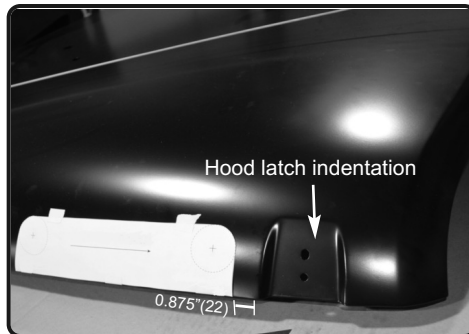

3. Remove the hood from the vehicle. Measure 0.875" (22mm) from the hood latch indentation outer tangent point. Tape the cut template onto the hood. Figure 4 will have a close up of the measuring point

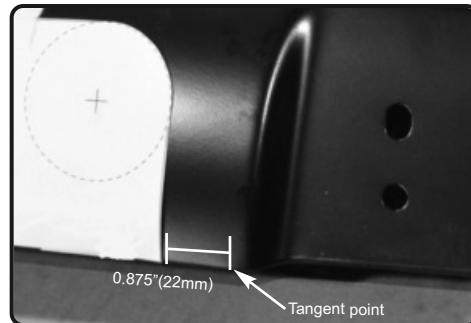

4. Locate the hood latch indentation outer tangent point and measure 0.875" left of tangent to locate supplied cutting template.

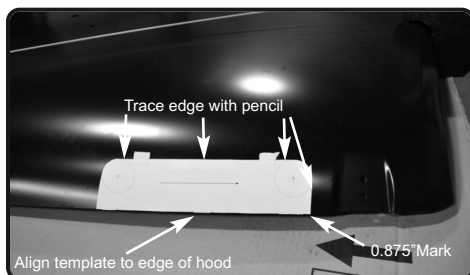

5. Now tape the cutting template to the hood from the 0.875" mark from figure 9 and make sure you line up the bottom of the cutting template to the edge of the hood. Use a pencil and trace the edge of the template for a cutting guide for the next step.



6. Using the crosshairs on the cutting template as a guide, use a 1 3/4" hole saw and drill out the two holes on the template. Make sure you drill past the second layer of the hood. **Please use caution!!!**

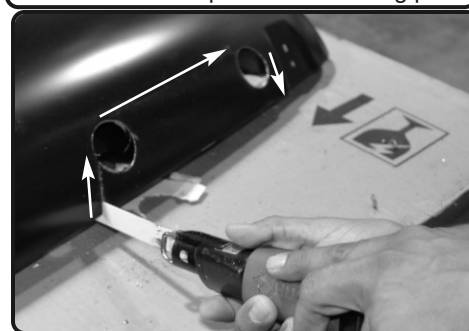

7. The line drawn from the template in figure 10 will be a guide to cut using an air saw to cut a straight line. **Please use caution and cut slow!!!**

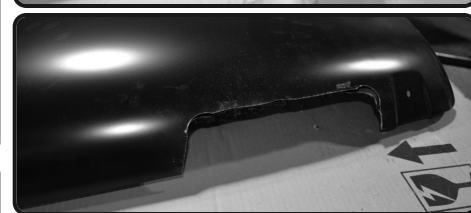

8. This is what it will look like once you have make your cuts with the air saw



9. Use a flat grinder to straighten the edges and clean up all the metal burrs. Slowly grind back on the open. Only grind what you need for additional clearance. **Please use caution and have proper safety equipment like goggles and air respirator!!!**



10. Place the 16" vinyl trim onto the edge of the cut out. Re-install your hood and the snorkel is ready for installation



11. Use an allen wrench and remove the Air Box Shield Air Director from the Injen air box. This shield will no longer be used. The snorkel will now be installed.

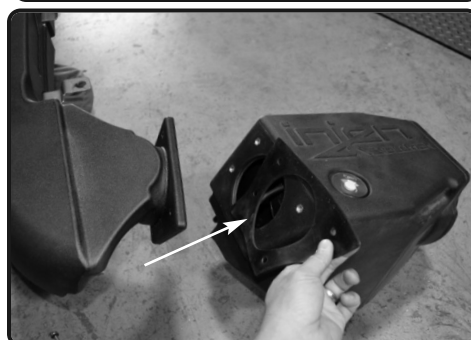

12. Place the supplied gasket in between the Injen air box and the snorkel

# Instruction Manual P/N:EVO15070

Design Patent Pending

59/523,710

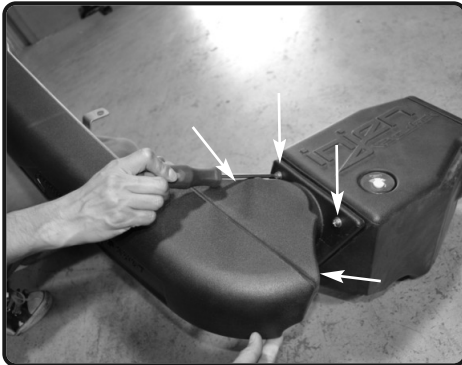

**13.** Place 4-M6X30 Philip screws to secure the snorkel to the Injen air box.

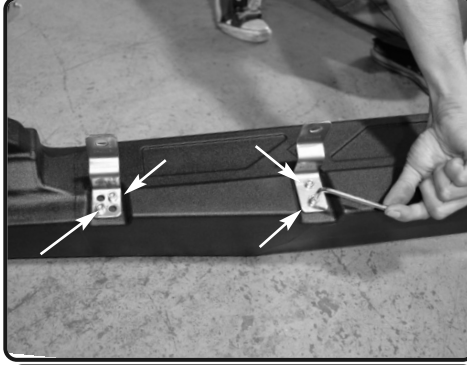

**14.** Mount the B & C bracket onto the inside of the Snorkel and secure them with 4-M6 allen bolts. The brackets will only go in their specific locations.



**15.** Install the A-bracket onto the side of the snorkel and secure it with 2-M6 allen bolts



**16.** Remove the two upper torx bolts on the passenger side window pillar. (Light bar bracket shown in photo) not included



**17.** Remove the 2-10mm bolts on the fender.



**18.** Re-install the Injen air box with the Injen snorkel attached to it.

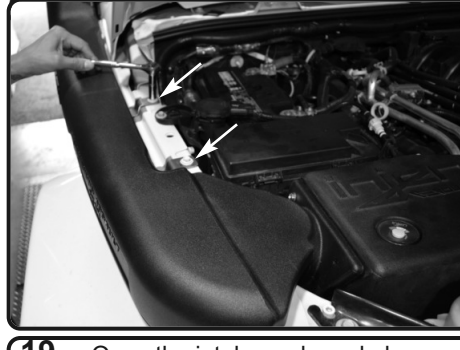

**19.** Once the intake and snorkel are re-installed, re-use the two factory 10mm bolts removed from figure 16 and secure the bracket on the snorkel to the fender.



**20.** Re-use the 2 factory torx bolts and secure the A-bracket to the window pillar



**21.** Install 3- M6 allen bolts and washers to secure the snorkel scoop to the snorkel.



**22.** Use 4-M4 bolts to secure the mesh screen to the snorkel scoop





Congratulations! You have just completed the installation of this intake system. Periodically, check the alignment of the intake, normal wear and tear can cause nuts and bolts to come loose. **Note: Check clearance and adjust if needed! Failure to check the alignment and adjust the intake can cause damage that will void the warranty. Injen Technology is not responsible for any damages caused by/from improper installation.**



### Test Drive:

1. With the transmission in neutral or park and the parking brake engaged, start the engine. Listen for air leaks or odd noises. If air leaks are detected, secure hoses and connections. For any odd noises, inspect entire system for cause and adjust intake as needed. The Injen intake will function identically to the factory system but will be louder and more powerful.
2. Perform a road test. Listen for odd noises or rattles and fix as necessary.
3. If there are no issues, continue to enjoy your added performance from the Injen performance Intake kit.
4. Injen Technology recommends you periodically check clearance and adjust if needed! Failure to check the alignment and adjust the intake can cause damage that will void the warranty. Injen Technology is not responsible for any damages caused by/from improper installation.

1. Upon completion of the installation, reconnect the negative battery terminal before you start the engine.
2. Align the entire intake system for the best possible fit. Once the intake has been properly fitted continue to tighten all nuts, bolts and clamps.
3. Periodically, recheck the alignment of the intake system and make sure there is proper clearance around and along the length of the intake. Failure to follow proper maintenance procedures may cause damage to the intake and will void the warranty.
4. Start the engine and listen carefully for any odd noises, rattles and/or air leaks prior to taking it for a test drive. If any problems arise go back and check the vacuum lines, hoses and clamps that maybe causing leaks or rattles and correct the problem.
5. Check the filter for excessive dirt build up. Clean or replace the filter with an original Injen filter (can be bought on-line at "injenonline.com"). Congratulations! You have just completed the installation of the best intake system sold on the market. Enjoy the added power and performance of your new intake system.

This page left intentionally blank

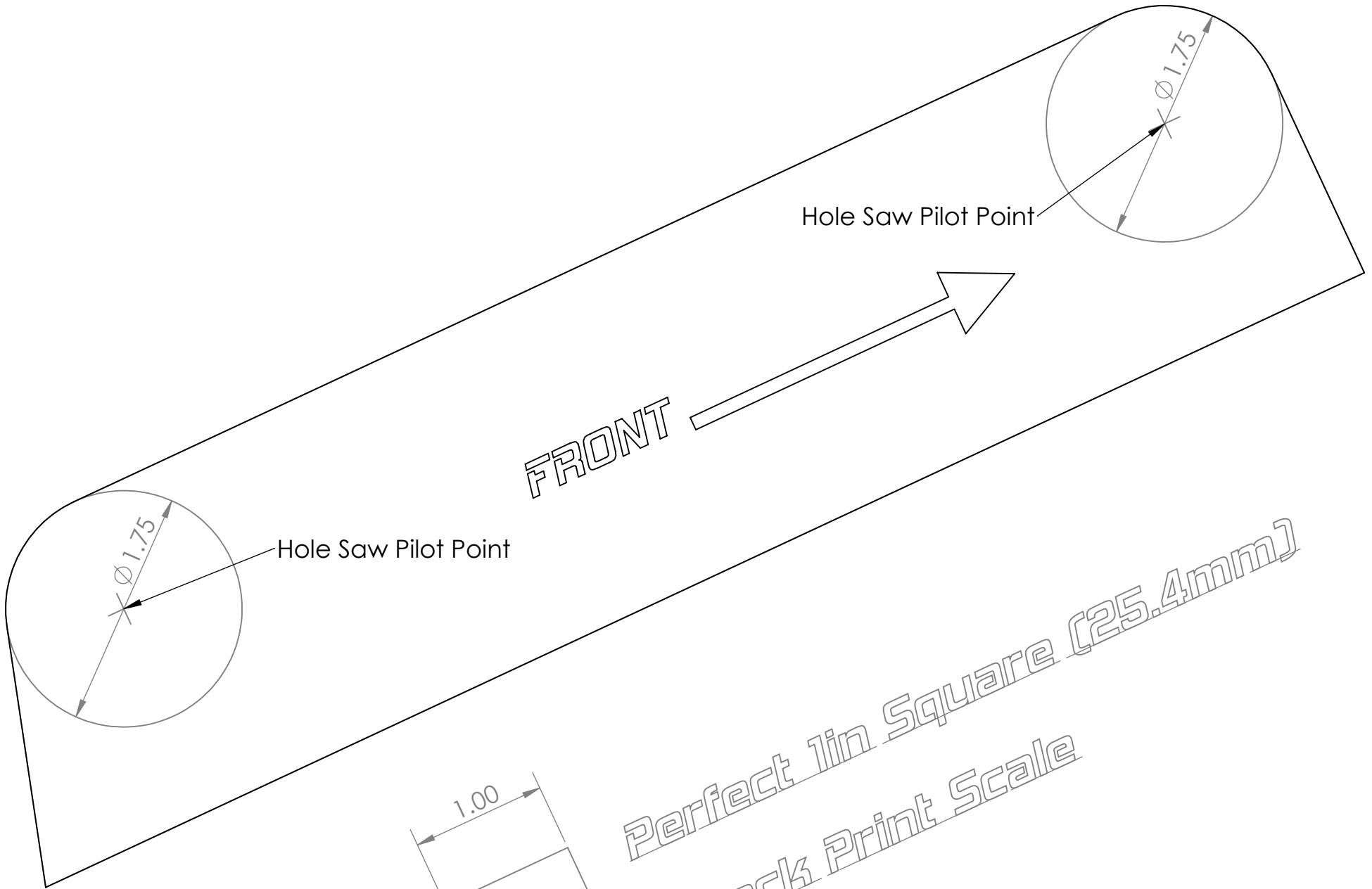

FRONT

Hole Saw Pilot Point

Hole Saw Pilot Point

$\varnothing 1.75$

$\varnothing 1.75$

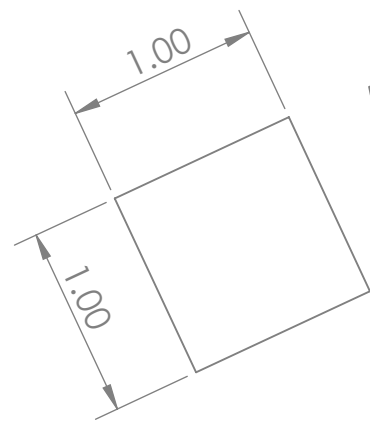

Perfect 1in Square (25.4mm)  
Check Print Scale