



# INSTALLATION INSTRUCTIONS TRANSMISSION COOLER PART # 13401-13403

Please read these instructions completely before starting the installation.

## KIT CONTENTS

QTY.	DESCRIPTION	QTY.	DESCRIPTION
1	Transmission Cooler	2	-6AN x 7/8"-14 Male Adapter
1	11/32" X 4' Hose	4	Mounting Rods
4	Hose Clamps	4	Mounting Clips
1	Insta-dapt Adapter	4	1x1 Foam Pads
2	-6AN x 3/8" Barb		

## TOOLS NEEDED

Standard Screw Driver 7/8" Open End Wrench  
or 5/16" Nut Driver 1 1/8" Open End Wrench  
Dyke Pliers  
Razor Knife  
5/8" Open End Wrench

## IMPORTANT

This kit includes an Insta-dapt Adapter fitting for adapting the cooler line to the radiator. (See Diagram #1)

The Insta-dapt fitting has a 1/2"-20 Male/Female thread and fits most vehicles with 5/16" transmission cooler lines.

For vehicles that are not compatible with the Insta-dapt Adapter, please reference Radiator Adapter Fitting Guide included.

## PRE-INSTALLATION

1. Identify the two -6AN x 7/8" Male Adapters.
  2. Install the fittings onto the cooler with the o-ring side toward the cooler.
- Note:** Thread sealant is not necessary on o-ring fittings.
3. Using a 1 1/8" Open End Wrench, tighten fittings.
  4. Install -6AN x 3/8" Barb Fittings onto the cooler and tighten.
  5. Identify the 11/32" X 4' Hose and Hose Clamps.
  6. Slide one hose clamp on each end of the supplied Hose.
  7. Using a dab of oil, lubricate each end of the hose and install hose onto the cooler inlets forming a loop.
  8. Secure in place using the Hose Clamps.

## COOLER LOCATION

When selecting the best location for your vehicle, always consider a location that will deliver the maximum airflow. (See Diagram #2)

The Transmission Cooler can be mounted in multiple locations on your vehicle. Reference Diagram # 2 for possible cooler positions. #1 is the ideal location, #2 is second best and #4 being the last choice.

**Note:** The Cooler core will flow in either direction, there is no specified inlet or outlet port.

## Diagram #1



## Diagram #2

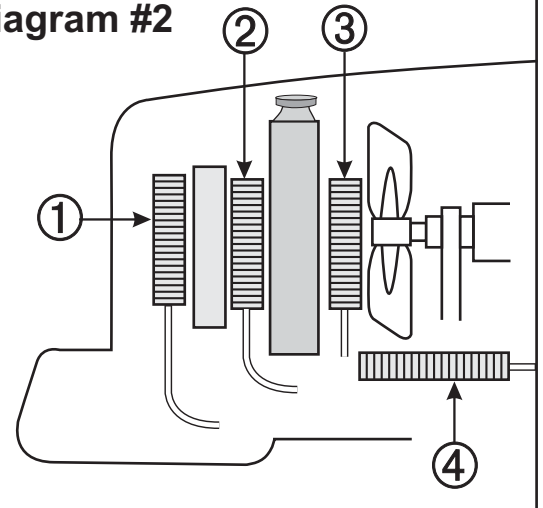

## COOLER INSTALLATION

### Mounting

(See Diagram #3)

1. Identify the 4 Mounting Rods, 4 Mounting Clips and 4 1x1 Foam Pads.
2. One by one, Install the 4 Mounting Rods thru the Transmission Cooler.
3. Take the 1x1 Foam Pads supplied, peel off the paper lining & slide them onto the Mounting Rods, sticking them against the Transmission Cooler.
4. Take the Cooler Assembly with attached looped hose and hold in the desired location.
5. Install the 4 Mounting Rods thru the Radiator/Condenser core.

**Warning:** Do not use excessive force when pushing the Mounting Rods through the Radiator/Condenser. Excessive force could cause damage to the fins and possibly puncture a tube.

6. Take the Mounting Clips supplied, making sure they are in the correct direction (Derales writing out) install onto the Mounting Rods and cinch them until the 1x1 Foam Pads are slightly compressed.
7. Cut off any excess Mounting Rods.

(Continues on Page 2)

## Diagram #3

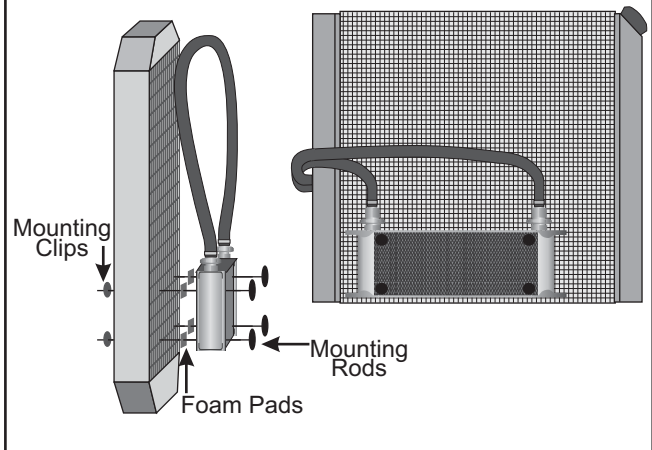

## INSTALLATION CONTINUED

### Locate Transmission Lines

1. Find the two transmission oil lines that run from the transmission to the radiator, usually steel lines connected to the bottom radiator tank or on a cross-flow radiator the passenger side tank.
2. We recommend using the cooler in series with the factory radiator cooler. To do this you need to determine the return line to the transmission. Warm up vehicle & feel the trans lines, the colder of the two lines will be the return line.

### Hose Connections

1. Disconnect the return transmission cooler line from the radiator.
2. Take the supplied Insta-dapt Adapter fitting and install onto radiator using the appropriate Male or Female end.

**Note:** The Insta-dapt fitting has a 1/2"-20 Thread and fits most vehicles with 5/16" transmission cooler lines. For vehicles that are not compatible with the Insta-dapt Adapter, please reference the Radiator Adapter Fitting Guide included or go to [www.derales.com](http://www.derales.com) for alternative radiator fitting options.

3. Carefully route the looped hose now attached to the cooler to the Insta-dapt Adapter now connected to the radiator. (See diagram #4 & 5)
4. Using the supplied Hose Clamp, cut hose and attach to the Insta-dapt Adapter.
5. Route the remaining hose to the disconnected transmission line and cut hose to length.
6. Using the supplied Hose Clamp, attach and tighten.

**Warning:** When routing hoses, be sure to keep all hoses away from sharp edges, moving parts and hot engine components. Hoses should be routed carefully and should not be bent in less than a 3" radius.

**Important:** A kinked hose will restrict flow and could cause transmission failure.

### Diagram #4

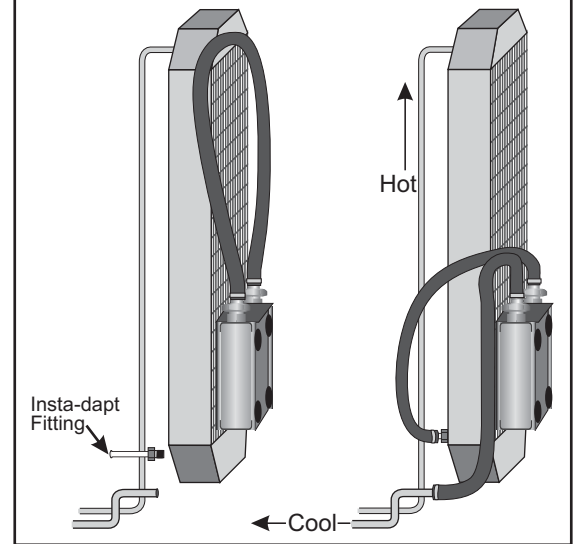

### Diagram #5

#### Secondary Cooling (Preferred Method)

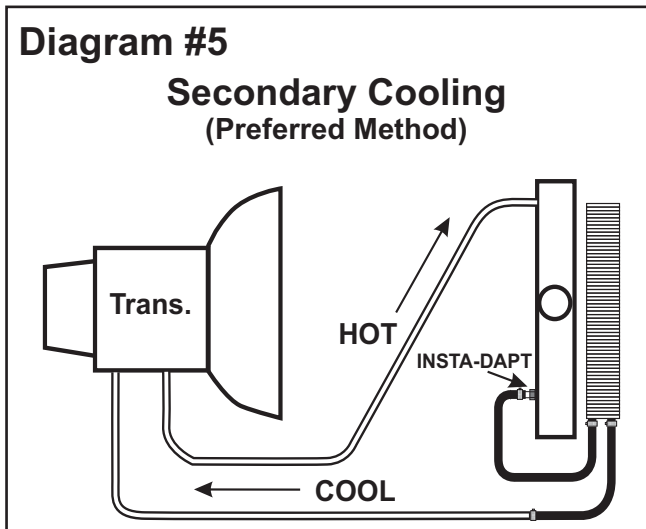

### Diagram #6

#### Optional Installation Method (Detailed Instructions Not Provided)

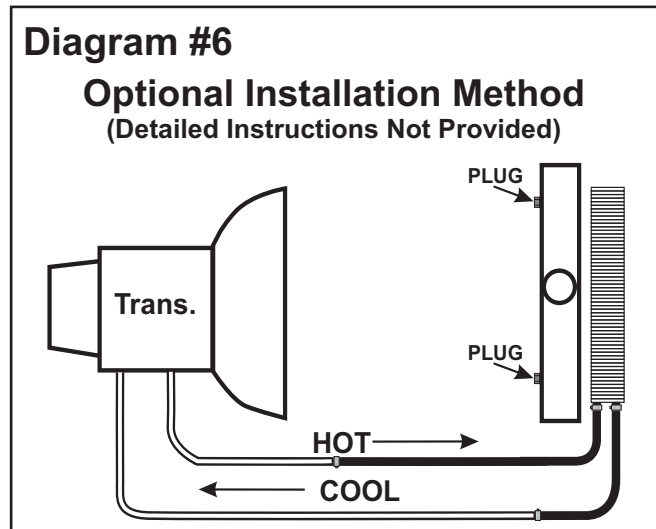

## SYSTEM CHECK

1. Start the vehicle and quickly check all connections for leaks.
2. With the vehicle in neutral, check the transmission fluid level.
3. Add fluid as needed.
4. Drive vehicle making sure transmission is warm, then recheck fluid level.

(Page 2)

**Warning:** Installation of accessories should only be undertaken by those with mechanical knowledge and are familiar with working on vehicles. Always use eye protection (goggles, safety glasses or shield). Park the vehicle in a well lit area, on level ground and apply the parking brake. Only work on a cold vehicle that has been sitting overnight, failure to do so will result in severe burns and injury. Before starting the vehicle, make sure no tools or any other items are left under hood that could interfere with or be drawn into moving parts of the engine. Failure to follow instructions can lead to severe damage and personal injury.

# FITTING GUIDE

## Dodge/Jeep

Part No.

**13034**

Fits 1999-2003 Dodge Trucks, Vans with 5.9L, 5.2L, 3.9L Engines



9/16"-24  
45°SAE Fittings  
Male & Female

## Dodge/Jeep

Part No.

**13028**

Barbed Splicer Fittings

Fits 1960-1997 Dodge Trucks with rubber transmission lines

Fits 1983-2012 Jeep with 5.2L, 4.2L, 4.0L, 2.5L Engines with rubber transmission lines



## Insta-Dapt

Part No.

**13004**

Fits most vehicles with 5/16" transmission lines. Includes male and female threads.



## Dodge Dakota

Part No.

**13030**

Fits 1999-2005 Dodge Dakota



9/16"-18  
37°JIC Fitting

## Ford/Mercury

Part No.

**13014**

Fits 1983-2012 Ford/Mercury Cars, Trucks, Bronco, Expedition, Ranger, Vans w/ 7.5L, 7.3L, 6.9L, 6.6L, 5.8L, 5.4L, 5.0L, 4.9L, 4.7L, 4.6L, 4.2L, 4.0L, 3.8L, 3.0L, 2.9L, 2.8L, 2.5L, 2.3L Engines  
Fits 1983-2007 Mercury Cars w/ 5.8L, 5.0L, 4.6L, 3.8L, 3.0L, 2.5L, 2.3L Engines

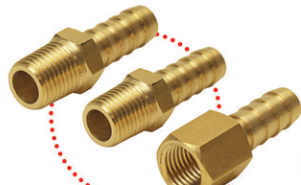

1/4" NPT M/F  
3/8" NPT  
Male Fittings

GM

Part No.

**13018**

Fits 1981-2000 Buick w/ 5.7L, 3.8L, 3.3L, 3.1L, 2.5L, 2.4L, 2.3L, 2.2L Engines  
Fits 1988-2007 Cadillac Cars, Trucks with 6.2L, 6.0L, 5.7L, 5.3L, 4.9L, 4.6L, 4.5L, 4.1L, 3.0L Engines  
Fits 1987-2012 Chevrolet Cars, SUVs, Chevrolet, GM Trucks, Vans w/ 8.1L, 7.4L, 6.5L, 6.0L, 5.7L, 5.3L, 5.0L, 4.8L, 4.3L, 3.8L, 3.4L, 3.2L, 2.4L, 2.3L, 2.2L Engines  
Fits 1996-2001 Oldsmobile Bravada with 4.3L Engine  
Fits 1983-2005 Pontiac Cars, SUVs with 5.7L, 5.0L, 3.8L, 3.4L, 3.1L, 2.4L, 2.2L, 1.6L Engines



5/8" Inverted  
Flare Fittings

ADD AUXILIARY COOLER  
WITHOUT ALTERING  
FACTORY TRANSMISSION  
LINES



5/8" Inverted  
Flare Fittings

## Ford/Lincoln Trucks & SUV's

Part No.

**13025**

Fits 1998-2012 Ford/Lincoln Trucks & SUV's, Blackwood, Excursion, Expedition, Explorer, Navigator, Ranger with 7.3L, 6.9L, 6.8L, 5.4L, 5.0L, 4.6L, 4.0L, 3.0L, 2.5L Engines

GM

Part No.

**13035**

Fits 1993-2012 Buick w/ 4.6L, 4.2L, 3.9L, 3.8L, 3.6L, 3.5L, 3.4L, 3.3L, 3.1L, 2.5L, 2.4L, 2.3L, 2.2L Engines  
Fits 1993-2012 Cadillac 6.2L, 6.0L, 5.7L, 5.3L, 4.9L, 4.6L, 4.5L, 4.1L, 3.0L Engines  
Fits 2000-2012 Chevrolet Cars, SUVs, Chevrolet, GM Trucks, Vans with 3.8L, 3.4L, 6.0L, 5.3L, 4.8L, 4.3L, 4.2L, 3.7L, 3.5L, 3.4L, 2.9L, 2.8L Engines  
Fits 2003-2007 Isuzu SUVs with 4.2L, 5.3L Engines  
Fits 2002-2004 Oldsmobile Bravada w/ 4.2L Engine  
Fits 2001-2007 Pontiac with 3.9L, 3.8L, 3.5L, 3.4L, 3.1L Engines



Snap in Tube  
Fitting

## Ford/Lincoln/Mercury

Part No.

**13024**

Fits 1983-2012 Ford/Lincoln/Mercury Cars, Trucks, Blackwood, Bronco, Expedition, Navigator, Ranger, Vans with 7.3L, 6.9L, 5.8L, 5.0L, 4.9L, 4.6L, 4.2L, 2.9L, 2.8L, 2.3L Engines

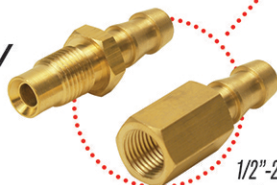

1/2"-20 Inverted  
Flare Fittings



## 5/16" Tube to 3/8" Barb

Part No.

**13031**

5/16" Transmission Cooler Line to 3/8" NPT Hose Barb



## 3/8" Tube to 3/8" Barb

Part No.

**13032**

3/8" Transmission Cooler Line to 3/8" NPT Hose Barb



## 1/2" Tube to 1/2" Barb

Part No.

**13033**

1/2" Transmission Cooler Line to 1/2" NPT Hose Barb