

11736**1995-97 VOLKSWAGEN PASSAT WAGON**

12/5/2012

GROSS LOAD CAPACITY WHEN USED AS A WEIGHT CARRYING HITCH: 2,000 LBS. TRAILER WEIGHT & 200 LBS. TONGUE WEIGHT.

*****DO NOT EXCEED VEHICLE MANUFACTURER'S RECOMMENDED TOWING CAPACITY.*****

WARNING: ALL NON-TRAILER LOADS APPLIED TO THIS PRODUCT MUST BE SUPPORTED BY 18050 STABILIZING STRAPS.

**** FAILURE TO PROPERLY SUPPORT NON-TRAILER LOADS WILL VOID PRODUCT WARRANTY****

HAVING INSTALLATION QUESTIONS? CALL TECHNICAL SUPPORT AT 1-877-287-8634

Parts List			
ITEM	QTY	PART NUMBER	DESCRIPTION
1	1	CM-11736-MB	.250" PLATE
2	4	3/8"	FENDER WASHER
3	4	3/8 - 16 x 1 1/4	HEX BOLT
4	4	7/16-14 x 1 1/4	HEX BOLT
5	4	7/16-14	HEX FLANGE NUT
6	4	HFN3816	HEX FLANGE NUT

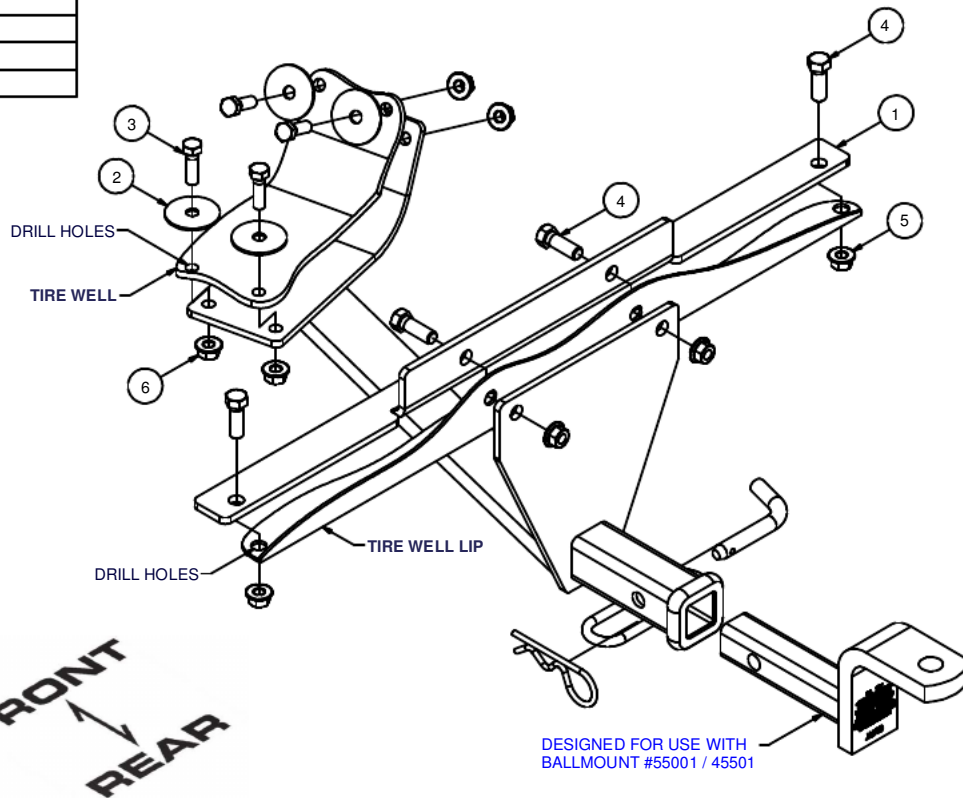
HITCH WEIGHT: 22 LBS.INSTALL TIMEPROFESSIONAL: 20 MINUTESNOVICE (DIY): 40 MINUTESINSTALL NOTES:

- DRILLING REQUIRED
- REMOVE SCREWS
- TEMPORARILY REMOVE SPARE TIRE
- SILICONE SEAL HARDWARE

INSTALLATION STEPS

1. Under the rear of vehicle, locate and remove six screws holding the center plastic strap attached to bumper fascia. Temporarily remove spare tire from inside car.
2. Being cautious of internal wires in trunk area, place main body inside trunk, centered on rearmost lip.
NOTE: The center two mounting holes are not on the centerline of the main body, it must be positioned with holes at 1 1/8" from surface lip.
3. Using main body as a drill template, drill mounting holes through tire well lip.
4. Attach hitch to main body as shown.
5. Using hitch as a drill template, drill (4) remaining holes through the tire well. Install fasteners as shown with fender washers used inside of tire well..
6. Torque all 7/16" hardware to 70 lb.-ft. and all 3/8" hardware to 45 lb.-ft.
7. Use silicone sealant to seal hardware installed through tire well.
8. Reinstall spare tire and screws removed in Step 1.

PERIODICALLY CHECK THIS RECEIVER HITCH TO ENSURE THAT ALL FASTENERS ARE TIGHT AND THAT ALL STRUCTURAL COMPONENTS ARE SOUND.

Curt Manufacturing Inc., warrants this product to be free of defects in material and/or workmanship at the time of retail purchase by the original purchaser. If the product is found to be defective, Curt Manufacturing Inc., may repair or replace the product, at their option, when the product is returned, prepaid, with proof of purchase. Alteration to, misuse of, or improper installation of this product voids the warranty. Curt Manufacturing Inc.'s liability is limited to repair or replacement of products found to be defective, and specifically excludes liability for incidental or consequential loss or damage.