

# 21100, 21150, 21155

**Note:** These instructions are also for the listed kits in all optional finishes. Example 21100-06, 21100-07, 21100-08



## Instructions

Questions please call 1-888-729-9070

10-18-19

# Optional parts for kits

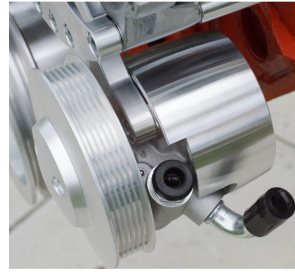

Part # 480 or 480-08  
type II power steering  
pump billet housing  
cover

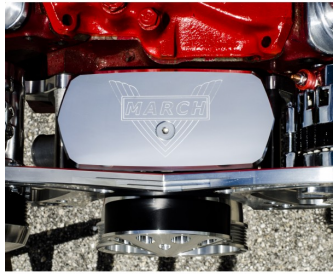

Part # 224 or  
224-08 Water  
pump cover



We carry a selection of  
power steering remote  
reservoirs to complete  
your type II power  
steering installation.



Part # 418 or  
418-08 a/c  
manifold wrap  
around fittings



Stainless braided hose  
packages for plumbing  
your power steering  
system



Part # P545  
320amp alternator



Part # P306 power  
steering psi regulator  
kit. Typically required  
for most rack & pinion  
systems



We are specialists in matching  
aftermarket air conditioning  
systems such as Vintage Air, Old  
Air Products and Nostalic Air with  
our drive systems. Please contact us  
for help in selecting a matching kit  
for your application. 888-729-9070

### **Main front bracket assembly 21101**

1-21101-A .....main bracket  
3-S339.....3/8 x 3" threaded stud  
1-S340.....3/8 x 4" threaded stud  
3-S777.....2.820" stainless spacer  
1-S770.....1.900" stainless spacer  
1-S277.....3/8-16 x 4 3/4" shcs  
8-S248.....3/8-16 x 1" shcs  
1-S550.....M8-1.25 x 20mm shcs  
2-S553.....M8-1.25 x 35mm shcs  
2-S622.....3/8 lock nut  
2-MM100.....bolt bushing  
1-S750.....heater hose barb

### **Alt rear support bracket assembly 21602**

1-21602-A .....alt support bracket  
1-TP3-1.890.....alum. spacer 1.890" long  
2-S675.....w/p gaskets

### **A/c rear support bracket assembly 21603**

1-21603-A .....a/c support bracket  
1-TP3-.150.....spacer .150" long  
1-S221.....5/16-18 x 1 3/4" hex head  
1-S660.....5/16 washer  
2-S675.....w/p gaskets

### **Tensioner assembly 21124**

1-21124-A .....tensioner bracket  
1-759-A.....tensioner cover  
1-P758.....tensioner  
2-S022.....8-32 x 3/8" shcs  
1-S162.....5/16-18 x 3.00" shcs  
2-S660.....3/8 x 3/4 washer  
1-S616.....5/16-18 lock nut

### **Rem p/s bracket assembly 21108 (Kit 21150)**

1-21108-A .....power steering bracket  
2-S551.....M8-1.25 x 25mm shcs

### **Saginaw p/s bracket assembly 21109-09 (Kit 21155)**

1-21109A-09.....front p/s bracket  
1-21109B-09.....rear p/s bracket  
1-20114C-09.....spacer block  
2-S270.....3/8-16 x 3 1/2" shcs  
2-S311.....3/8-16 x 3/4" hex head  
1-S312.....3/8-16 x 1" hex head  
1-TP3-.150.....spacer .150" long

### **Pulleys**

1-6301-A.....crank pulley  
3-S292.....3/8-24 x 1" shcs  
1-6302-A.....water pump pulley  
4-S183.....5/16-24 x 5/8" shcs  
1-221-A.....alterator fan  
1-206-A.....alternator pulley  
1-306-A.....alt pulley cover  
3-S028.....8-32 x 1" shcs  
1-394-A.....a/c clutch cover  
3-S124.....1/4-20 x 3/4 bh  
3-S520.....M6-1.0 x 20mm bh  
1-S685.....11/16 alt lock washer

### **Rem p/s kits (21150 )**

1-650-A.....remote p/s pulley  
3-S144.....5/16-18 x 7/8" shcs

### **Saginaw p/s kits (21155 )**

1-535-A.....keyway p/s pulley  
1-302-A.....p/s pulley nose cover  
3-S022.....8-32 x 1" SHCS

### **Accessories**

1-P112.....cast alum water pump  
1-P412.....chrome alum 7176 compressor  
  
1-P572.....chrome alum alternator  
  
1-417.....A/c manifold

### **Rem p/s kits (21150 )**

1-P313.....cast alum type 2 rem. p/s pump

### **Saginaw p/s kits (21155 )**

1- P304.....chrome Saginaw keyed p/s pump

**Note : We do NOT include belts with kits.  
We do recommend Dayco, Goodyear or  
Continental brands only. These are available  
through most local auto parts stores.**



### Step-1

Make sure all surfaces are clean. Install one (S340) 3/8 x 4" threaded stud in the lower passenger side hole. In the remaining three holes install three (S339) 3/8 x 3" threaded studs. When installed the 4" stud should be 3-5/16" from the face of the block and the three 3" studs should be 2-3/8" from the face of the block.

### Step-2

Install the (21602-A) alternator rear support bracket on the drivers side and the (21603-A) rear a/c support on the passenger side. Use four (S675) gaskets, two in between the brackets and the block surface and two in between the face of the brackets and the water pump.

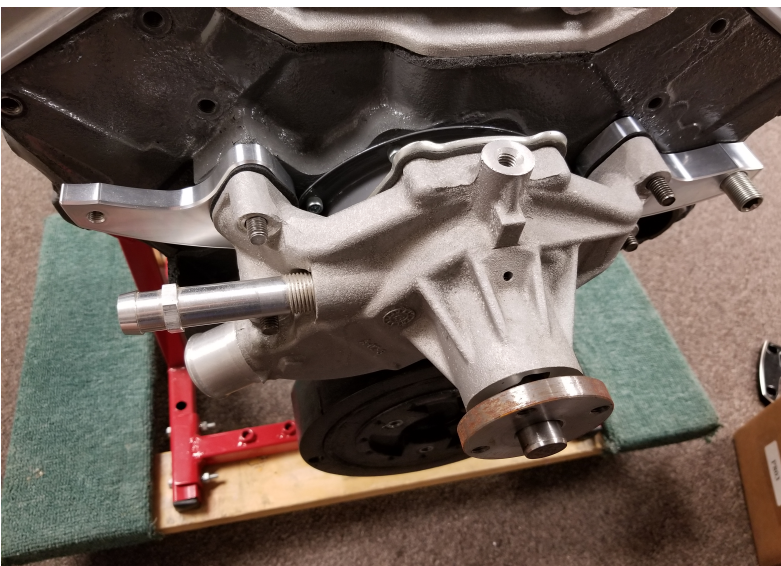
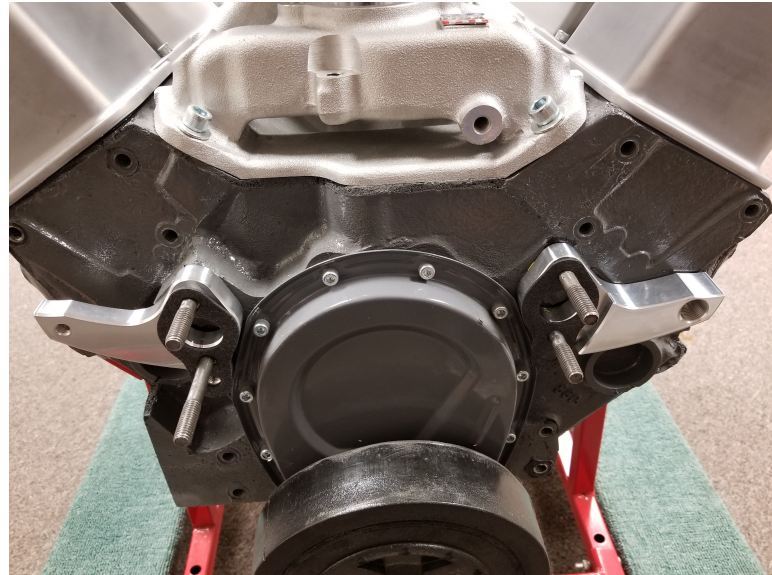

### Step-3

Slide (P112) aluminum water pump over threaded studs and install (S750) barbed heater hose fitting in to water pump.



#### Step-4

Install (S770) 1.900" long stainless spacer onto the bottom passenger side stud. Then install three (S777) 2.820" long stainless spacers to the remaining studs as shown. All four spacers should extend from the block evenly.

#### Step-5

Install main bracket (21101-A) to the four threaded spacers with four (S248) 3/8-16 x 1" SCHS.



#### Step-6

Install (6302-A) water pump pulley to water pump with four (S183) 5/16-24 x 5/8" SHCS

#### Step-7

Install (6301-A) crank pulley with three (S292) 3/8-24 x 1" SCHC.



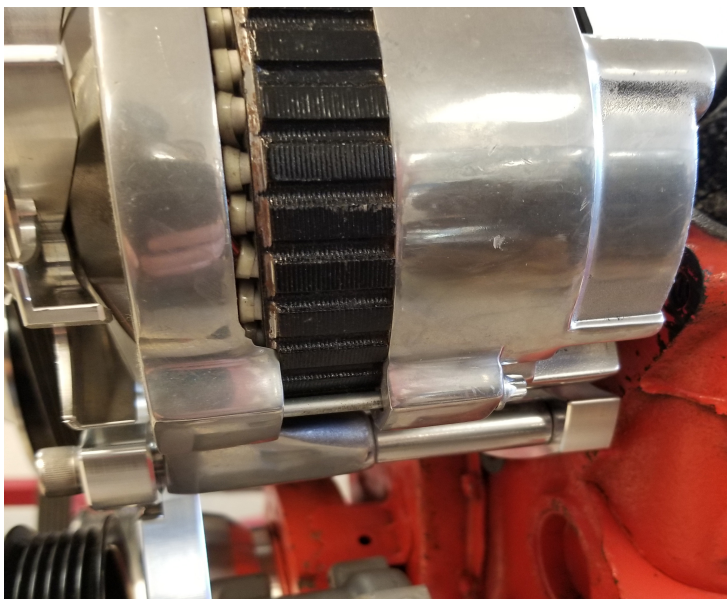

### Step-8

Install the (P572) alternator in between the main bracket and rear support bracket on the driver side. Use a (TP3-1.890) spacer behind the lower alternator ear and the rear bracket. Then secure with a (S277) 3/8-16 x 4-3/4" SHCS.

### Step-9

Secure alternator upper ear to main bracket slot with a (MM100-A) bolt bushing and a (S553) M8-1.25 x 35mm SHCS as shown. Now install alt fan (221-A) and pulley (206-A) and secure with (S685) lock washer and nut. Use impact to install to 70 lbs. Now install cover (306-A) with three (S028) 8-32 x 1" SHCS.



### Step-10

To mount the (P412) a/c compressor, Use one (S550) M8-1.25 x 25mm SHCS through the front of the lower hole on the main bracket. On the top ear use a (MM100-A) bolt bushing and a (S553) M8-1.25 x 35mm SHCS through the slot on the main bracket. Now install clutch cover (394-A) with either three (S520) M6-1.0 x 20mm or three (S124) 1/4-20 x 3/4 button head bolts. These are to be installed a 1/4 turn past finger tight.

### Step-11

The rear mounting ear will use a (S221) 5/16-18 x 1 3/4" HH through the front of the rear compressor ear with a (S660) 5/16 washer and thread in to rear support bracket. Use a TP3-.150 spacer between rear ear of compressor and bracket if there is a gap.



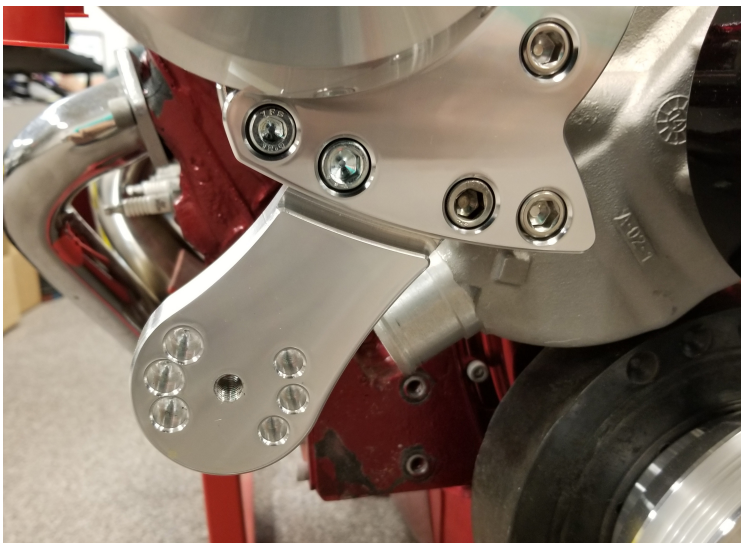

### Step-12

Install (21124-A) tensioner bracket to main bracket on passenger side with two (S248) 3/8-16 x 1" SHCS.



### Step-13

Install (P758) pulley tensioner to tensioner bracket with one (S162) 5/16-18 x 3" SHCS, two (S660) 5/16 washers and one (S616) 5/16-18 lock nut. Install tensioner cover (759-A) with two (S022) 8-32 x 3/8" SHCS after belt is on.

**Note: There are 3 positions the tensioner can be installed. Install in the middle location.**

**The additional positions and slotted adjustments on the main bracket are to aid in correcting variations in belt lengths or stretched belts. This will also help with custom applications.**

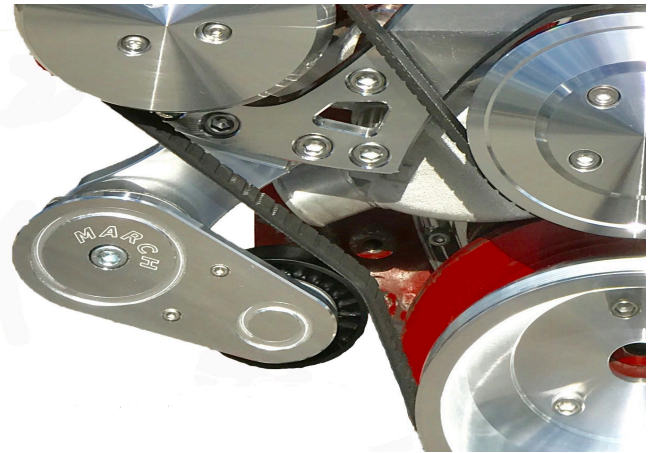

**For kits with type 2 p/s (21150)**

### Step-14

Install (P313) power steering pump to backside of (21108-A) power steering bracket with two (S551) M8-1.25 x 25mm SHCS.



### Step-15

Install power steering bracket to main bracket with two (S248) 3/8-16 x 1" SHCS.





### Step-16

Install (650-A) power steering pulley to pump with three (S144) 5/16-18 x 7/8" SHCS

For kits with Saginaw power steering (21155)

### Step-17

First **Remove stud** from back of (P304) power steering pump.

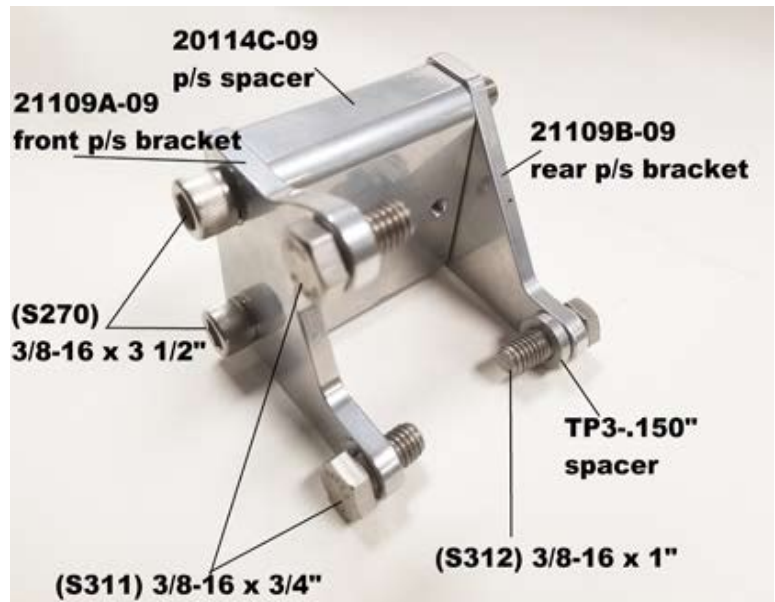

### Step-18

Install (21109A-09) to front of pump as shown with two (S311) 3/8-16 x 3/4" hex heads.







### Step-19

Install (21109B-09) rear support bracket to backside of pump where stud was with a (S312) 3/8-16 x 1" hex head. Use (TP3-.150") spacer in between pump and bracket.



### Step-21

Install pump and bracket assembly to the lower driver side of the engine block with two (S270) 3/8-16 x 3 1/2" SHCS and (20114C-09) in between the front and rear brackets as shown in photo.

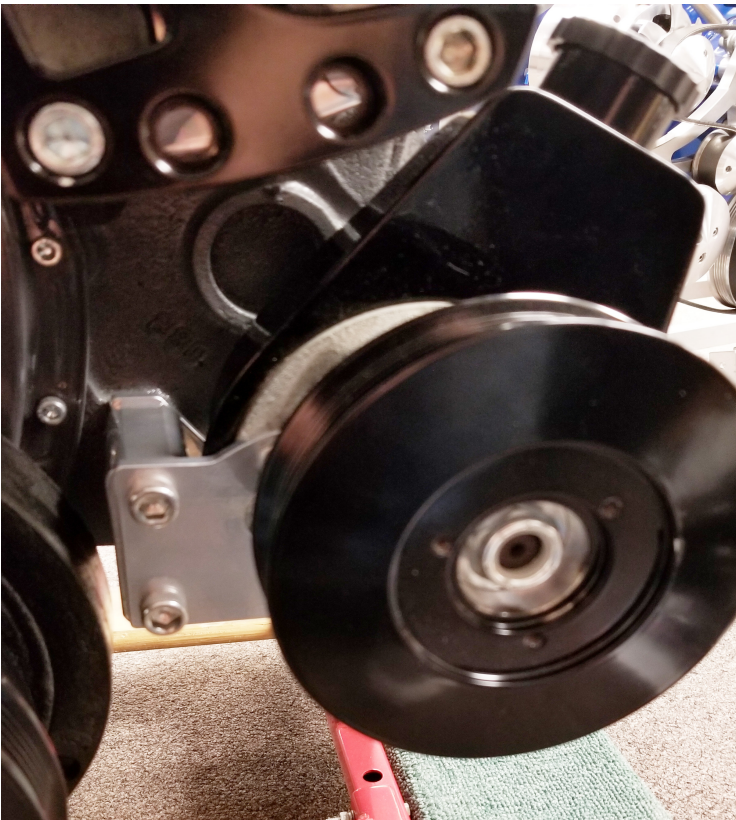

### Step-22

Install (535-A) to power steering pump and retain with lock nut. **Make sure woodruff key is straight on shaft of pump and does not slide up in rear upon install.** Now install pulley nose cover (302-A) with three (S022) 8-32 x 3/8" SHCS.

### Step-23

For kits **not** using remote power steering. Install two (S248) 3/8-16 x 1" SHCS in lower driver side holes of main bracket and secure with two (S622) 3/8-16 lock nuts.

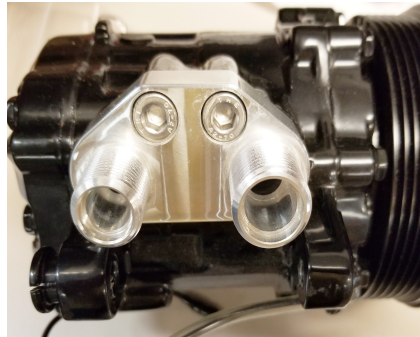
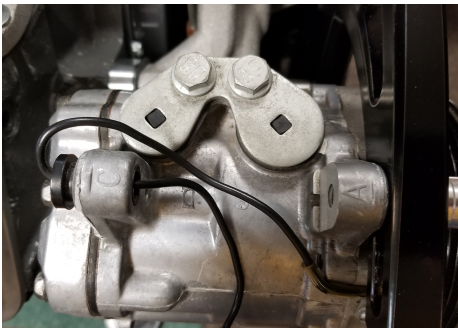
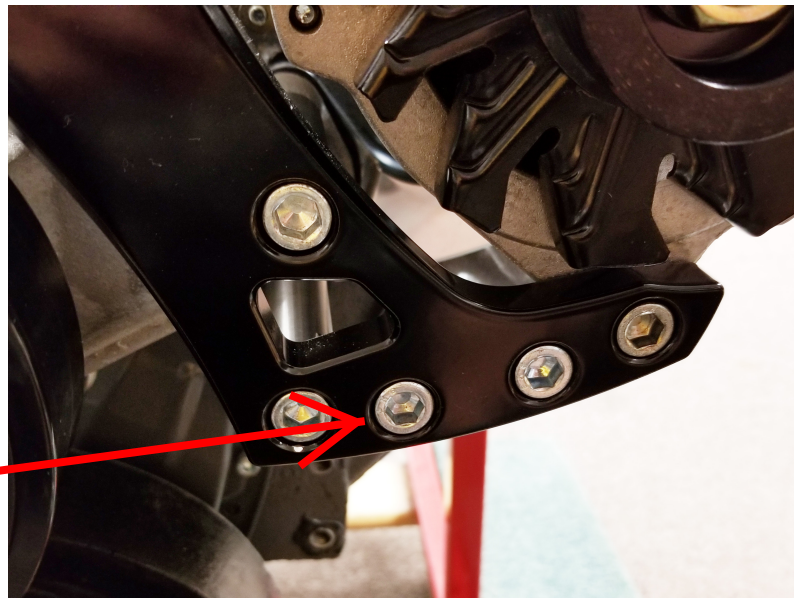

### Step-24

If installing air conditioning at this time, Remove block off plate from compressor and then install (417A-04) with two (S550) M8-1.25 x 20mm SHCS

### Step-25

**Installing belts.** We recommend **Dayco** brand belts. To install belt make sure alternator and a/c compressor are all the way inward on the slots of the main bracket. Use a 1/2" drive to pull and release the tensioner. You can adjust the position of the components in the slots as well as adjust the position of the tensioner if needed to aid in custom applications or if a belt is too loose. See pictures below for routing and belt sizes.

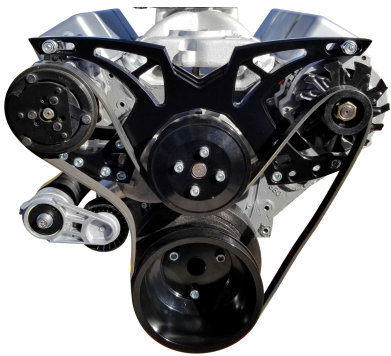

**Kit21100 use a 59" 6 rib belt (Dayco 5060590)**

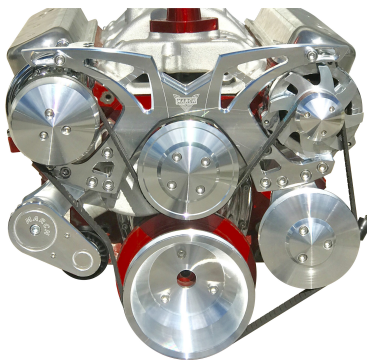

**Kit 21150 with Type 2 p/s use a 62" 6 rib belt (Dayco 5060620)**



**Kit 21155 with Saginaw p/s use a 64" 6 rib belt (Dayco 5060640)**

LIMITED WARRANTY

March Performance warrants to the original retail purchaser that for a period of ninety (90) days from the date of purchase, March Performance will repair or replace, at their option, any Product, which is found to be defective in material or workmanship.

Exclusions from Warranty Coverage

March Performance does not warrant any Product that is damaged from abuse, misuse or misapplication or not used for its intended purposes.

This Limited Warranty does not cover or apply to any damage or loss sustained to the engine or any other parts which may have been caused by the defective Product and does not cover or apply to any personal injury, labor charges or any other incidental costs for damages caused by the defective Product. THIS IS THE ONLY EXPRESS WARRANTY GIVEN WITH RESPECT TO YOUR PRODUCT. ALL OTHER EXPRESS WARRANTIES, GUARANTEES, OR STATEMENTS REGARDING THE PRODUCT, WHETHER WRITTEN OR VERBAL, ARE HEREBY DEEMED NULL AND VOID AND OF NO EFFECT.

Normal wear and tear and damage to the Product not caused by March Performance are also excluded from this Warranty.

DISCLAIMER OF OTHER WARRANTIES

EXCEPT TO THE EXTENT PROHIBITED BY APPLICABLE LAW, ANY IMPLIED WARRANTY WHETHER OF MERCHANTABILITY, FITNESS FOR A PARTICULAR PURPOSE, OR WARRANTY, SOME STATES DO NOT ALLOW LIMITATIONS ON HOW LONG AN IMPLIED WARRANTY WILL LAST SO THAT THE PRECEDING LIMITATION MAY NOT APPLY TO YOU.

Limitation on Remedies

REPAIR OR REPLACEMENT AS PROVIDED IN THIS WARRANTY IS YOUR EXCLUSIVE REMEDY. MARCH PERFORMANCE SHALL NOT BE LIABLE FOR ANY INCIDENTAL OR CONSEQUENTIAL DAMAGE FOR BREACH OF ANY EXPRESS OR IMPLIED WARRANTY ON THE PRODUCT. SOME STATES DO NOT ALLOW THE EXCLUSION OR LIMITATION OF INCIDENTAL OF CONSEQUENTIAL DAMAGES SO THE PROCEEDING LIMITATIO OR EXCLUSIONS MAY NOT APPLY TO YOU. YOU HAVE NO RECOURSE OR REMEDY FOR DAMAGE OR DEFECT CAUSED BY MISUSE, ABUSE OR NEGLIGENCE.

THIS WARRANTY GIVES YOU SPECIFIC RIGHTS AND YOU MAY ALSO HAVE OTHER RIGHTS, WHICH MAY VARY FROM STATE TO STATE.

Your Responsibilities:

- 1. Use and install the Product only for its intended purpose.
2. To avail yourself of this Limited Warranty, return the Product with a copy of the paid receipt, postage paid to: MARCH PERFORMANCE 16160 PERFORMANCE WAY NAPLES, FL 34110
3. When returning the Product, you must follow the directions set forth on the Warranty/Return Form on the reverse side of this Limited Warranty. If you no longer have the Warranty/Return Form, one may be obtained by contacting March Performance during normal business hours at: (888) 729-9070.
4. Shipping and/or transportation costs returning the Product to March Performance and any damage caused during shipping are your responsibility. March Performance will pay for shipping and/or transportation costs incurred in returning the Product to you.

LIMITED WARRANTY WARRANTY/RETURNS FORM

No product mounted is considered for credit unless it is a manufacturer defect.

All products returned for any reason must reference an authorization number (RGA). The RGA number is obtained by calling place of purchase during normal business hours. Any product returned without the RGA# written on the return package next to the return shipping label will be refused.

All returns must ship via UPS and be properly packaged in the original carton. Return freight charges are the responsibility of the customer unless the product was shipped in error.

March product returned after (1) year from date of purchase will not be accepted unless it is found to be a manufacturer defect. The customer must include a written statement describing the alleged product defect. The complete Limited Warranty is set forth on the reverse side.

- 100% credit issued on manufacturer defects
20% return fee on all reshelvable product
30% return fee on all repairable product

NO CREDIT WILL BE ISSUED ON RETURNED PRODUCT BEYOND REPAIR

March Performance thoroughly inspects all returns. It is the sole discretion of March Performance in determining the condition of all returned merchandise.

To receive replacements at no charge the original product must first be received and inspected by March Performance for determination. Immediate replacements may be purchased and later credited upon inspection determination.

Please Complete the Information below, detach and include with returned product.

Form fields for RGA#, CT#, Issued by, Date, Purchaser's Name, Phone, Address, Purchased Directly Through, Invoice#, Product ID, Invoice Date, Reason.

\*\* MOUNTED PRODUCTS ARE NONREFUNDABLE \*\*