



Strong As An Ox™

BX3609 Installation Instructions

2002-07 Subaru Impreza Outback, (Incl. Sport & WRX)

Serial No.

The front fascia, metal bumper, and head light assembly is removed for baseplate installation. Holes need to be drilled and trimming is needed on fascia. The attachment tabs for this base plate are 24" center to center and a height of 14". The BX8869, Bulb and Socket Kit, is available for the base plate.

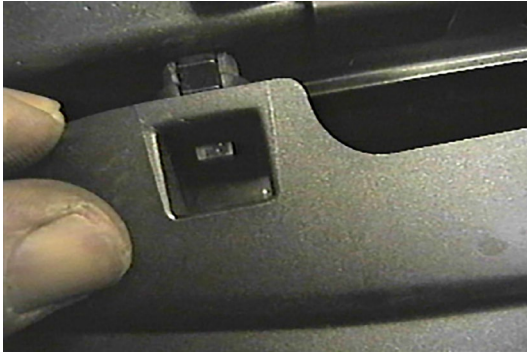

1. Insert small flat screw driver into clips to release all four, remove grill, and set aside.

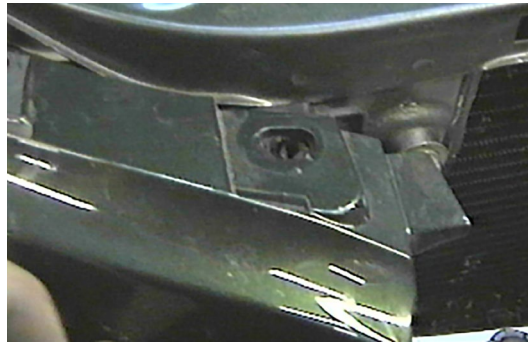

2. Remove two push pins on the top, one just behind, pull forward, and set aside outer grill supports. On top side of fascia are 5 push pins to be removed.

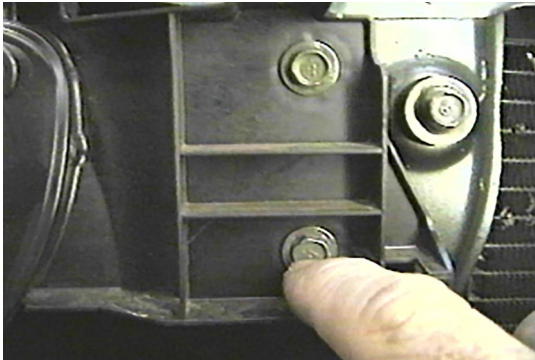

3. Using the 10MM socket remove the three metric bolts from head light assemblies and set aside. Remove push pin just under head light assembly, both sides.

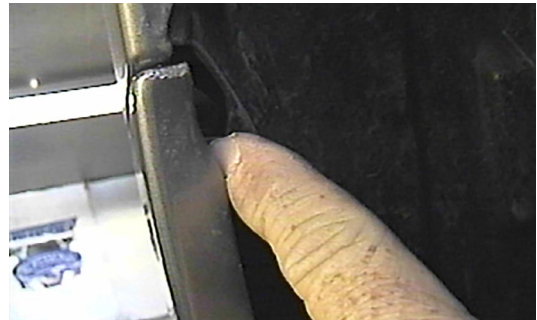

4. Remove phillips head push pin just forward of front tire and one inside wheel well on fascia.



5. Remove two wing bolt push pins on the under side of fascia and one push pin in the center.

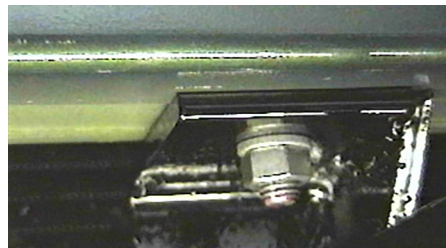

6. Hold baseplate to align with existing holes on under side of metal bumper. Insert item 2 into metal bumper ends to align with these holes and apply items 6 and 7. **Be sure and use loctite on all bolts before tightening.**



Strong As An Ox™

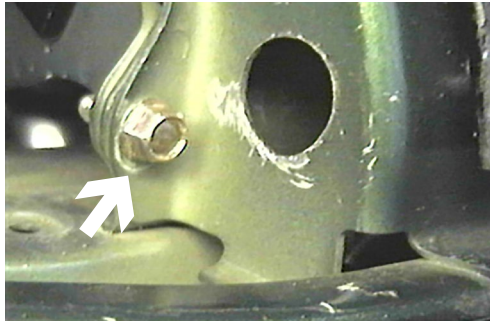

7. **2002-03 Models:** With the 14MM socket remove the two outer bolts from the metal bumper, both sides. **2004 Models:** Replace factory metric bolt with 8MM-1.25 x 30MM Hex Bolt.

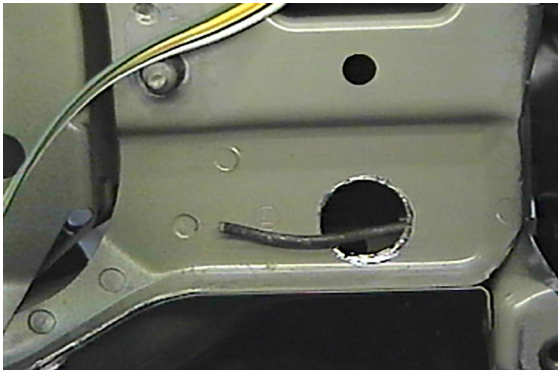

9. **2002-03 Models:** Using the 1 1/4" hole saw, cut hole into lower chamber of frame end, both sides.

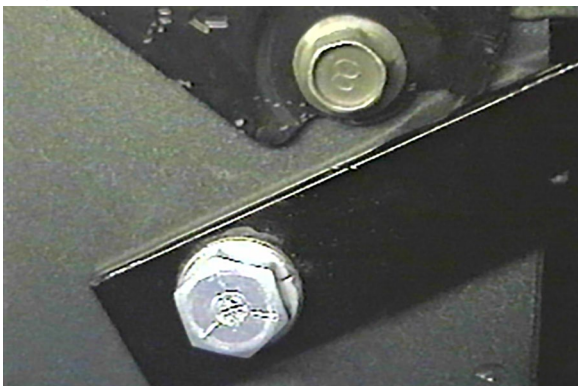

11. **2002-03 Models:** Align support brace with existing hole. Hole may need to be drill out with the 13/32" drill bit. Insert item 3 into drilled 1 1/4" hole to align with 13/32" hole, items 5 and 6, and tighten. **Be sure and use loctite on all bolts before tightening. Go to step 14.**

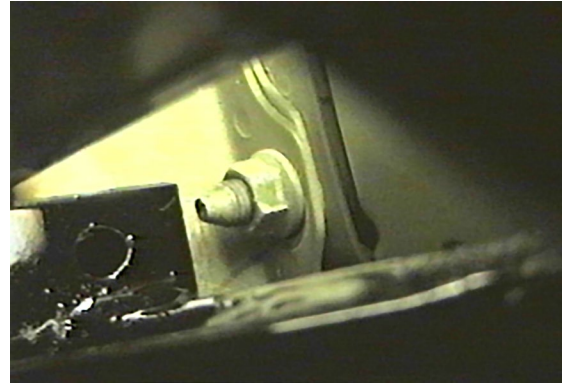

8. **2002-03 Models:** Remove the two metric nuts from metal bumper with the 14MM socket and set metal bumper/ baseplate aside. **2004 Models: Do not remove metal bumper. Go to step 12.**

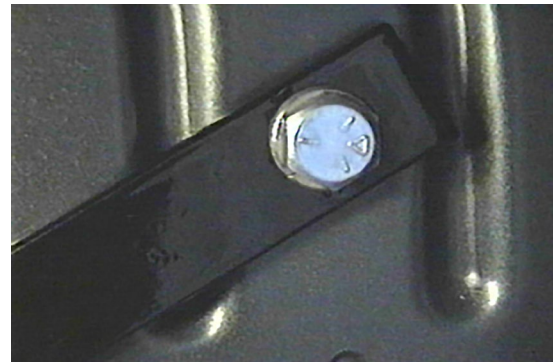

10. **2002-03 Models:** Drill out existing hole with the 13/32" drill bit, on frame rail. Insert item 3 into frame end to align with drilled hole, items 5, 6 and 8. **Be sure and use loctite on all bolts before tightening.**



12. **2004 Models:** Drill out existing hole with the 13/32" drill bit if needed, on frame rail. Insert item 4 into opening on bottom of frame to align with drilled hole, items 5, 6 and 8. **Be sure and use loctite on all bolts before tightening.**



Strong As An Ox™



13. Insert side brace on metric bolt from step 7, hand tighten 8MM lock washer and hex nut. Align support brace and side brace holes with webbing on back of frame, mark and drill webbing with the 13/32" drill bit. Insert 3/8-16 bolt into support brace, side brace, drilled hole and tighten lock washer and hex nut. Tighten all metric bolts and nuts. **Be sure and use loctite on all bolt before tightening.**

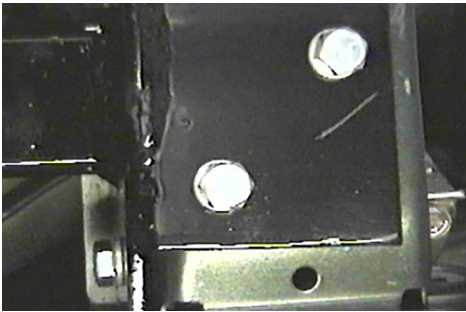

15. Using the 1 1/4" hole saw, drill hole in the side of metal bumper. Refer to photo in step 7 for hole location. Insert item 3 into 1 1/4" hole and fasten to items 5 and 6 for the two front holes and lower side hole, both sides. Tighten all bolts. **Be sure and use loctite on all bolt before tightening.**

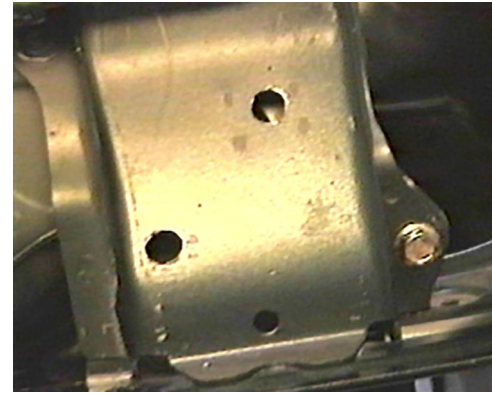

14. While baseplate is still attached to metal bumper, drill remaining holes with the 13/32" drill bit. Using baseplate as a template, drill 1 1/4" hole in the side of metal bumper, refer to photo in step 7 for location.



16. Reinstall metal bumper and insert item 4 into 1 1/4" hole on metal bumper to remaining hole in baseplate with items 5 and 6, tighten all bolts. **Be sure and use loctite on all bolt before tightening.**

17. Hold fascia into place, mark, and trim. Install fascia, head light assemblies, and grill.

18. The dimensional variations between otherwise identical cars can be considerable. While the location and size of the holes in the baseplate were designed to allow for easy installation, it may be necessary to file a hole slightly to allow a bolt to clear.

19. Install the tow bar and safety cables according to the instructions included in their packages.

20. Do **not** substitute other devices if the tow bar pin and clip are lost.

21. DEALER OR INSTALLER: BE CERTAIN THE USER RECEIVES THE INSTRUCTION SHEET.



Strong As An Ox™

Tools Required

10MM Socket
12MM Socket
14MM Socket

Loctite Blue
9/16" Socket
1 1/4" Holes Saw

13/32" Drill Bit
Vise Grips
13/32" Transfer Punch

Parts List

Ref. No.	Qty.	Part No.	Description
1	1	61-5659	Weldment, Base Plate, BX3609
2	2	61-5676	Weldment, 3/8-16, Bolt Plate, with Wire
3	10	61-5208	Weldment, 3/8-16, Nut Plate, with Wire
4	4	61-4978	3/8-16 Whiz Nut, with Wire
5	12	201-0440	3/8-16 x 1 1/2 Hex Bolt, Grd. 5, ZP
6	14	203-0010	3/8 Lock Washer, ZP
7	4	202-0003	3/8-16 Hex Nut, ZP
8	2	102-6201	Support Brace, BX3609
9	2	201-0979	#12-14 x 1" Self Drilling Screw, ZP
10	2	202-0047	#10-32 Hex Nut
11	2	203-0054	#10 Lock Washer
12	2	201-0192	#10-32 x 1/2 Slot, Rd. Hd. Screw
13	2	101-5822	Adapter, 4 Way Connector
14	2	201-0446	8MM-1.25 X 30MM Hex Bolt, Grd 8.8, ZP
15	2	203-0107	8MM Flat Washer, ZP
16	2	203-0102	8MM Lock Washer, ZP
17	2	202-0118	8MM-1.25 Hex Nut, ZP
18	2	102-6460	Side Brace, BX3609
	2	226-0046	Baseplate Safety Cable, 36" CL III (Not Shown)
	4	229-0359	Quicklink, 3/8, ZP (Not Shown)

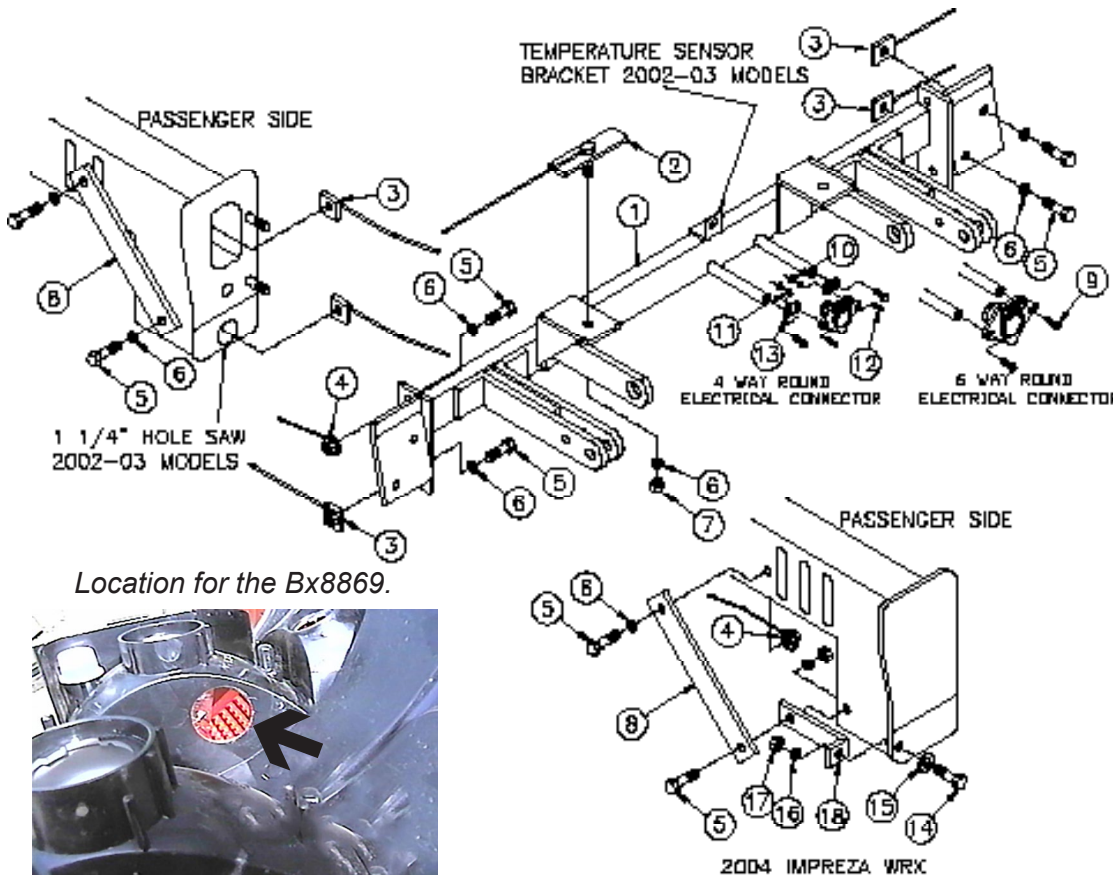

IMPORTANT: Use only genuine factory replacement parts on your Base Plate. Do not substitute homemade or nontypical parts. If a bolt is lost or in need of replacement, for your safety and the preservation of your Base Plate, be sure to use a replacement bolt of the same grade (Usually Grade 5, refer to parts list). Repair parts may be ordered through your nearest **Blue Ox** dealer or distributor.

General Information

1. Ensure that your product(s) are registered online at www.blueox.com. It is crucial to register your product(s) so that you may be alerted of product offerings, updates, upgrades, maintenance and safety bulletins, and/or recalls.
2. **It is the owner's responsibility to inspect all towing equipment for cracked welds, missing or worn parts and loose bolts before each towing trip.** Be sure to use Loctite® Red on all bolts and tighten to the recommended specifications.
3. **It is the owner's responsibility to hook up all towing equipment per manufacturer's instructions/recommendations.**
4. Remove the attachment tabs when not in use (if applicable).

Notice To Baseplate Installer

1. It is YOUR responsibility to watch for:

- Oil cooler and air conditioner lines
- Electrical wires and hoses
- Missing parts or attaching points on the frame

** If the baseplate is improperly installed and is against a wire or hose, it could cause fluid leaks or electrical shorts some time after the actual baseplate installation.

Permanent Baseplate Safety Cable Installation

Permanent baseplate safety cables are strongly recommended when towing a vehicle with a tow bar. The principle function of the permanent baseplate safety cables is to prevent the towed vehicle from breaking loose in the event the connection between the frame of the towed vehicle and the baseplate fails or becomes disconnected. The cables must be connected from the baseplate to the frame rail or cross member of the vehicle's frame. The illustrations below show the possible arrangements recommended by Blue Ox®. Each permanent baseplate safety cable must have an adequate weight rating for the towing system. The weight rating of the two (2) cables together will not qualify.

Do not mount the permanent baseplate safety cables against wires, hoses or brake lines.

These permanent baseplate safety cables should remain installed as long as the baseplate is installed on the vehicle. Permanent baseplate safety cables are to be used in conjunction with, and NOT a replacement for legally required safety cables attaching the towed vehicle to the towing vehicle.

OPTION #1

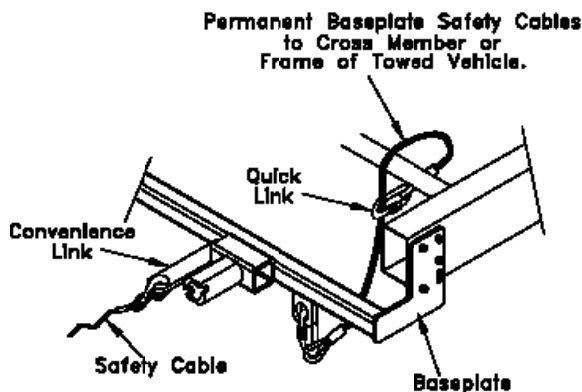

OPTION #2

