



BXH1002

2021-2024 Ford Bronco Installation Instructions

Please read the Installation Instructions prior to installing or operating this equipment.

1. Blue Ox® towing products and accessories are intended to be installed by Blue Ox® Dealers who are familiar with our products and have the equipment and knowledge necessary to do “fit work”. If needed, Blue Ox® Dealers can be found at www.blueox.com or by contacting our Customer Care Department at (402) 385-3051.
2. Many Blue Ox® receiver hitches are designed to use existing holes and hardware to mount the hitch to the vehicle. Even though bolts are there, do not assume they are adequate for receiver hitch mounting. Always use the hardware supplied in the hardware kit and existing hardware as specified in the installation instructions.

Serial Number

Bolt Torque Specifications

Torque in Foot-Pounds for Inch Bolts

Bolt Size	Grade 5	Grade 8
1/4"	10	14
5/16"	19	29
3/8"	33	47
7/16"	54	78
1/2"	78	119
5/8"	154	230
3/4"	257	380



If the rear of your vehicle looks different than this, please contact us at (402)385-3051.

Bolt Torque Specifications

Torque in Foot-Pounds for Metric Bolts

Bolt Size	Grade 8.8	Grade 10.9
6MM	6	8
8MM	16	22
10MM	31	40
12MM	54	70
14MM	89	117
16MM	161	230
18MM	222	318



WARNING

Failure to read and follow these instructions could result in separation of the towed item from the vehicle, causing property damage, loss of towed item, personal injury or death.



WARNING

Refer to your vehicle's owner's manual for maximum towing capacity. **DO NOT** exceed vehicle, pin or hitch weight ratings - failure to follow vehicle manufacturer's recommendations could result in damage to your vehicle, personal injury or death.

BXH1002
2021-2024 Ford Bronco
Installation Instructions

Hitch Type	Max Gross Trailer Weight (GTW)	Max Tongue Weight (TW)
Weight Carrying	4500 lb. (2041 kg)	675 lb. (306 kg)
Weight Distributing	4500 lb. (2041 kg)	675 lb. (306 kg)

Instruction Notes: The bumper is loosened and the exhaust is lowered and reinstalled for receiver hitch installation. If present the rear bracket is removed and is not reinstalled during installation.

Place all components that are removed on a flat, sturdy surface. All items will be reinstalled unless otherwise noted after the receiver hitch is installed.

The dimensional variations between otherwise identical vehicles can be considerable. While the receiver hitch was designed for easy installation, it may be necessary to tailor the hitch slightly to compensate for vehicle manufacturer's tolerances.

NOTICE

- Handling of some cosmetic parts when installing this product may require the use of protective covers, rags, specialty tools, etc. to prevent damage.
- When using power drills be aware of the dangers of torque and drill bit length.
- When using a reciprocating saw be aware of objects behind the cutting surface.
- Use a good quality paint to spray cut edges of frame to prevent rusting.
- Be sure that **ALL** electrical connections are plugged in and accessories are functioning properly.
- The receiver hitch is tested to your vehicle's tow ratings, verify vehicle's tow rating because it may differ from receiver and use whichever is less. Exceeding this weight will void the manufacturer's warranty.
- Tighten all bolts according to the torque chart provided unless specified.
- Dealer or installer be certain the user receives these instruction sheets.
- If the receiver hitch is in an accident, it must be replaced. **DO NOT** use it again! An accident can cause unseen damage and using it again could result in more damage or serious injury. **DO NOT** use the hitch if it is damaged or missing parts.
- **DO NOT** alter this product in any way. Modifying this product could change the integrity and lead to a loss of connection between the towed item and the tow vehicle.
- The weight rating of the hitch assembly must be greater than the gross weight of the trailer.
- Without proper information, towing can be dangerous. Understand all risks involved with towing before starting. For more information on towing safety, see "**The Trailer Handbook: A Guide to Understand Trailer and Towing Safety**" from the *National Association of Trailer Manufacturers*, www.NATM.com.
- Check that all bolted connections are at the correct torque specification on a regular basis. Complete a visual inspection before towing each time.
- Ensure that installation is performed by someone who is aware of the risks and has knowledge of hazards and proper safety procedures involved with adding components to the chassis of a vehicle and the tools needed for installation.

BXH1002
2021-2024 Ford Bronco
Installation Instructions

Tools Required

Ratchet
Torque Wrench
Exhaust Hanger Removal
Pliers or
5/8" Open End Wrench
13MM Socket
18MM Socket
18M Wrench
3/4" Socket
3/4" Wrench

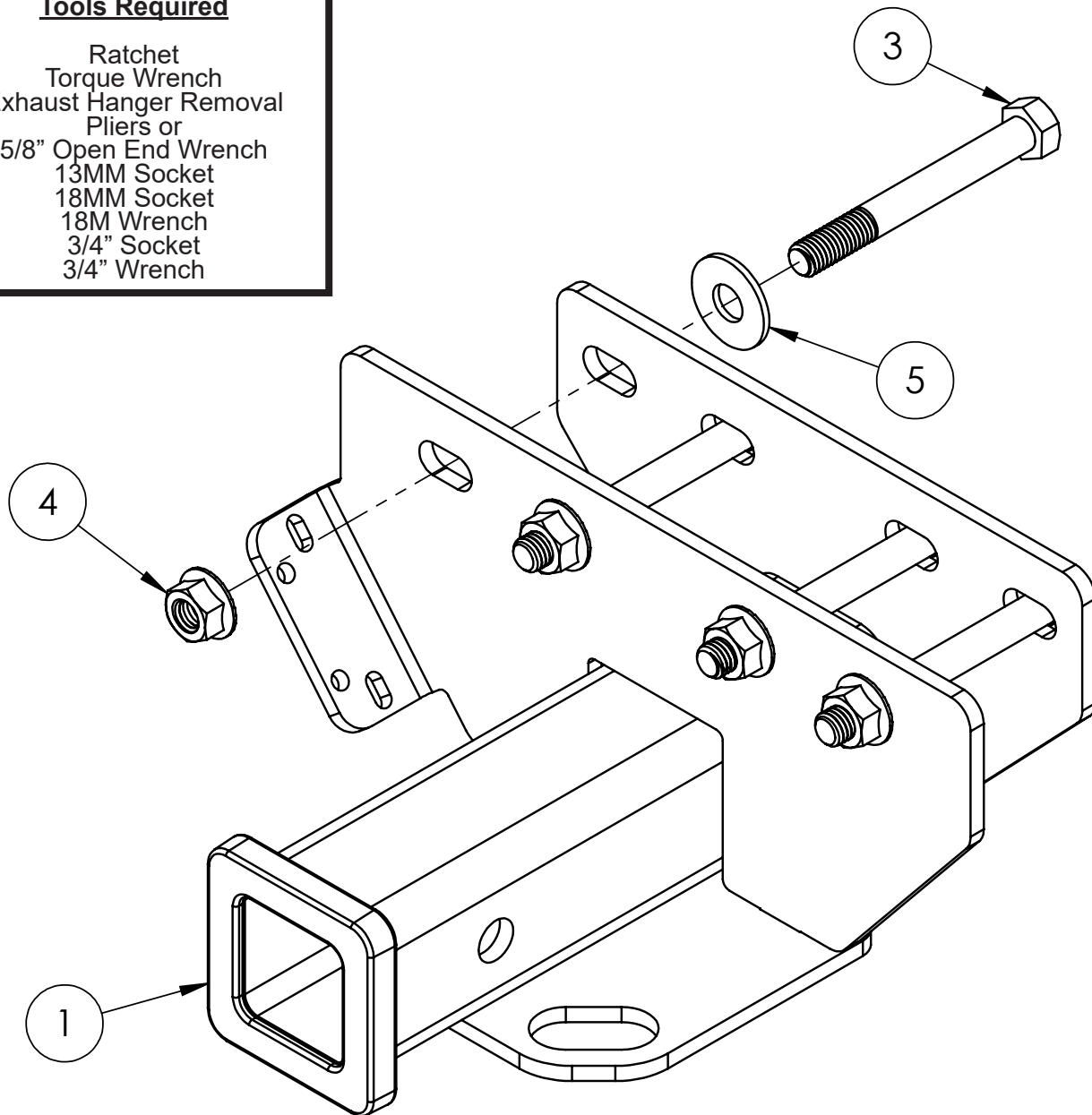

Item No.	Part No.	Description	Qty.
1.....	61-8690	Receiver, 2"	1
2.....	63-5032	Bolt Bag & Manual Package.....	1
3.....	201-1183	1/2"-13 x 4-1/4" Hex Head Bolt, Grade 8. YZP.....	4
4.....	202-0267	1/2"-13 Whiz Flange Nut, Grade 8, ZP	4
5.....	203-0005	1/2" Flat Washer	4
6.....	290-0275	8" Nylon Cable Tie	1

Important:

Use only genuine factory replacement parts on your hitch receiver. Do **NOT** substitute homemade or non-typical parts. If a bolt is lost or in need of replacement, for your safety and the preservation of your hitch receiver, be sure to use a replacement bolt of the same grade (In most cases it will be Grade 8, please reference the parts list above). Replacement parts may be ordered through your nearest Blue Ox® Dealer or Distributor. Failing to follow and/or altering these installation instructions in either installation or required equipment will void the manufacturer's warranty.

BXH1002
2021-2024 Ford Bronco
Installation Instructions

Vehicles with Trailer Wiring and/or Rear Bracket

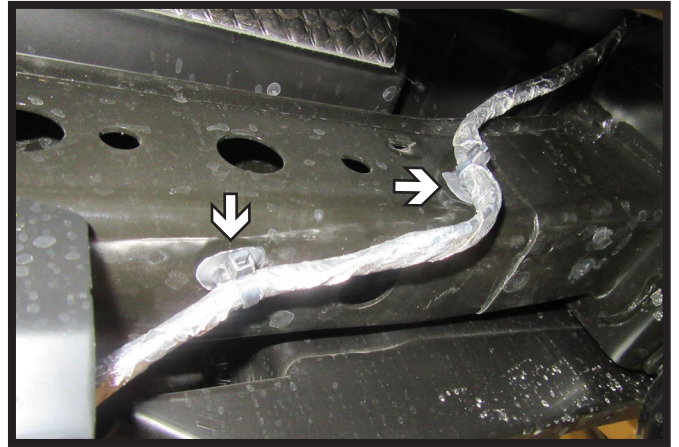
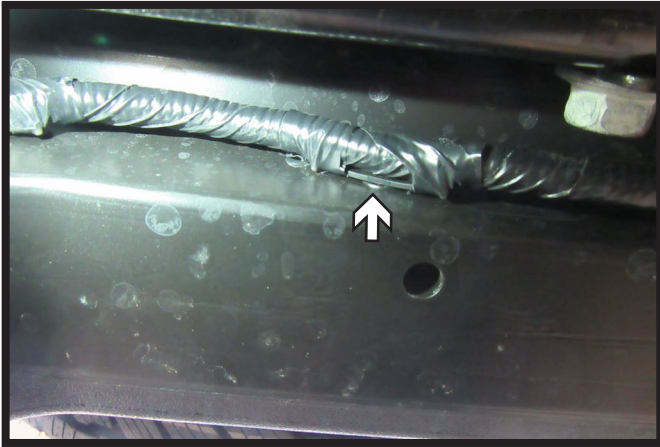

1. Unclip the wiring loom from the bumper and frame on the driver side of the vehicle. Let hang.



2. Unclip and remove electrical plug from bracket. Let hang.



3. Unplug wire harness on passenger side of the vehicle.

BXH1002
2021-2024 Ford Bronco
Installation Instructions

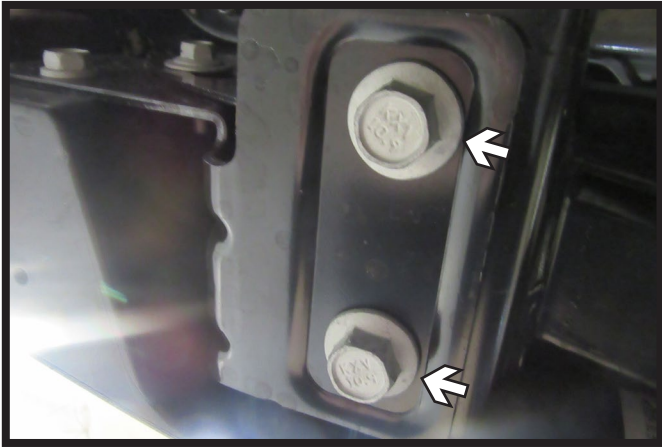

4. Using a 18MM socket, remove the two (2) bolts from behind the bumper. Do this on both sides of the vehicle.



5. Using a 13MM socket, remove the one (1) bolt from the back of the bumper on the driver side of the vehicle. Then loosen the same bolt on the passenger side of the vehicle. Open rear door and pull bumper away from the vehicle slightly.



6. Using a 18MM socket, remove the two (2) bolts from the rear bracket behind the bumper. Remove bracket, it will not be reinstalled.

BXH1002
2021-2024 Ford Bronco
Installation Instructions

Receiver Hitch Installation

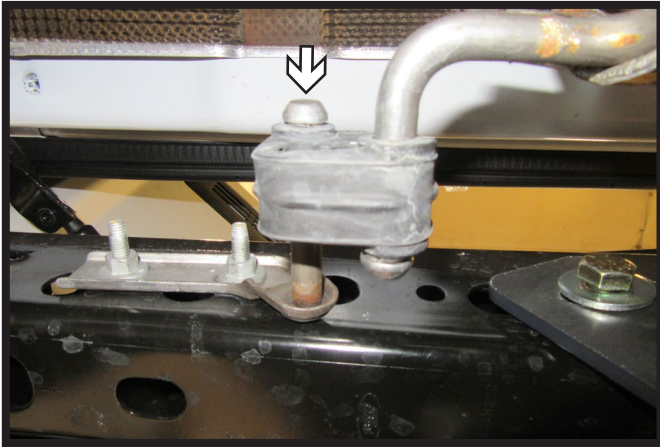

1. Remove rubber isolator from exhaust rod on each side of the vehicle. Lower exhaust.
Note: This can be done using Exhaust Hanger Removal Pliers or a 5/8" Open End Wrench.

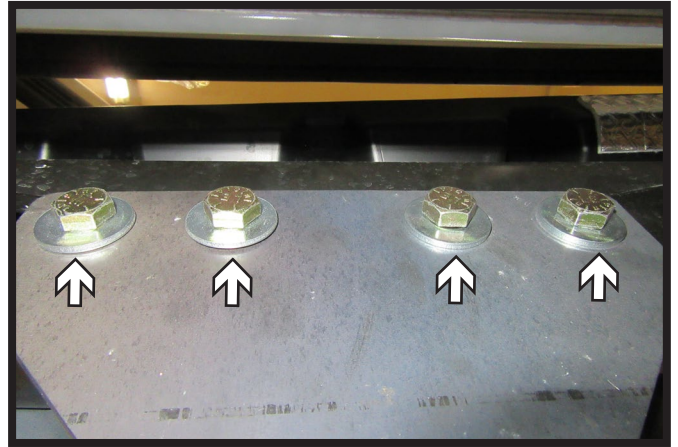

2. Raise receiver hitch into place around the bumper bar. Install the four (4) 1/2" bolts with flat washers and whiz nuts. Loosely tighten with 3/4" socket and wrench.

**** Use torque wrench to tighten all bolts to 119 ft/lbs. ****

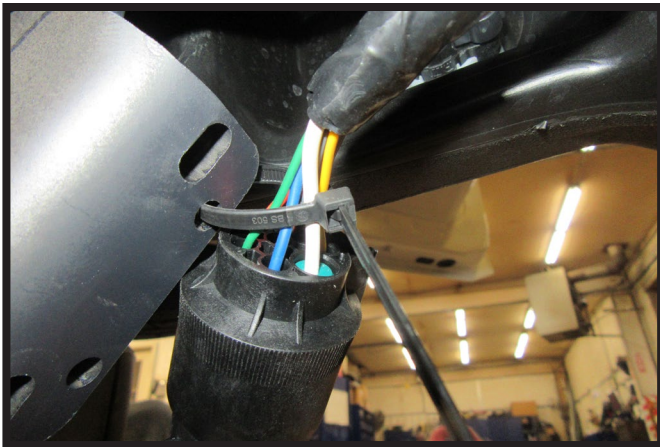

3. If present, zip tie electrical plug to passenger side of the receiver hitch as shown.



4. Reinstall exhaust and bumper if needed.

General Information

1. Ensure that your product(s) are registered online at www.blueox.com. It is crucial to register your product(s) so that you may be alerted of product offerings, updates, upgrades, maintenance and safety bulletins, and/or recalls.
2. **It is the owner's responsibility to inspect all towing equipment for cracked welds, missing or worn parts and loose bolts before each towing trip.** Be sure to tighten all bolts to the recommended specifications.
3. **It is the owner's responsibility to hook up all towing equipment per manufacturer's instructions/recommendations.**

Notice To Receiver Hitch Installer

1. **It is YOUR responsibility to watch for:**

- Electrical wires and hoses
- Missing parts or attaching points on the frame

** If the hitch receiver is improperly installed and is against a wire or hose, it could cause fluid leaks or electrical shorts some time after the actual hitch installation.

CUSTOMER SERVICE COMMITMENT

Blue Ox® is committed to providing you with exceptional customer care throughout your lifetime with our products. Our team is here to assist you with any questions you may have regarding the performance of your product. Simply call (402) 385-3051 and you can speak with our customer service team.

Additionally, please visit our website to see which rallies our team will be attending. For a nominal fee, our service technician will service your towing system to ensure it's in proper working condition. Also, as a commitment to our customers, should you visit our factory, you can stay at our full service Blue Ox® campground at no charge along with enjoying a factory tour.

Again, thank you for being our customer and for the confidence you have shown in the performance of our products. It is because of customers like you we enjoy the success we have today.

BLUE OX ORIGINAL PURCHASERS LIMITED LIFETIME WARRANTY

Automatic Equipment Manufacturing Company ("Automatic") warrants to the original (first) retail purchaser that this product, manufactured by Automatic, shall be free from defect in material and workmanship under normal use and service for as long as the original retail purchaser owns the product.

During said period, Automatic will repair or replace any parts that have been returned by the original purchaser, to the factory, transportation prepaid, and in Automatic's sole and absolute opinion found to be defective.

Limitations on Warranty Coverage:

Coverage under this warranty will be valid only if the customer warranty card is returned by the original purchaser within 30 days of purchase.

Coverage under this warranty will be effective only when a copy of the original invoice, showing date and place of purchase, accompanies any claim for warranty. This warranty is NON TRANSFERABLE.

This limited warranty will not cover, in any way or form, any alleged damages caused by incorrect or improper installation, improper use, modification or neglect of product, failure to properly service and maintain, misuse, act of God, accident or failure of the user to follow guidelines contained in the instructional material provided by Automatic.

This warranty does not cover normal wear and tear, paint or rust.

Warrantor assumes no responsibility to the owner for loss of use of product, loss of time, inconvenience or any other damage consequential or otherwise. Including, but not limited to mileage, expense of transporting of product, return shipping expense, mechanics travel time, telephone, road service, towing, and rental during repairs, travel, lodging, loss or damage to personal property or loss of earnings.

REPAIR OR REPLACEMENT AS SET FORTH IN THIS LIMITED WARRANTY IS THE SOLE EXCLUSIVE REMEDY OF THE PURCHASER. AUTOMATIC SHALL NOT BE LIABLE FOR ANY INCIDENTAL OR CONSEQUENTIAL DAMAGES FOR BREACH OF ANY EXPRESS OR IMPLIED WARRANTY ON THIS PRODUCT. EXCEPT TO THE EXTENT PROHIBITED BY APPLICABLE LAW, ANY IMPLIED WARRANTY OF MERCHANTABILITY OR FITNESS FOR A PARTICULAR PURPOSE ON THIS PRODUCT IS LIMITED IN LENGTH TO THE DURATION OF THIS WARRANTY.

Please visit <http://blueox.com/warranty/> to register your warranty

