



Baseplate Installation Instructions

# BX3830 2010-12 VW Jetta Wagon Installation Instructions

Serial Number

**Please read BOTH these Installation Instructions and the General Instructions before attempting to install or operate this equipment.**

- Blue Ox® towing products and accessories are intended to be installed by Blue Ox® Dealers who are familiar with our products and have the equipment necessary and knowledge to do "fit work". When necessary Blue Ox® Dealers can be found at [www.blueox.com](http://www.blueox.com) or by contacting our Customer Care Department at (402) 385-3051.
- Many Blue Ox® Baseplates are designed to use existing holes and hardware to mount the baseplate to the towed vehicle. Even though bolts are there, do not assume they are adequate for baseplate mounting. Always use hardware supplied in the hardware kit and existing hardware specified in the Baseplate Installation Instructions.

Attachment Tab Height: 13.5"

Attachment Tab Width: 20"

**Bolt Torque Specifications**  
Torque in Foot-Pounds for Metric Bolts

Bolt Size	Grade 8.8	Grade 10.9
6MM	6	8
8MM	16	22
10MM	31	40
12MM	54	70
14MM	89	117

Confirm the and pre-towing procedures for your vehicle with the owner's manual or contact the vehicle's manufacturer for specific towing procedures.

**Bolt Torque Specifications**  
Torque in Foot-Pounds for Inch Bolts

Bolt Size	Grade 5	Grade 8
1/4"	10	14
5/16"	19	29
3/8"	33	47
7/16"	54	78
1/2"	78	119
5/8"	154	230



**If the front of your vehicle looks different than this, call us at (888) 425-5382.**

**! WARNING**  
Failure to read and follow these instructions could result in separation of the towed vehicle from the tow bar, causing property damage, loss of towed vehicle, personal injury or death.

# BX3830

## 2010-12 VW Jetta Wagon

### Installation Instructions

### Parts List

Ref. No.	Qty.	Part #	Description
1	1	61-6784	Weldment, Baseplate, BX3830
2	8	61-5208	Weldment, 3/8-16 Nutplate, w/ 14" Wire
3	8	201-0440	3/8-16 X 1 1/2 Hex Bolt, Grd.5, ZP
4	8	203-0010	3/8 Lock Washer, ZP
5	1	201-0702	6MM-1.00 X 45MM Hex Bolt, Grd 8.8,
6	1	203-0161	6MM, Lock Washer, ZP
7	7	203-0002	5/16 Flat Washer, ZP
8	2	201-0979	#12-14 x 1" Self Drilling Screw, ZP
9	2	201-0192	#10-32 x 1/2" Slot Rd. Hd. Screw
10	2	203-0054	#10 Lock Washer
11	2	202-0047	#10-32 Hex Nut
12	2	101-5822	Adapter, 4 Way Connector
13	2	62-3468	Attachment. Assembly, SF/SB (R)
	2	226-0046	Baseplate Safety Cable, 36" CL III (Not Shown)
	2	229-0359	Quicklink, 3/8, ZP (Not Shown)
	2	290-0437	Cap Plug, Black (Not Shown)

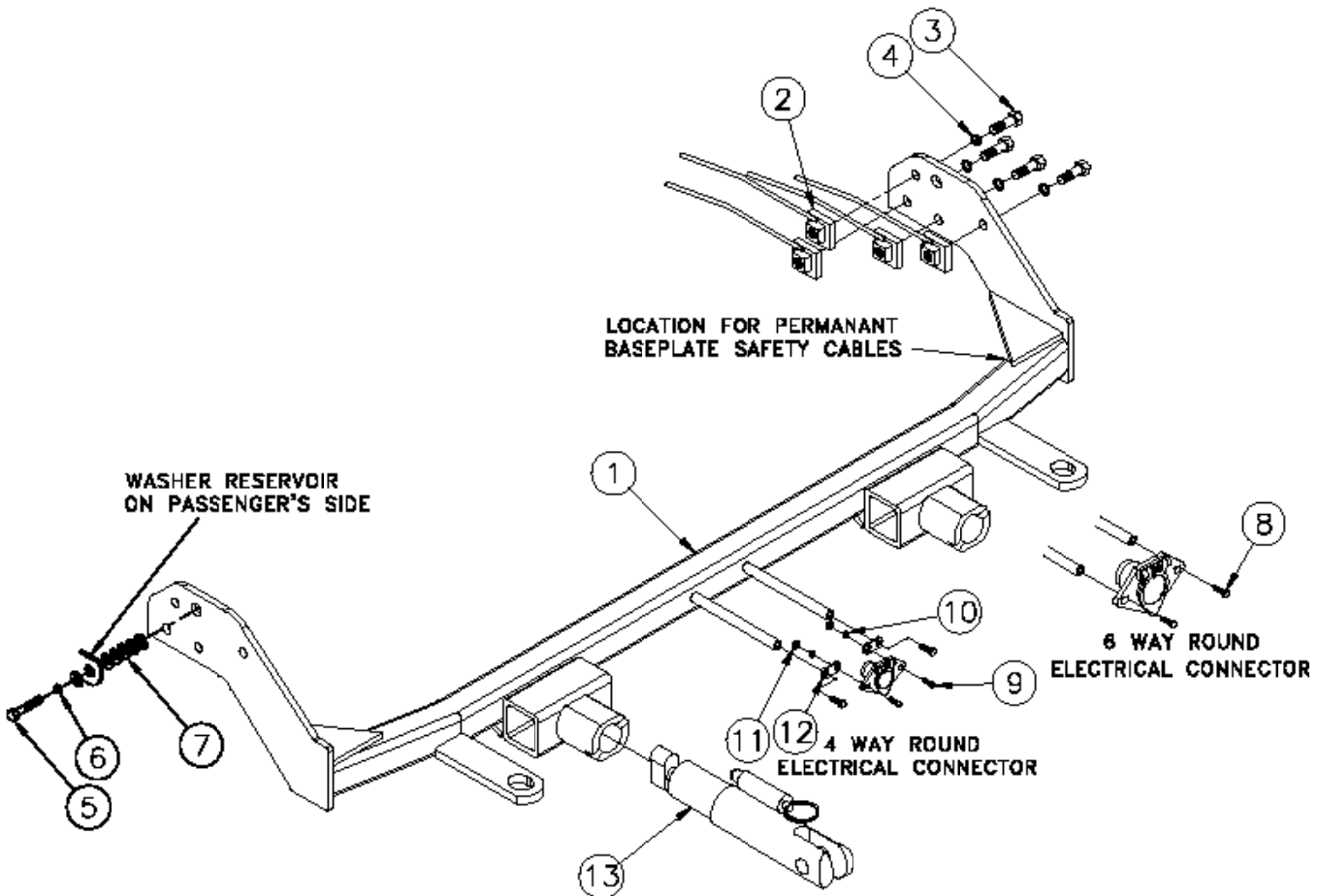

### Important:

Use only genuine factory replacement parts on your baseplate. Do **NOT** substitute homemade or non-typical parts. If a bolt is lost or in need of replacement, for your safety and the preservation of your baseplate, be sure to use a replacement bolt of the same grade (In most cases it will be Grade 5, please reference the parts list above). Replacement parts may be ordered through your nearest Blue Ox® Dealer or Distributor, or call our Customer Care Team at (402)385-3051. Failing to follow and/or altering these installation instructions in either installation or required equipment will void the manufacturer's warranty. Towing behind a non-motorized vehicle will void the warranty.

# BX3830

## 2010-12 VW Jetta Wagon

### Installation Instructions

#### Attachment Tabs:

Motorhome mount tow bars are recommended for use with this baseplate. Due to the design of the removable tabs, the RangeFinder II, Adventurer and Ambassador tow bars can not be used. The Acclaim tow bar may be used, but will not fold and store on the front of the vehicle. Adapters, except for the BX8833 and the BX88151, can not be used with this baseplate.

#### Instructions:

The upper grille, front fascia, metal bumper and windshield washer reservoir are removed and reinstalled. Trimming of metal bumper and webbing on frame end is required. Drilling is required.

The dimensional variations between otherwise identical vehicles can be considerable. While the baseplate was designed for easy installation, it may be necessary to tailor the baseplate slightly to compensate for auto manufacturer's tolerances. These minor adjustments may include filing a hole slightly, bending electrical rods or bending end plates.

The BX8869 Bulb & Socket Wiring Kit is recommended for this vehicle.



Possible Location for the BX8869 Bulb and Socket Wiring Kit.

#### Installation Instructions:



1. Using the 25 Torx socket, remove the two metric bolts from the top edge of the fascia. Do this on both sides of the vehicle. Set bolts aside to be reinstalled later.



2. Grasp the top of the grille, pull forward and it will release. Set the grille aside to be reinstalled later.

Handling of some cosmetic parts when installing this product may require the use of protective covers, rags, specialty tools, etc. to prevent damage.

BX3830  
2010-12 VW Jetta Wagon  
Installation Instructions

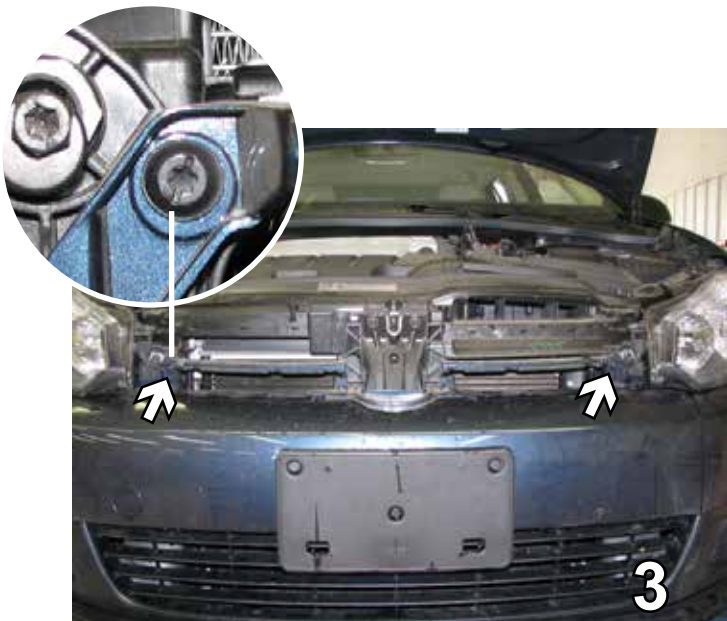

3. Using the 25 Torx socket, remove the two metric bolts from the lower grille, one on each side. Set bolts aside to be reinstalled later.

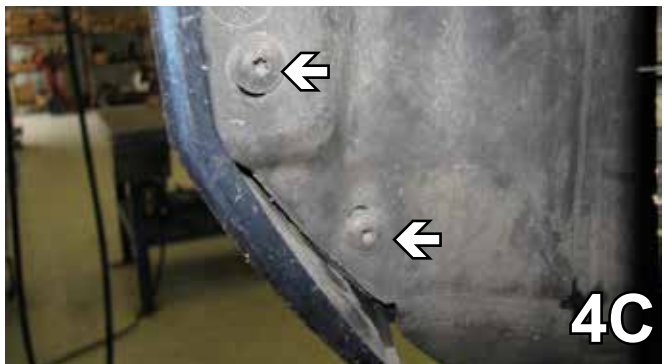
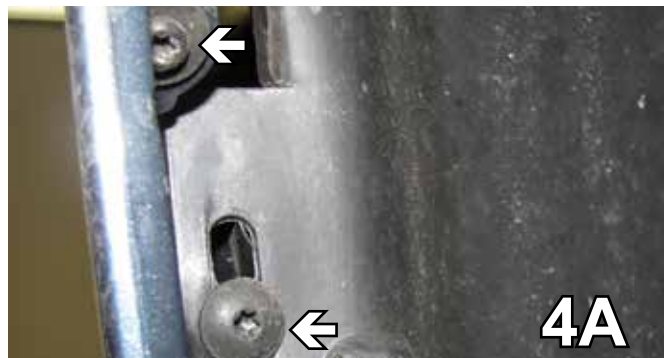

4. Using the 25 Torx socket, remove the five metric bolts just forward of the front tire on the edge of the wheel well, Do this on both sides of the vehicle. Set bolts aside to be reinstalled later.



6. Using the the 25 Torx socket, remove the four metric bolts from the lower edge of the fascia. Do this on both sides of the vehicle. Set bolts aside to be reinstalled later.

BX3830  
2010-12 VW Jetta Wagon  
Installation Instructions



6. Remove the styrofoam bumper. Using the 30 Torx socket, remove the two bolts above the middle of the metal bumper. Set bolts aside to be reinstalled later.



7. Remove the temperature sensor by sliding a screwdriver under the clip as shown by the white arrow. Pull the sensor straight down. Set sensor aside to be reinstalled later.

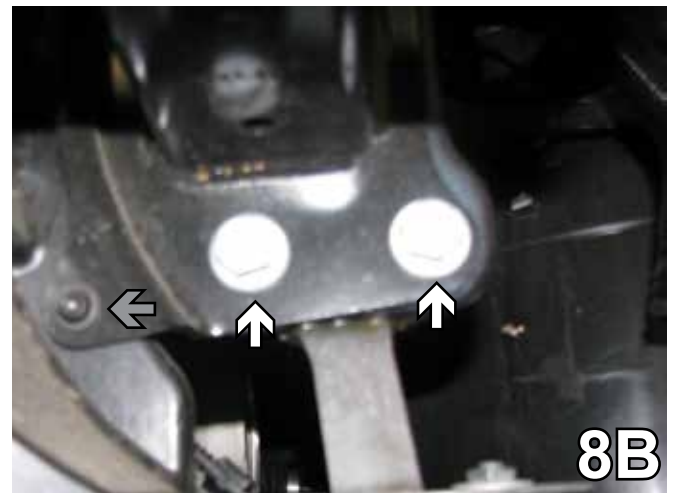
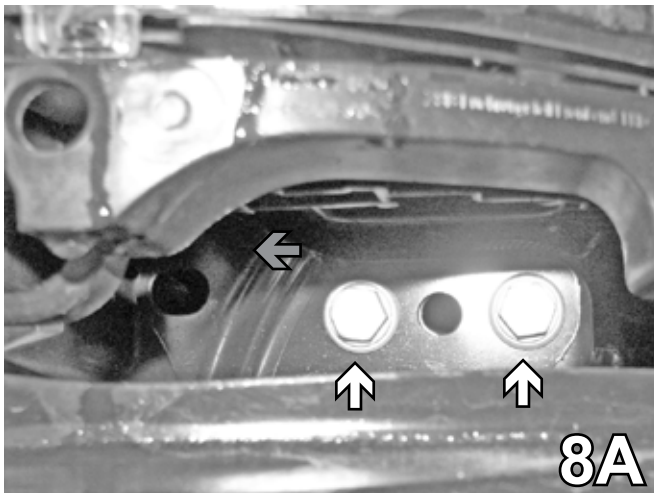

8. Above the metal bumper (8A), using the 16MM socket remove the two metric hex bolts (white arrows). Using the 30 Torx socket, remove the Torx bolt (gray arrow). Below the metal bumper (8B), using the 16MM socket remove the two metric hex bolts (white arrows). Using the 30 Torx socket, remove the Torx bolt (gray arrow). Do this on both sides of the vehicle. Pull the bumper forward and set it and the bolts aside to reinstall later.

BX3830  
2010-12 VW Jetta Wagon  
Installation Instructions

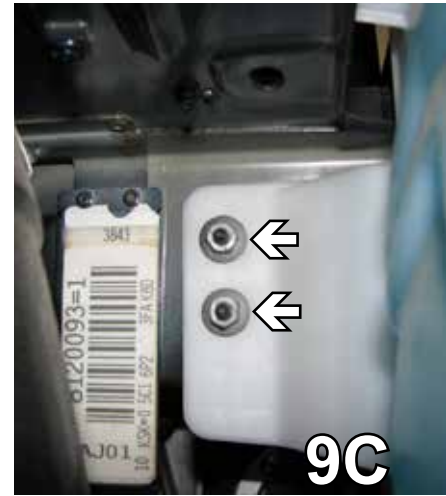
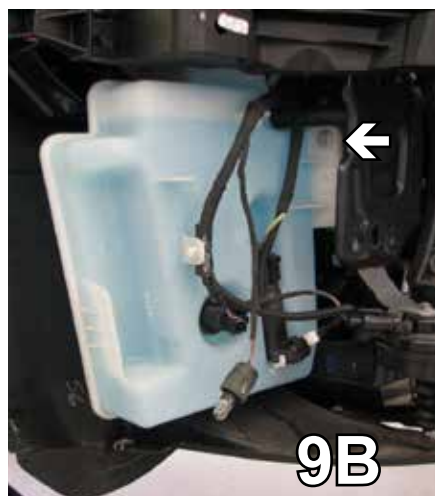

9. On the passenger's side, using the 10MM socket, remove the metric bolt from the washer reservoir spout (9A). Using the 10MM socket, remove the front metric bolt from the reservoir (9B). Remove the two metric hex nuts between the wheel well and the reservoir (9C). Disconnect all the electrical and fluid lines, plug the reservoir port. Pull the bottom of the reservoir away from the frame to clear the back studs, then pull the reservoir down. Set the reservoir, bolts and nuts aside to reinstall later.

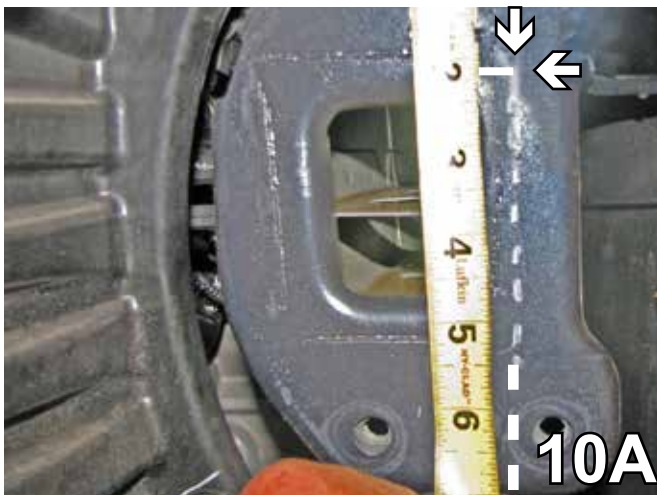

10. Measure from the top edge of the frame end down and mark 2" down on the side of the frame webbing. Using the reciprocating saw, cut the webbing to the side of the frame rail and make a vertical cut flush with the side of the frame straight down to the end. Remove this area on both sides of the vehicle to prepare for the base plate installation. **Using a good quality spray paint, coat the cut edges to prevent corrosion.** Do this on both sides of the vehicle.

BX3830  
2010-12 VW Jetta Wagon  
Installation Instructions

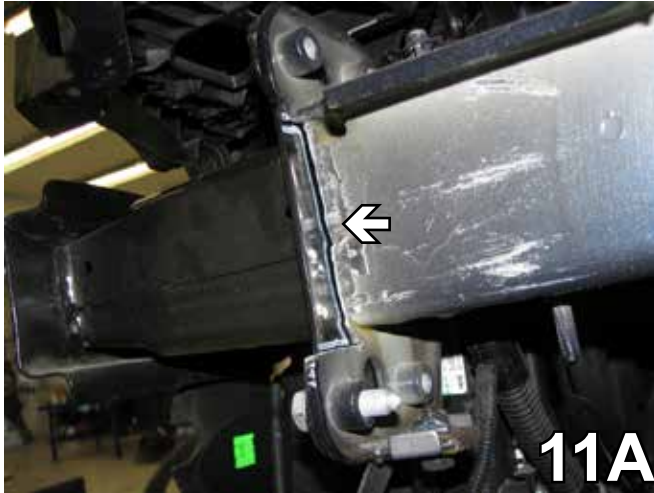

11. Reinstall the metal bumper using one metric hex bolt. Do this on both sides. (Adjust the height of the metal bumper to its original position). Mark the back side of the webbing where the frame webbing was removed. Remove the bumper, cut with the reciprocating saw and remove this area. Do this on both sides. **Using a good quality spray paint, coat the cut edges to prevent corrosion.**



12. Reinstall the metal bumper to its original height, measure 1 3/4" from the end of the metal bumper and remove this lower area with the reciprocating saw. Do this on both sides.

13. Using the 12MM socket, remove the metric bolt from the horn bracket. Unplug the electrical connections, set the horn and bracket aside. Do this on both sides of the vehicle.



14. Using the 1 1/4" hole saw, cut a hole on the front of the metal bumper just forward of the center of the frame end. Do this on both sides of the vehicle. This will allow access to the inside of the frame end to insert the nut plates for the base plate installation.

# BX3830

## 2010-12 VW Jetta Wagon

### Installation Instructions



15. Move the hose and mark the air dam just below the metal bumper. Using a utility knife, cut and remove that portion. Do this on both sides of the vehicle.

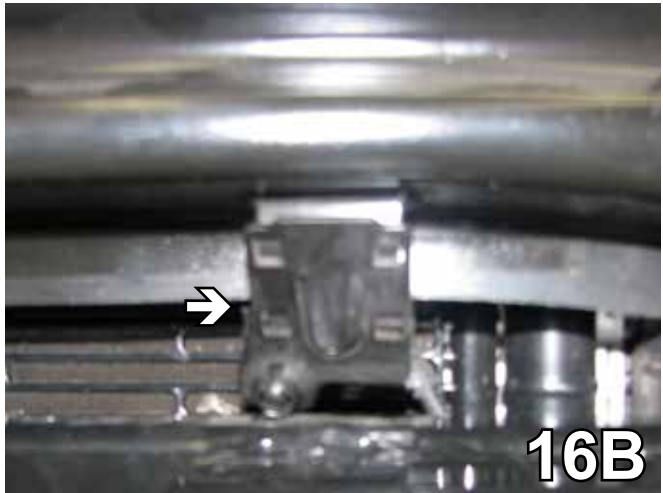

16. Cut the side piece off of the air temperature sensor (16A). Bend the metal piece back and snap the sensor into place (16B). This will prepare the area for the base plate installation.



17. Slide the base plate onto the side of the frame with the attachment tabs down. Push the base plate back toward the rear of the vehicle while lifting the cross tube up. The bottom edge of the end plate should be even with the bottom edge of the frame. Align the top center hole with the existing bolt location for the front of the washer reservoir on the passenger's side, clamp to the frame with vise grips.

When using power drills be aware of the dangers of torque and drill bit length.



18. Using the baseplate as a template, drill the holes in the side of the frame rail with the 13/32" drill bit. Do this on both sides of the vehicle.



# BX3830

## 2010-12 VW Jetta Wagon

### Installation Instructions



19. Insert the nut plate into the drilled hole on the front of the bumper to align with the drilled holes in the frame. Tighten the 3/8" bolts and lock washers on both sides. Keep the base plate attachment tabs level with the vehicle. **Be sure to use Loctite red on all the bolts before tightening. Tighten all the bolts according to Torque Chart in the General Instruction Sheet.**



20. Using the hammer, tap the webbing toward the back of the vehicle 3/8", just behind the washer reservoir, on the passenger's side. This will prepare the area for reinstallation of the washer reservoir.

**\*\*BE SURE TO USE LOCTITE® RED ON ALL BOLTS BEFORE TIGHTENING. TIGHTEN ALL BOLTS ACCORDING TO THE TORQUE CHART ON PAGE 1 OF THESE INSTRUCTIONS OR ON PAGE 3 OF THE BASEPLATE TOWING GENERAL INSTRUCTIONS.**

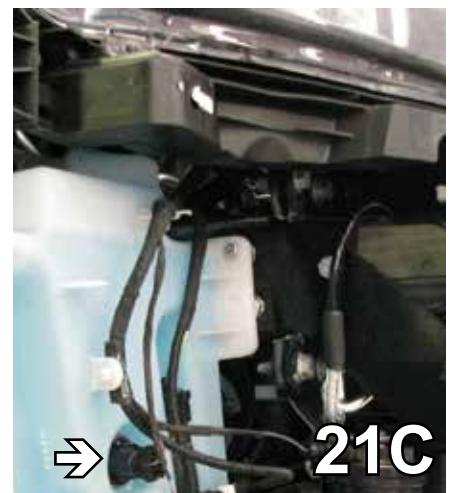
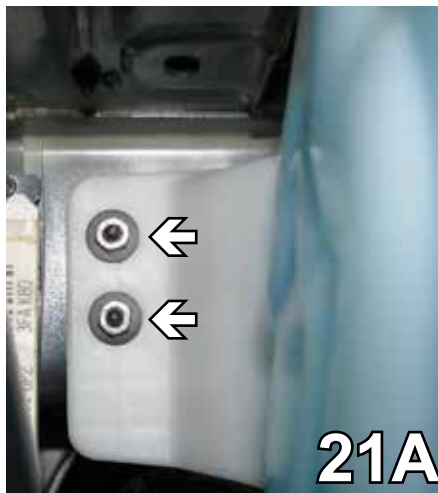

21. Put the washer reservoir in place on the back two studs (21A) and install the two hex nuts (Do not tighten). Replace the front metric bolt with the 6MM hex bolt provided. Install flat washers and lock washer provided (21B). **Be sure that the webbing does not touch on the back side of the reservoir. This will prevent webbing from rubbing a hole in the reservoir tank (21A).** Reconnect all the electrical and fluid lines to the reservoir (21C).

# BX3830

## 2010-12 VW Jetta Wagon

### Installation Instructions



22. Attach the permanent baseplate safety cables to the provided convenience link on the baseplate (see grey arrow). The photo above shows the recommended installation of the cables to frame of vehicle (see white arrow). Additional options may interfere with suggested mounting; in this case secure the cables to a solid piece of the frame as described in the instructions included with the permanent baseplate safety cables. Be sure the safety cables do not rub against any hoses or moving parts. Do this to both sides of the vehicle.



23. Reinstall both horns and their brackets. Reinstall the styrofoam on the front of the metal bumper.

**Be sure that ALL electrical connections are plugged in properly and functioning BEFORE installing the fascia.**



24. Hold the fascia to its original position and carefully cut the lower grille with a utility knife or a hack saw blade, to allow attachment receivers to come through. Do this on both sides. Reinstall the fascia. The installation of the baseplate is complete.

25. The dimensional variations between otherwise identical cars can be considerable. While the baseplate was designed for easy installation, it may be necessary to tailor the baseplate slightly to compensate for auto manufacturers' tolerances. These minor adjustments may include filing a hole slightly, bending electrical rods, adding shims and/or bending endplates.

26. Install the tow bar and safety cables according to the instructions included in their packages. When demonstrating this to the customer. Be sure to include all the contents and packages.

27. Do **NOT** substitute other devices if the tow bar pins and clips are misplaced.

# BX3830 2010-12 VW Jetta Wagon Installation Instructions

## **DEALER or INSTALLER:**

**Be certain the user receives the instruction sheets for their products.**



If the baseplate is in an accident, it must be replaced. DO NOT use it again! An accident can cause unseen damage and using it again could result in more damage or serious injury. DO NOT use the baseplate if it is damaged or missing parts.

## **CUSTOMER SERVICE COMMITMENT**

Blue Ox is committed to providing you with exceptional customer care throughout your lifetime with our products. Our team is here to assist you with any questions you may have regarding the performance of your product. Simply call 1-(402) 385-3051 and you can speak with our customer care team.

Additionally, please visit our website to see which rallies our Destination America team will be attending. For a nominal fee, our service technician will service your towing system to ensure it's in proper working condition. Also as a commitment to our customers, should you visit our factory you can stay at our full service Blue Ox campground at no charge along with enjoying a factory tour.

Again thank you for being our customer and for the confidence you have shown in the performance of our products. It is because of customers like you we enjoy the success we have today.



© 2010 Blue Ox  
One Mill Road, Industrial Park  
Pender, Nebraska 68047  
Phone: (402) 385-3051  
Toll Free: (888) 425-5382  
Fax: (402) 385-3360  
[www.blueox.com](http://www.blueox.com)

# General Information

1. Ensure that your product(s) are registered online at [www.blueox.com](http://www.blueox.com). It is crucial to register your product(s) so that you may be alerted of product offerings, updates, upgrades, maintenance and safety bulletins, and/or recalls.
2. **It is the owner's responsibility to inspect all towing equipment for cracked welds, missing or worn parts and loose bolts before each towing trip.** Be sure to use Loctite® Red on all bolts and tighten to the recommended specifications.
3. **It is the owner's responsibility to hook up all towing equipment per manufacturer's instructions/recommendations.**
4. Remove the attachment tabs when not in use (if applicable).

## Notice To Baseplate Installer

### 1. It is YOUR responsibility to watch for:

- Oil cooler and air conditioner lines
- Electrical wires and hoses
- Missing parts or attaching points on the frame

\*\* If the baseplate is improperly installed and is against a wire or hose, it could cause fluid leaks or electrical shorts some time after the actual baseplate installation.

## Permanent Baseplate Safety Cable Installation

Permanent baseplate safety cables are strongly recommended when towing a vehicle with a tow bar. The principle function of the permanent baseplate safety cables is to prevent the towed vehicle from breaking loose in the event the connection between the frame of the towed vehicle and the baseplate fails or becomes disconnected. The cables must be connected from the baseplate to the frame rail or cross member of the vehicle's frame. The illustrations below show the possible arrangements recommended by Blue Ox®. Each permanent baseplate safety cable must have an adequate weight rating for the towing system. The weight rating of the two (2) cables together will not qualify.

***Do not mount the permanent baseplate safety cables against wires, hoses or brake lines.***

These permanent baseplate safety cables should remain installed as long as the baseplate is installed on the vehicle. Permanent baseplate safety cables are to be used in conjunction with, and NOT a replacement for legally required safety cables attaching the towed vehicle to the towing vehicle.

### OPTION #1

Permanent Baseplate Safety Cables to Cross Member or Frame of Towed Vehicle.

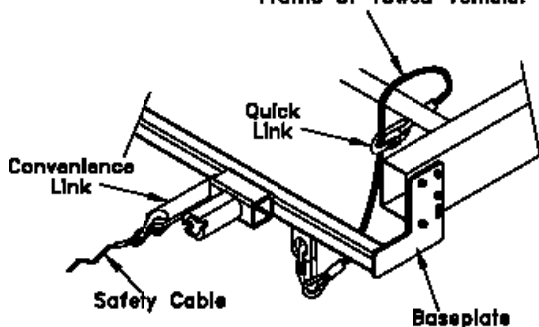

### OPTION #2

Permanent Baseplate Safety Cables to Cross Member or Frame of Towed Vehicle.

