



BX3827

2000-05 VW Jetta TDI Installation Instructions

Serial Number

Please read BOTH these Installation Instructions and the General Instructions before attempting to install or operate this equipment.

- Blue Ox® towing products and accessories are intended to be installed by Blue Ox® Dealers who are familiar with our products and have the equipment necessary and knowledge to do "fit work". When necessary Blue Ox® Dealers can be found at www.blueox.com or by contacting our Customer Care Department at (402) 385-3051.
- Many Blue Ox® Baseplates are designed to use existing holes and hardware to mount the baseplate to the towed vehicle. Even though bolts are there, do not assume they are adequate for baseplate mounting. Always use hardware supplied in the hardware kit and existing hardware specified in the Baseplate Installation Instructions.

Attachment Tab Height: 12"
Attachment Tab Width: 18-1/2"

Bolt Torque Specifications
Torque in Foot-Pounds for Metric Bolts

Bolt Size	Grade 8.8	Grade 10.9
6MM	6	8
8MM	16	22
10MM	31	40
12MM	54	70
14MM	89	117

Confirm the and pre-towing procedures for your vehicle with the owner's manual or contact the vehicle's manufacturer for specific towing procedures.

Bolt Torque Specifications
Torque in Foot-Pounds for Inch Bolts

Bolt Size	Grade 5	Grade 8
1/4"	10	14
5/16"	19	29
3/8"	33	47
7/16"	54	78
1/2"	78	119
5/8"	154	230



If the front of your vehicle looks different than this, call us at (402) 385-3051.

! WARNING

Failure to read and follow these instructions could result in separation of the towed vehicle from the tow bar, causing property damage, loss of towed vehicle, personal injury or death.

BX3827
2000-05 VW Jetta TDI
Installation Instructions

Parts List

Ref. No.	Qty.	Part #	Description
1	1	61-6497	WLDM'T, BASEPLATE, BX3827
2	1	101-7192	HORN BRACKET, BX3827
3	9	61-5208	WLDT, NUT PLT, 1/4X1X1, 3/8 BLT WIR
4	1	201-0368	3/8-16 X 1 1/4 HEX HEAD BOLT,GRD. 5
5	8	201-0440	3/8-16 X 1 1/2 HEX BOLT, GRD.5, ZP
6	9	203-0010	3/8 LOCK WASHER, ZP
7	2	201-0979	#12-14 x 1" Self Drilling Screw, ZP
8	2	201-0192	10-32 X 1/2 SLOT, RD. HD. SCREW
9	2	203-0054	#10 LOCK WASHER
10	2	202-0047	#10-32 HEX NUT
11	2	101-5822	ADAPTER, 4 WAY CONNECTOR
12	2	62-3469	ATT TAB ASSY, REM, SF/LB, 1 HOLE
	2	226-0046	BASEPLATE SAFETY CABLE, 36" CL III (Not Shown)
	2	229-0359	QUICKLINK, 3/8, ZP (Not Shown)
	2	290-0437	RECEIVER, CAP PLUG (BLK) (Not Shown)

Tools Required

T-25 Torx Socket	T-30 Torx Socket
10MM Socket	13MM Socket
9/16" Socket	Sm Flat Screwdriver
13/32" Drill Bit	Reciprocating Saw
Loctite Red	Utility Knife

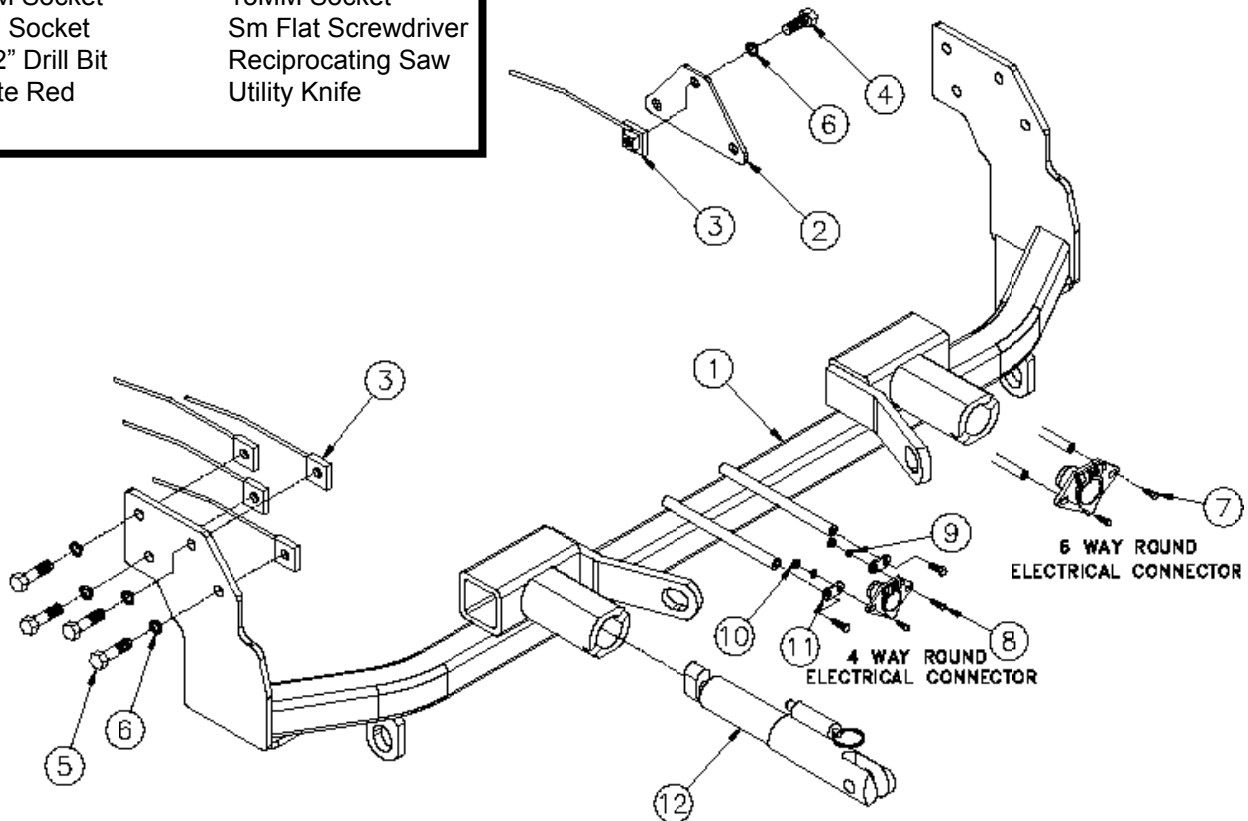

Important:

Use only genuine factory replacement parts on your baseplate. Do **NOT** substitute homemade or non-typical parts. If a bolt is lost or in need of replacement, for your safety and the preservation of your baseplate, be sure to use a replacement bolt of the same grade (In most cases it will be Grade 5, please reference the parts list above). Replacement parts may be ordered through your nearest Blue Ox® Dealer or Distributor, or call our Customer Care Team at (402)385-3051. Failing to follow and/or altering these installation instructions in either installation or required equipment will void the manufacturer's warranty. Towing behind a non-motorized vehicle will void the warranty.

BX3827
2000-05 VW Jetta TDI
Installation Instructions

Attachment Tabs:

Motorhome mount tow bars are recommended for use with this baseplate. Due to the design of the removable tabs, the RangeFinder II, Adventurer and Ambassador tow bars can not be used. The Acclaim tow bar may be used, but will not fold and store on the front of the vehicle. Adapters, except for the BX8833 and the BX88151, can not be used with this baseplate.

Instructions:

The grille, front fascia, hood latch, horn bracket, turbo cooler, air dam, and metal bumper are removed and reinstalled.

Trimming of frame, air dam and grille is required. Drilling is required.

The dimensional variations between otherwise identical vehicles can be considerable. While the baseplate was designed for easy installation, it may be necessary to tailor the baseplate slightly to compensate for auto manufacturer's tolerances. These minor adjustments may include filing a hole slightly, bending electrical rods or bending end plates.

The BX8869 Bulb and Socket Wiring Kit is recommended for this vehicle.



Possible location for the BX8869 Bulb and Socket Wiring Kit.

Installation Instructions

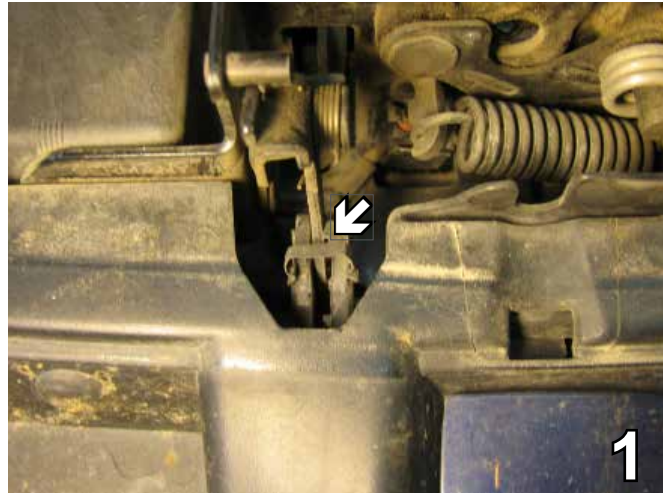

1. Open hood and remove the hood latch pin fastening the plastic handle to latching mechanism, set handle aside.



2. Pull the center of the grille forward to release it from the bumper fascia. Set grille aside.

Handling of some cosmetic parts when installing this product may require the use of protective covers, rags, specialty tools, etc. to prevent damage.

BX3827
2000-05 VW Jetta TDI
Installation Instructions



3. Using a 30 Torx, remove five (5) Torx screws which are exposed after the grille was removed. Set screws aside for later reinstallation.



4. In the wheel well, just forward the front tire, remove four (4) Torx bolts using a T-25 Torx socket. Do this to both sides and set aside for later reinstallation.



5. On the front of the fascia there is a small plastic clip (offset circle) to release the lower grille panel. Push clips up to release by using a flat screwdriver. Do to both sides. Set lower grille panels aside to be reinstalled later.

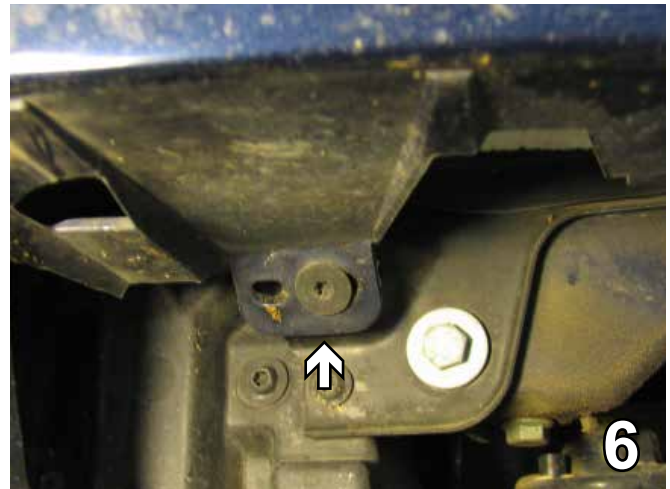

6. Just behind grille panel removed in step 5, remove torx head bolts below the bumper, using a T-25 Torx socket. Do this to both sides and set bolts aside to reinstall later. Pull fascia corners out to the side, pull fascia forward to remove. Set fascia aside carefully to reinstall later.

BX3827
2000-05 VW Jetta TDI
Installation Instructions



7. Remove two (2) bolts from the horn below the driver's side of the bumper using a 13MM socket. Unplug horn. Set the horn and bolts aside to reinstall later.



8. On the driver's side, use the reciprocating saw to cut along the lower bumper contour, as shown in the photo.

Using a good quality paint, spray cut edges of frame to prevent rusting.



9. On the passenger side, using a 10MM wrench, remove the two (2) bolts holding the turbo cooler. Tie the turbo cooler back toward the front tire out of the way.



10. To begin removing bumper, remove two (2) bolts (white arrows) with a 13MM socket, and also remove two (2) torx head bolts (gray arrows) using a 30 Torx socket. Do this to both sides and set aside to reinstall later.

BX3827
2000-05 VW Jetta TDI
Installation Instructions

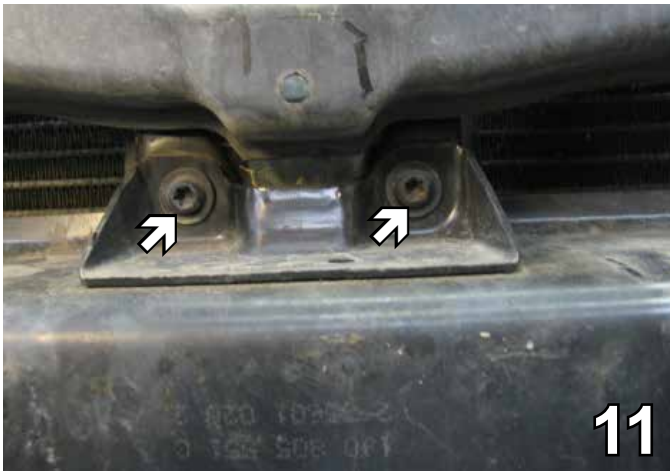

11. In the center of the metal bumper are two (2) torx bolts that need to be removed using a 25 Torx socket. Remove bolts and bumper, set aside to reinstall later.

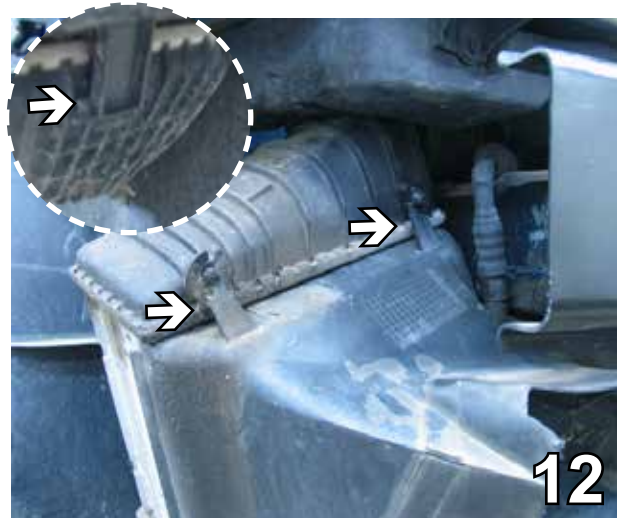

12. On the passenger side, pop the two (2) tabs on the top of the turbo cooler air dam. Slide the air dam down to release the lower clip (see inset). Trim before reinstallation.

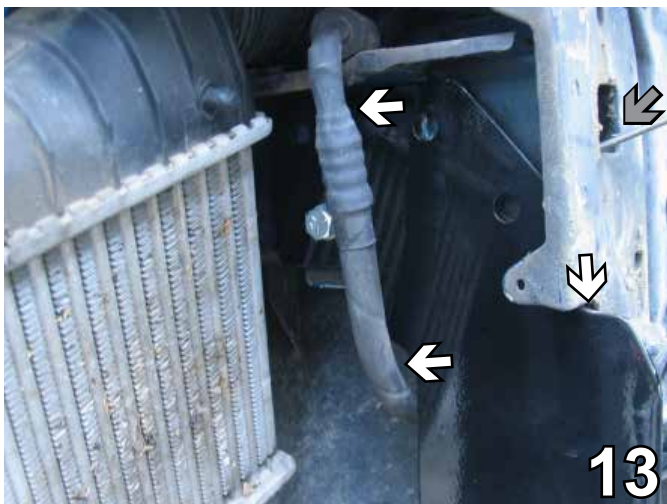

13. Tip the baseplate up and slide in over the hose on the passenger's side. Clamp the baseplate as high as possible until it hits the frame and clear forward. The nut plates will be inserted through the opening in the frame indicated with the gray arrow later.

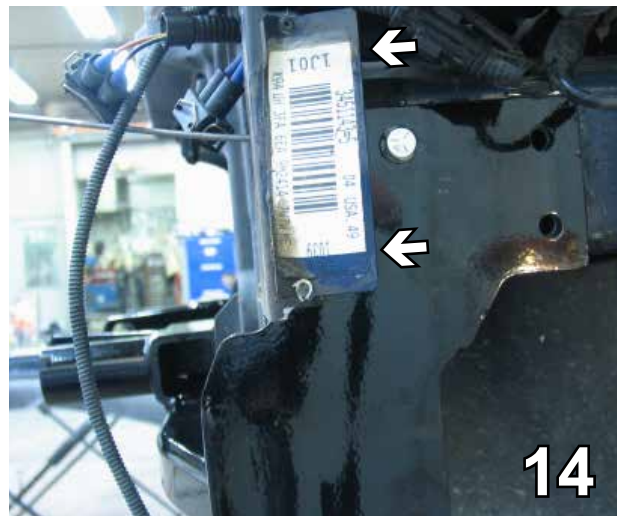

14. Using the baseplate as a template, use a 13/32" drill bit to drill all the holes. On the driver's side, bend the metal plate back before drilling, return plate to its original position when finished.

When using power drills be aware of the dangers of torque and drill bit length.

BX3827
2000-05 VW Jetta TDI
Installation Instructions



15. On the passenger side, also use the baseplate as a template and cover the 13/32" drill bit with a tube to protect the turbo cooler.

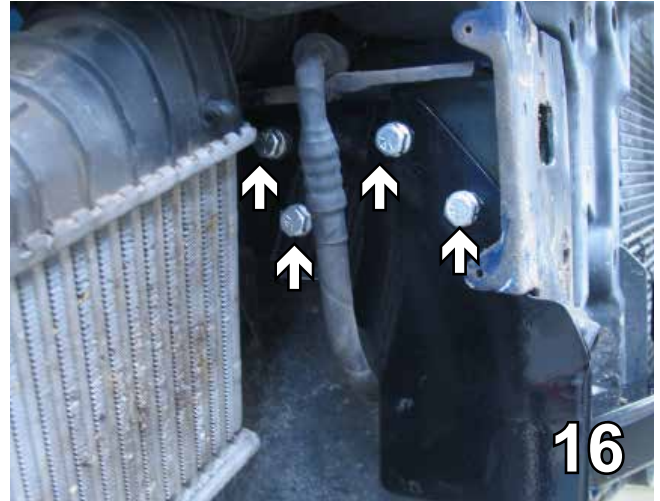

16. Install 1-1/2" bolts and 3/8" lock washers with 1" nut plates inserted into the frame end. Use Loctite Red on all the bolts and tighten. Both sides, four (4) per side.

****BE SURE TO USE LOCTITE® RED ON ALL BOLTS BEFORE TIGHTENING. TIGHTEN ALL BOLTS ACCORDING TO THE TORQUE CHART ON PAGE 1 OF THESE INSTRUCTIONS OR ON PAGE 3 OF THE BASEPLATE TOWING GENERAL INSTRUCTIONS.**

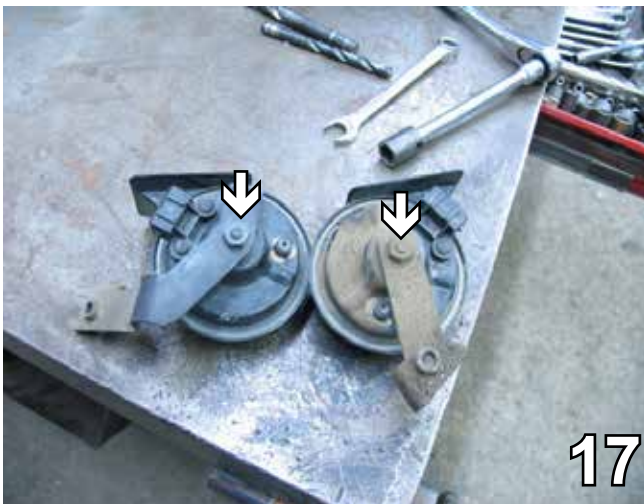

17. Using a 13MM socket, remove the existing horn brackets.

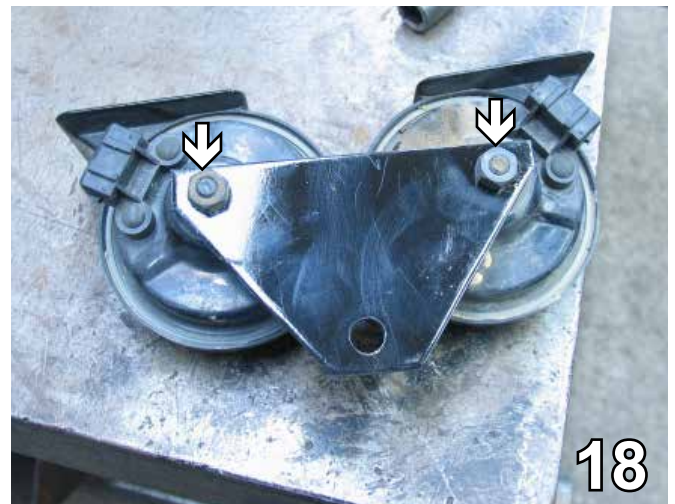

18. Attach the horns to the horn bracket provided using the existing hardware.

BX3827
2000-05 VW Jetta TDI
Installation Instructions

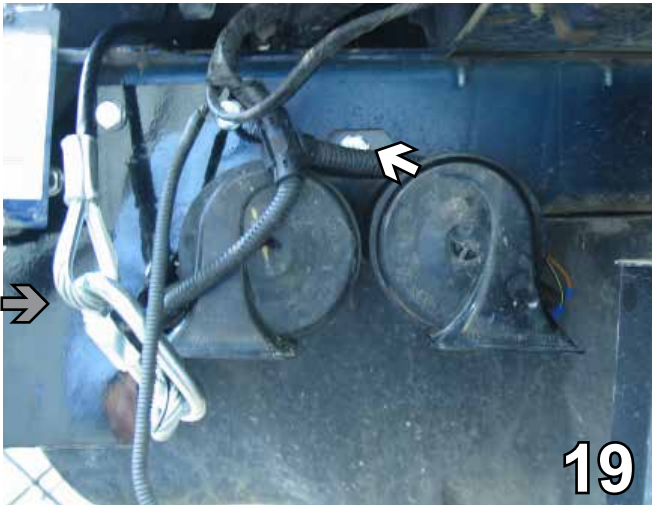

19. Reconnect wire and position the horn bracket on the driver's side just behind baseplate, drill the hole using the 13/32" drill bit. Insert 1-1/4" bolt and 3/8" lock washer with 1" nut plate. Attach baseplate safety cables (grey arrow). Position the cables around a solid piece of the frame.



21. On the passenger side, reattach the air dam and trim the cover to fit. Reattach the bumper.

20. Reattach the turbo cooler.

Be sure that ALL electrical connections are plugged in properly and functioning BEFORE installing the fascia.



22. Hold the fascia in place. Mark where the attachment tab receivers and convenience links will come through and trim as needed. Reinstall fascia, lower & upper grille panels and reattach the hood latch.

Install the tow bar and safety cables according to the instructions included in their packages.

Do not substitute other devices if the tow bar pin and clip are lost.

DEALER OR INSTALLER: BE CERTAIN THE USER RECEIVES THE INSTRUCTION SHEETS.

BX3827
2000-05 VW Jetta TDI
Installation Instructions

DEALER or INSTALLER:

Be certain the user receives the instruction sheets for their products.



Without removable tabs installed.

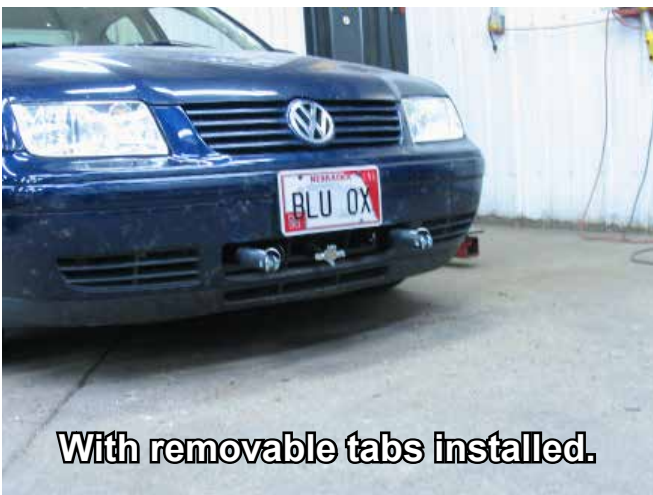

With removable tabs installed.

If the baseplate is in an accident, it must be replaced. DO NOT use it again! An accident can cause unseen damage and using it again could result in more damage or serious injury. DO NOT use the baseplate if it is damaged or missing parts.

CUSTOMER SERVICE COMMITMENT

Blue Ox is committed to providing you with exceptional customer care throughout your lifetime with our products. Our team is here to assist you with any questions you may have regarding the performance of your product. Simply call 1-800-228-9289 and you can speak with our customer care team.

Additionally, please visit our website to see which rallies our Destination America team will be attending. For a nominal fee, our service technician will service your towing system to ensure it's in proper working condition. Also as a commitment to our customers, should you visit our factory you can stay at our full service Blue Ox campground at no charge along with enjoying a factory tour.

Again thank you for being our customer and for the confidence you have shown in the performance of our products. It is because of customers like you we enjoy the success we have today.



© 2008, 10 Blue Ox
One Mill Road, Industrial Park
Pender, Nebraska 68047
Phone: (402) 385-3051
Toll Free: (888) 425-5382
Fax: (402) 385-3360
www.blueox.com

General Information

1. Ensure that your product(s) are registered online at www.blueox.com. It is crucial to register your product(s) so that you may be alerted of product offerings, updates, upgrades, maintenance and safety bulletins, and/or recalls.
2. **It is the owner's responsibility to inspect all towing equipment for cracked welds, missing or worn parts and loose bolts before each towing trip.** Be sure to use Loctite® Red on all bolts and tighten to the recommended specifications.
3. **It is the owner's responsibility to hook up all towing equipment per manufacturer's instructions/recommendations.**
4. Remove the attachment tabs when not in use (if applicable).

Notice To Baseplate Installer

1. It is YOUR responsibility to watch for:

- Oil cooler and air conditioner lines
- Electrical wires and hoses
- Missing parts or attaching points on the frame

** If the baseplate is improperly installed and is against a wire or hose, it could cause fluid leaks or electrical shorts some time after the actual baseplate installation.

Permanent Baseplate Safety Cable Installation

Permanent baseplate safety cables are strongly recommended when towing a vehicle with a tow bar. The principle function of the permanent baseplate safety cables is to prevent the towed vehicle from breaking loose in the event the connection between the frame of the towed vehicle and the baseplate fails or becomes disconnected. The cables must be connected from the baseplate to the frame rail or cross member of the vehicle's frame. The illustrations below show the possible arrangements recommended by Blue Ox®. Each permanent baseplate safety cable must have an adequate weight rating for the towing system. The weight rating of the two (2) cables together will not qualify.

Do not mount the permanent baseplate safety cables against wires, hoses or brake lines.

These permanent baseplate safety cables should remain installed as long as the baseplate is installed on the vehicle. Permanent baseplate safety cables are to be used in conjunction with, and NOT a replacement for legally required safety cables attaching the towed vehicle to the towing vehicle.

OPTION #1

Permanent Baseplate Safety Cables to Cross Member or Frame of Towed Vehicle.

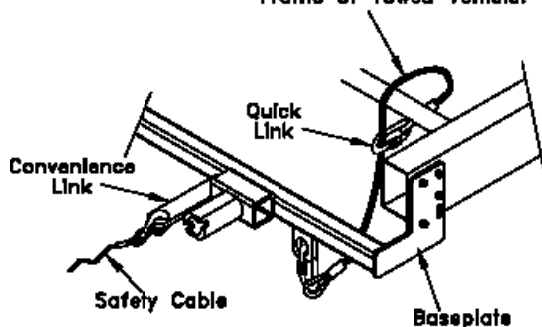

OPTION #2

Permanent Baseplate Safety Cables to Cross Member or Frame of Towed Vehicle.

