



**BX3784**

# 2008-15 Scion xB (with fog lights) Installation Instructions

**Serial Number**

**Please read BOTH these Installation Instructions and the General Towing Instructions before attempting to install or operate this equipment.**

1. Blue Ox® towing products and accessories are intended to be installed by Blue Ox® Dealers who are familiar with our products and have the equipment and knowledge to do “fit work.” When necessary, Blue Ox® Dealers can be found at [www.blueox.com](http://www.blueox.com) or by contacting our Customer Care Department at (402) 385-3051.

Attachment Tab Height: 12 1/2”  
Attachment Tab Width: 18”

2. Many Blue Ox® Baseplates are designed to use existing holes and hardware to mount the baseplate to the towed vehicle. Even though bolts are there, do not assume they are adequate for baseplate mounting. Always use hardware supplied in the hardware kit or existing hardware specified in the Baseplate Towing Installation Instructions.

**Bolt Torque Specifications**  
Torque in Foot-Pounds for Metric Bolts

Bolt Size	Grade 8.8	Grade 10.9
6MM	6	8
8MM	16	22
10MM	31	40
12MM	54	70
14MM	89	117

Confirm the towability and pre-towing procedures for your vehicle with the owner’s manual or contact the vehicle’s manufacturer for specific towing procedures.

**Bolt Torque Specifications**  
Torque in Foot-Pounds for Inch Bolts

Bolt Size	Grade 5	Grade 8
1/4”	10	14
5/16”	19	29
3/8”	33	47
7/16”	54	78
1/2”	78	119
5/8”	154	230



**If the front of your vehicle looks different than this, call us at (402) 385-3051.**

**! WARNING**

Failure to read and follow these instructions could result in separation of the towed vehicle from the tow bar, causing property damage, loss of towed vehicle, personal injury or death.



# BX3784

## 2008-15 Scion xB (with fog lights) Installation Instructions

### Parts List

Ref. No.	Qty.	Part #	Description
1	1	61-6622	WLDM'T, BASEPLATE, BX3784
2	9	61-5208	WLDT, NUT PLT, 1/4X1X1, 3/8" BLT WIR
3	8	201-0443	3/8-16 X 1" HEX BOLT GRD.5, ZP
4	5	201-0440	3/8-16 X 1 1/2" HEX BOLT, GRD.5, ZP
5	13	203-0010	3/8" LOCK WASHER, ZP
6	4	202-0003	3/8-16 HEX NUT, ZP
7	3	201-0655	6MM-1.0 X 30MM HEX BOLT, GRD8.8,ZP
8	5	203-0001	1/4" FLAT WASHER, ZP
9	1	107-2982	TUBE,5/8 OD(.120W) X 5/8 INCH
10	2	201-0979	#12-14 X 1" SELF DRILLING SCREW, ZP
11	2	201-0192	#10-32 X 1/2" SLOT, RD. HD. SCREW
12	2	203-0054	#10 LOCK WASHER
13	2	202-0047	#10-32 HEX NUT
14	2	101-5822	ADAPTER, 4 WAY CONNECTOR
15	2	62-3468	ATT TAB ASSY, SF/SB
	3	201-0654	#10-16 X 1" SELF DRILLING SCREW (not shown)
	2	229-0359	QUICKLINK, 3/8", ZP (not shown)
	2	226-0046	BASEPLATE SAFETY CABLE, 36" CL III (not shown)
	2	290-0437	RECEIVER, CAP PLUG (BLK) (not shown)

### Tools Required

10MM Socket	10MM Wrench	Drill
9/16" Socket	9/16" Wrench	Flat Screwdriver
3/8" Nut Driver	Utility Knife	Large Vise Grips
1" Hole Saw	Reciprocating Saw	13/32" Drill Bit
Loctite® RED		

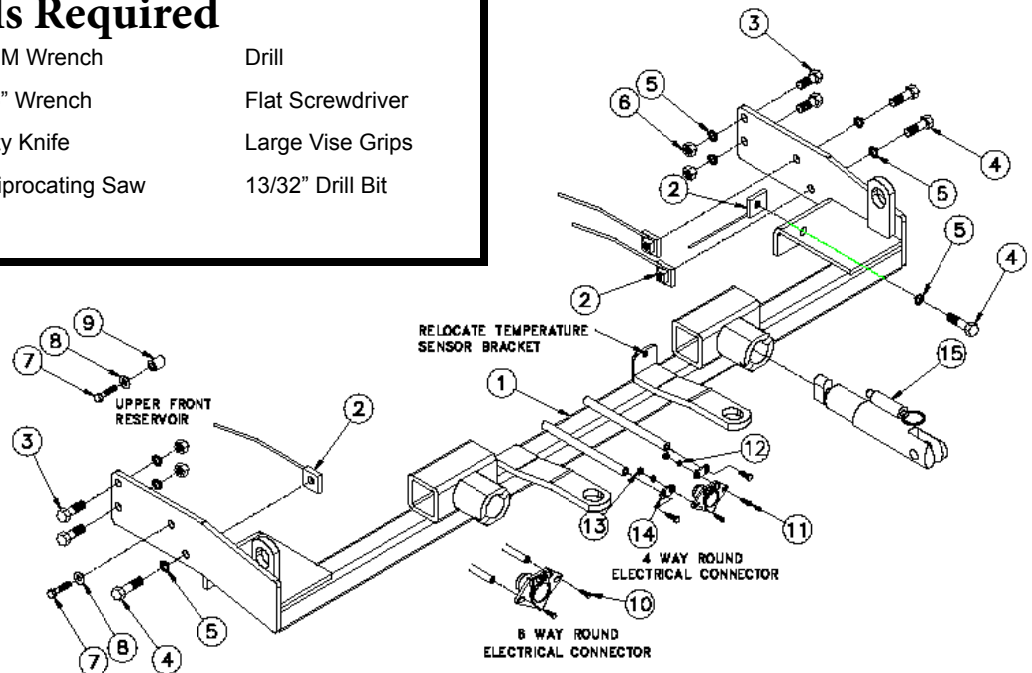

### Important:

Use only genuine factory replacement parts on your baseplate. Do **NOT** substitute homemade or non-typical parts. If a bolt is lost or in need of replacement, for your safety and the preservation of your baseplate, be sure to use a replacement bolt of the same grade (In most cases it will be Grade 5, please reference the parts list above). Replacement parts may be ordered through your nearest Blue Ox® Dealer or Distributor. Failing to follow and/or altering these installation instructions in either installation or required equipment will void the manufacturer's warranty. Towing behind a non-motorized vehicle will void the warranty.



# BX3784

## 2008-15 Scion xB (with fog lights)

### Installation Instructions

#### Vehicle Weight:

Motorhome mount tow bars are recommended for use with this baseplate. Due to the design of the removable tabs, the RangeFinderII, Adventurer, and Ambassador tow bars can not be used. The Acclaim tow bar may be used, but will not fold and store on the front of the vehicle. Adapters, except the BX8833 and BX88151, can not be used with this baseplate.

**Installation Notes:** The radiator cover, fascia, washer reservoir and vent tube are removed and reinstalled during installation of the baseplate. Drilling is required. Trimming of the lower frame support webbing is required.

The dimensional variations between otherwise identical vehicles can be considerable. While the baseplate was designed for easy installation, it may be necessary to tailor the baseplate slightly to compensate for auto manufacturer's tolerances. These minor adjustments may include filing a hole slightly, bending electrical rods or bending end plates.

The BX8869 Bulb and Socket Wiring Kit is recommended for this vehicle.



Possible location of the BX8869 Bulb & Socket Wiring Kit

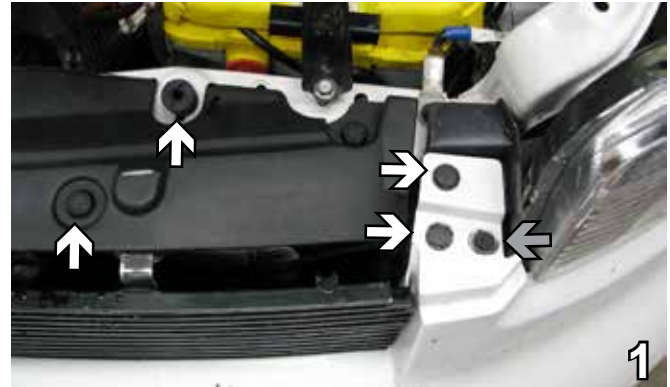

1. Using a flat screwdriver, remove four plastic push pins from the radiator cover driver's side and with a 10MM socket, remove one bolt from the outside edge (grey arrow). Set push pins and bolt aside to be reinstalled later.

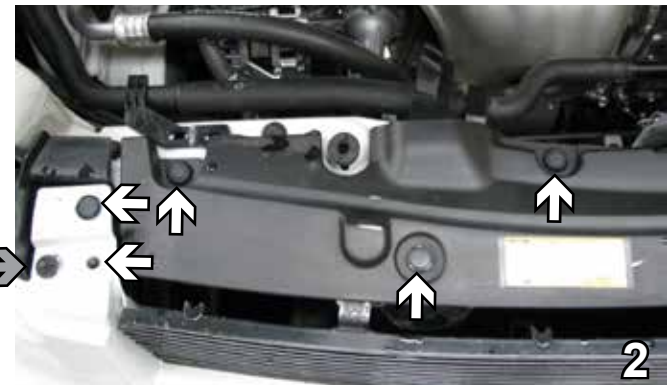

2. On the passenger side, using a flat screwdriver, remove five plastic push pins and with a 10MM socket, remove one metric bolt on the outside edge (grey arrow). Set push pins and bolt aside to be reinstalled later.

Handling of some cosmetic parts when installing this product may require the use of protective covers, rags, specialty tools, etc. to prevent damage.



**BX3784**

# 2008-15 Scion xB (with fog lights) Installation Instructions



3. Above the grill, remove the cover. Using a 10MM socket, remove two metric bolts. Using a flat screwdriver, remove push pin from the center (grey arrow). Set cover, bolts and pin aside to be reinstalled later.



4. Using 10MM socket, remove one metric bolt just forward of the front tire on bottom side of fascia. Using a flat screwdriver, turn the screw pin (grey arrow) 90° and the screw will pop out. Do this to both sides of vehicle. Set bolts and pins aside to be reinstalled later.



5. Remove eight metric bolts from lower edge of fascia all the way around using a 10MM socket. Pull fascia corners out to the side of the vehicle on both sides, then forward. Set aside fascia and bolts aside carefully for later reinstallation.

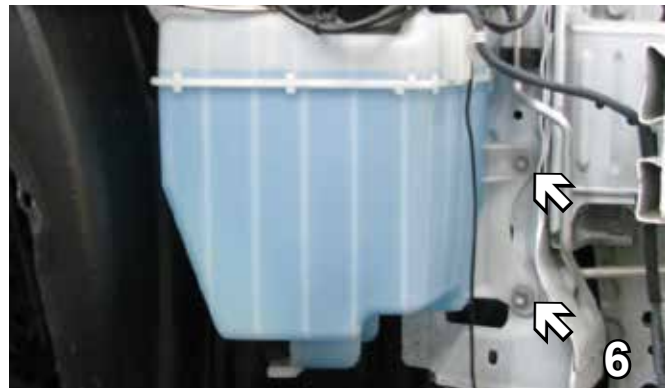

6. Using a 10MM socket, remove two bolts from the right side of the washer reservoir on the passenger side only. Set bolts aside for later reinstallation.

7. Using a 10MM socket, remove metric bolt from the top of the washer reservoir on the passenger side only. Disconnect wires and hoses. Set aside bolt for later reinstallation.



**BX3784**  
**2008-15 Scion xB**  
**(with fog lights)**  
**Installation Instructions**



8. Using a 10MM socket, remove the bolt from between wheel well cover and left side of washer reservoir on the passenger side only. Disconnect all electrical and fluid lines, then remove reservoir and bolt. Set aside for later reinstallation.



9. On the driver's side, using a flat screwdriver remove the push pin holding the vent tube. Also pull out the clip (grey arrow) from wire loom. Move the vent tube out of the way. Save the pin to reinstall later.

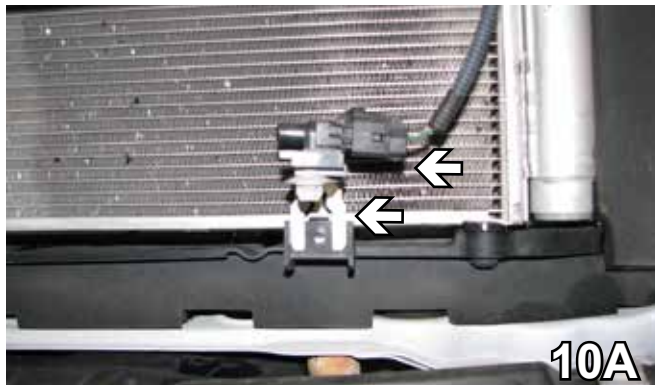

10. On the driver's side, remove the sensor and clip. Using a reciprocating saw, cut off the bracket flush with lower radiator support. Be sure not to damage radiator.



**BX3784**

## 2008-15 Scion xB (with fog lights) Installation Instructions

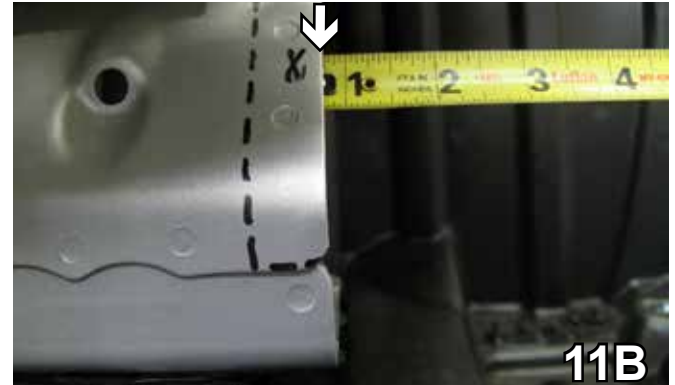
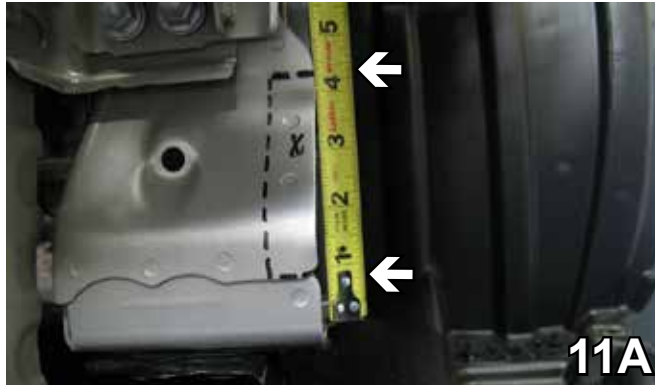

11. Using a reciprocating saw, cut a notch 3 1/2" long by 3/4" in lower frame support webbing. Do this on both sides. (Vertical cut should be flush with the side of support.)

**Using a good quality paint, spray cut edges of frame to prevent rusting.**

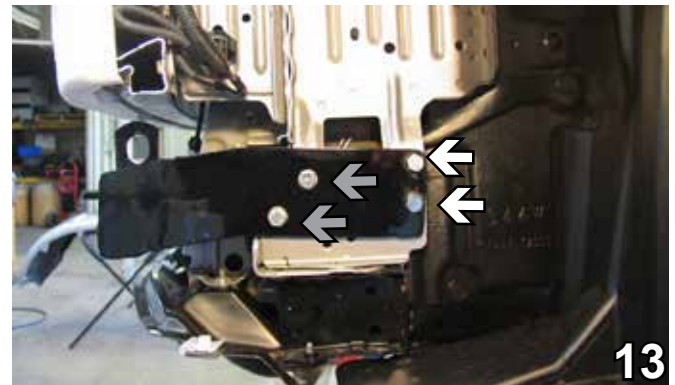

12. On the driver's side, slide the baseplate into the notch we cut out and as far back as possible, it should be flush with back webbing. Adjust to a level position with the vehicle and clamp with large vise grips. Do this on both sides. Using the baseplate as a template with a 13/32" drill bit, drill all four holes.

13. On the driver's side, the back two bolts (white arrows) are 3/8-16 x 1" hex bolts and 3/8" lock washers with 3/8-16 hex nuts. The front two (grey arrows) are 3/8-16 x 1 1/2" hex bolts with 3/8" lock washers and 1/4" x 1" x 1" nut plates inserted through the opening above the baseplate. Tighten all bolts with Loctite Red.

**When using power drills be aware of the dangers of torque and drill bit length.**

14. On the passenger side, start a 6MM-1.0 x 30MM hex bolt in existing hole, the lower front bolt location for the reservoir. Using the baseplate as a template, drill three holes into the frame and webbing with the 13/32" drill bit.

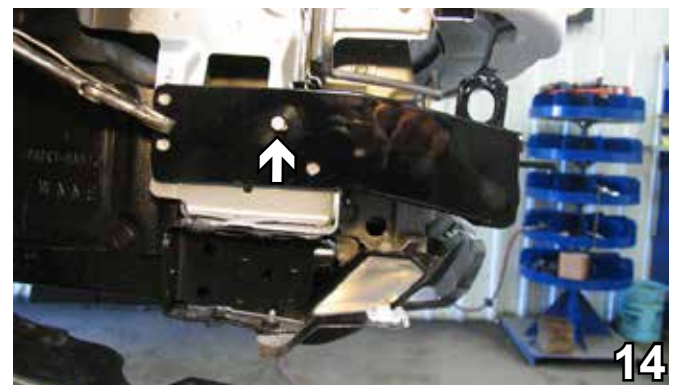



**BX3784**

# 2008-15 Scion xB (with fog lights) Installation Instructions

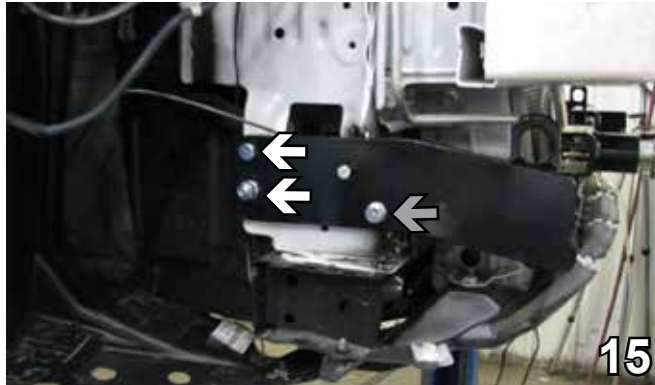

15. On the passenger side, the back two bolts (white arrows) are 3/8-16 x 1" hex bolts and 3/8" lock washers with 3/8-16 hex nuts. The front (grey arrow) is a 3/8-16 x 1 1/2" hex bolt with a 3/8" lock washer and 1/4" x 1" x 1" nut plate inserted through the opening above the baseplate. Tighten all bolts with Loctite Red.



16. Using the 13/32" drill bit, drill at an angle one hole using the baseplate as a template into the front of lower frame support. Do this on both sides.

**BE SURE TO USE LOCTITE® RED ON ALL BOLTS BEFORE TIGHTENING. TIGHTEN ALL BOLTS ACCORDING TO THE TORQUE CHART ON THE FRONT PAGE OF THESE INSTRUCTIONS OR ON PAGE 3 OF THE BASEPLATE TOWING GENERAL INSTRUCTIONS.**



17. Insert a 3/8-16 x 1 1/2" hex bolt with 3/8" lock washer and 1/4" x 1" x 1" nut plate into the opening on the side of frame support. Tighten with Loctite Red. Do the same on the other side.



18. To give reinforcement to frame webbing, using the 13/32" drill bit, drill two holes, insert 3/8-16 x 1" hex bolts. In the front (white arrow) use 1/4" x 1" x 1" nut plates and in the back (grey arrow) use 3/8" lock washers with 3/8-16 hex nuts. Tighten with Loctite Red. Do this on both sides.



19. Reattach washer reservoir, use 6MM-1.0 x 30MM hex bolts and a 1/4" flat washer. In the top, use a 5/8" tube spacer and a 1/4" flat washer.



**BX3784**

# 2008-15 Scion xB (with fog lights) Installation Instructions



20. Attach top and left washer reservoir with #10-16 x 1" self drilling screws with 1/4" flat washers into frame. Reattach all wires and hoses.



21. Reattach the vent tube using a #10-16 x 1" self drilling screw with a 1/4" flat washer.

22. Attach the permanent baseplate safety cables to the provided convenience link on the baseplate (see grey arrow). The photo above shows the recommended installation of the cables to frame of vehicle (see white arrow). Additional options may interfere with suggested mounting; in this case secure the cables to a solid piece of the frame as described in the instructions included with the permanent baseplate safety cables. Be sure the safety cables do not rub against any hoses or moving parts. Do this to both sides of the vehicle.



23. Put the temperature sensor back on the little plate in front of the radiator.

Be sure that **ALL** electrical connections are plugged in properly and functioning **BEFORE** installing the fascia.

24. Reinstall fascia, radiator cover, bolts and push pins.





**BX3784**

# 2008-15 Scion xB (with fog lights) Installation Instructions

Install the tow bar and safety cables according to the instructions provided in their packages. When demonstrating to customer, be sure to include all original content and packages. Do **NOT** substitute other devices if the tow bar pins and clips are misplaced.

**DEALER or INSTALLER:**  
**Be certain the user receives the instruction sheets for their products.**

## CUSTOMER SERVICE COMMITMENT



**Shown without removable tabs installed.**

Blue Ox is committed to providing you with exceptional customer care throughout your lifetime with our products. Our team is here to assist you with any questions you may have regarding the performance of your product. Simply call (402) 385-3051 and you can speak with our customer care team.

Additionally, please visit our website to see which rallies our Destination America team will be attending. For a nominal fee, our service technician will service your towing system to ensure it's in proper working condition. Also as a commitment to our customers, should you visit our factory you can stay at our full service Blue Ox campground at no charge along with enjoying a factory tour.



**Shown with removable tabs installed.**

Again thank you for being our customer and for the confidence you have shown in the performance of our products. It is because of customers like you we enjoy the success we have today.

If the baseplate is in an accident, it must be replaced. **DO NOT** use it again! An accident can cause unseen damage and using it again could result in more damage or serious injury. **DO NOT** use the baseplate if it is damaged or missing parts.



© 2009, 10 Blue Ox  
One Mill Road, Industrial Park  
Pender, Nebraska 68047  
Phone: (402) 385-3051  
Fax: (402) 385-3360  
[www.blueox.com](http://www.blueox.com)

# General Information

1. Ensure that your product(s) are registered online at [www.blueox.com](http://www.blueox.com). It is crucial to register your product(s) so that you may be alerted of product offerings, updates, upgrades, maintenance and safety bulletins, and/or recalls.
2. **It is the owner's responsibility to inspect all towing equipment for cracked welds, missing or worn parts and loose bolts before each towing trip.** Be sure to use Loctite® Red on all bolts and tighten to the recommended specifications.
3. **It is the owner's responsibility to hook up all towing equipment per manufacturer's instructions/recommendations.**
4. Remove the attachment tabs when not in use (if applicable).

## Notice To Baseplate Installer

### 1. It is YOUR responsibility to watch for:

- Oil cooler and air conditioner lines
- Electrical wires and hoses
- Missing parts or attaching points on the frame

\*\* If the baseplate is improperly installed and is against a wire or hose, it could cause fluid leaks or electrical shorts some time after the actual baseplate installation.

## Permanent Baseplate Safety Cable Installation

Permanent baseplate safety cables are strongly recommended when towing a vehicle with a tow bar. The principle function of the permanent baseplate safety cables is to prevent the towed vehicle from breaking loose in the event the connection between the frame of the towed vehicle and the baseplate fails or becomes disconnected. The cables must be connected from the baseplate to the frame rail or cross member of the vehicle's frame. The illustrations below show the possible arrangements recommended by Blue Ox®. Each permanent baseplate safety cable must have an adequate weight rating for the towing system. The weight rating of the two (2) cables together will not qualify.

***Do not mount the permanent baseplate safety cables against wires, hoses or brake lines.***

These permanent baseplate safety cables should remain installed as long as the baseplate is installed on the vehicle. Permanent baseplate safety cables are to be used in conjunction with, and NOT a replacement for legally required safety cables attaching the towed vehicle to the towing vehicle.

### OPTION #1

Permanent Baseplate Safety Cables to Cross Member or Frame of Towed Vehicle.

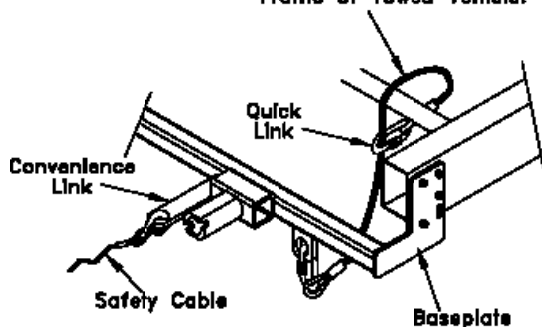

### OPTION #2

Permanent Baseplate Safety Cables to Cross Member or Frame of Towed Vehicle.

