



BX2638

2013-14 Ford Taurus (No Adaptive Cruise Control) Installation Instructions

Serial Number

Attachment Tab Height: 15"

Attachment Tab Width: 20"

Please read **BOTH** these Installation Instructions and the General Instructions prior to installing or operating this equipment.

- Blue Ox® towing products and accessories are intended to be installed by Blue Ox® Dealers who are familiar with our products and have the equipment and knowledge necessary to do "fit work". If needed, Blue Ox® Dealers can be found at www.blueox.com or by contacting our Technical Service Department at (402) 385-3051.
- Many Blue Ox® baseplates are designed to use existing holes and hardware to mount the baseplate to the towed vehicle. Even though bolts are there, do not assume they are adequate for baseplate mounting. Always use the hardware supplied in the hardware kit and existing hardware as specified in the installation instructions.

Bolt Torque Specifications
Torque in Foot-Pounds for Inch Bolts

Bolt Size	Grade 5	Grade 8
1/4"	10	14
5/16"	19	29
3/8"	33	47
7/16"	54	78
1/2"	78	119
5/8"	154	230
3/4"	257	380



Bolt Torque Specifications
Torque in Foot-Pounds for Metric Bolts

Bolt Size	Grade 8.8	Grade 10.9
6MM	6	8
8MM	16	22
10MM	31	40
12MM	54	70
14MM	89	117
16MM	161	230
18MM	222	318

If the front of your vehicle looks different than this, please contact us at (402)385-3051.

Reference your vehicle owner's manual for manufacturer's towing specifications.

! WARNING

Failure to read and follow these instructions could result in separation of the towed vehicle from the tow bar, causing property damage, loss of towed vehicle, personal injury or death.

BX2638
2013-14 Ford Taurus (No Adaptive Cruise Control)
Installation Instructions

Instruction Notes: The fascia, windshield washer fluid reservoir, air horn and air shutters are removed and reinstalled for the baseplate installation. Some drilling and trimming is required.

Place all components that are removed on a flat, sturdy surface. All items will be reinstalled unless otherwise noted after the baseplate is installed.

The dimensional variations between otherwise identical vehicles can be considerable. While the baseplate was designed for easy installation, it may be necessary to tailor the baseplate slightly to compensate for vehicle manufacturer's tolerances.

The BX8848 4 Diode Wiring Kit is recommended for this vehicle.

NOTICE

- Handling of some cosmetic parts when installing this product may require the use of protective covers, rags, specialty tools, etc. to prevent damage.
- When using power drills be aware of the dangers of torque and drill bit length.
- When using a reciprocating saw be aware of objects behind the cutting surface.
- Use a good quality paint to spray cut edges of frame to prevent rusting.
- Be sure that **ALL** electrical connections are plugged in and accessories are functioning properly before reinstalling the fascia.
- The baseplate is computer tested to your vehicle's GVWR, exceeding this weight will void the manufacturer's warranty.
- Be sure to use Loctite® Red on all bolts before tightening. Tighten all bolts according to the torque chart provided.
- Dealer or installer be certain the user receives these instruction sheet.
- If the baseplate is in an accident, it must be replaced. **DO NOT** use it again! An accident can cause unseen damage and using it again could result in more damage or serious injury. **DO NOT** use the baseplate if it is damaged or missing parts.

BX2638

2013-14 Ford Taurus (No Adaptive Cruise Control)

Installation Instructions

Tools Required

Large Vise Grip
 Flat Screwdriver
 Utility Knife
 Phillips Screwdriver
 Torque Wrench
 Drill
 Tape Measure
 Loctite® RED
 13/32" Drill Bit
 5.5MM Socket
 8MM Socket
 11MM Socket
 9/16" Socket

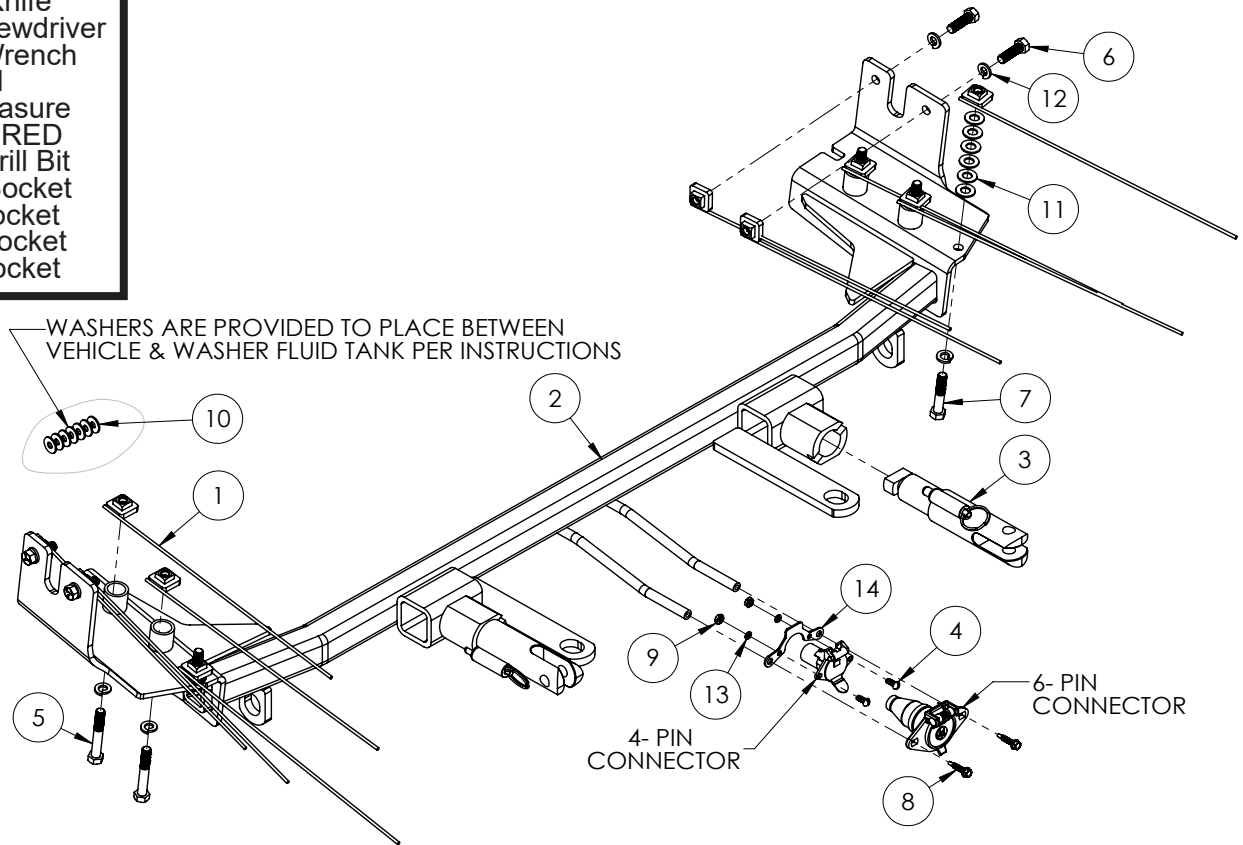

Item No.	Part No.	Description	Qty.
1.....	61-5208.....	3/8"-16 Nut Plate with 14" Wire.....	10
2.....	61-7078.....	BX2638 Baseplate.....	1
3.....	62-3468.....	Attachment Tab Assembly.....	2
4.....	201-0192.....	#10-32 x 1/2" Slot Head Screw.....	2
5.....	201-0336.....	3/8"-16 x 2-1/2" Hex Head Bolt, Grade 5, ZP.....	4
6.....	201-0368.....	3/8"-16 x 1-1/4" Hex Head Bolt, Grade 5, ZP.....	4
7.....	201-0444.....	3/8"-16 x 2" Hex Head Bolt, Grade 5, ZP.....	2
8.....	201-0979.....	#12-14 x 1" Self Drilling Screw, ZP.....	2
9.....	202-0047.....	#10-32 Hex Nut.....	2
10.....	203-0001.....	1/4" Flat Washer, ZP.....	7
11.....	203-0003.....	3/8" Flat Washer, ZP.....	12
12.....	203-0010.....	3/8" Lock Washer, ZP.....	10
13.....	203-0054.....	#10 Lock Washer.....	2
14.....	299-0685.....	Electrical Bracket.....	1
15.....	226-0049(not shown).....	Class IV Safety Cables.....	2
16.....	229-0512(not shown).....	1/2" Quicklink, ZP.....	2
17.....	290-0437(not shown).....	Black Cap Plug Receiver.....	2

Important:

Use only genuine factory replacement parts on your baseplate. Do **NOT** substitute homemade or non-typical parts. If a bolt is lost or in need of replacement, for your safety and the preservation of your baseplate, be sure to use a replacement bolt of the same grade (In most cases it will be Grade 5, please reference the parts list above). Replacement parts may be ordered through your nearest Blue Ox® Dealer or Distributor. Failing to follow and/or altering these installation instructions in either installation or required equipment will void the manufacturer's warranty. Towing behind a non-motorized vehicle will void the warranty.

BX2638
2013-14 Ford Taurus (No Adaptive Cruise Control)
Installation Instructions

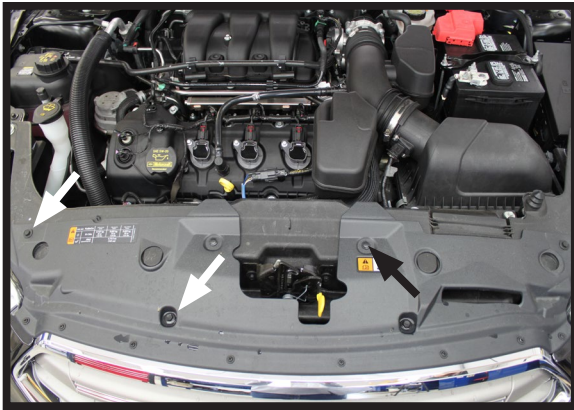

1. Using a 10MM socket, remove the four (4) bolts, two (2) per side. Use a flat screwdriver to pry the push pin out. There are two (2) located toward the center of the vehicle.



2. Remove the three (3) bolts located on the outer edge of the wheel well area with a 5.5MM socket. Do this on both sides of the vehicle.



3. At the top of the wheel well area is a push pin. It requires the use of a Phillips screwdriver to remove. Do this on both sides of the vehicle.



4. Using an 8MM socket, remove the one (1) bolt that is towards the bottom, directly behind the tire. Do this on both sides of the vehicle.



5. On the underside of the vehicle there are five (5) push pins. There is one (1) in the center and two (2) per side. Use a Phillips screwdriver to remove them.

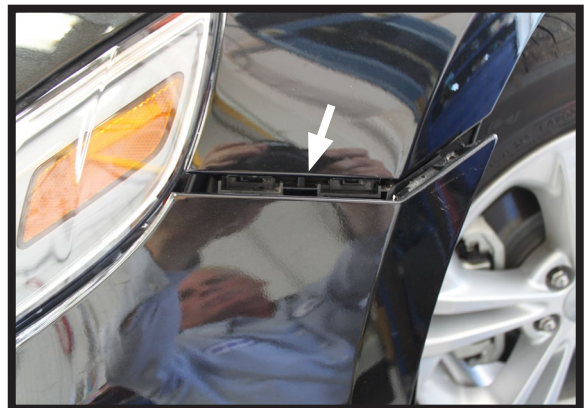

6. Gently, yet firmly, lift the sides of the fascia and pull outward.

BX2638
2013-14 Ford Taurus (No Adaptive Cruise Control)
Installation Instructions

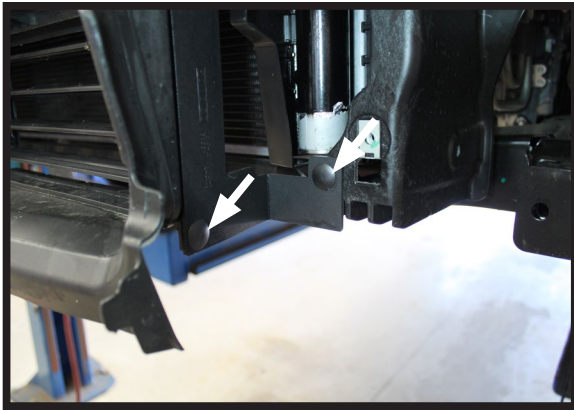

7. Use a flat screwdriver to remove the two (2) push pins on the air dam support brackets. These brackets are located on the side of the air dam.

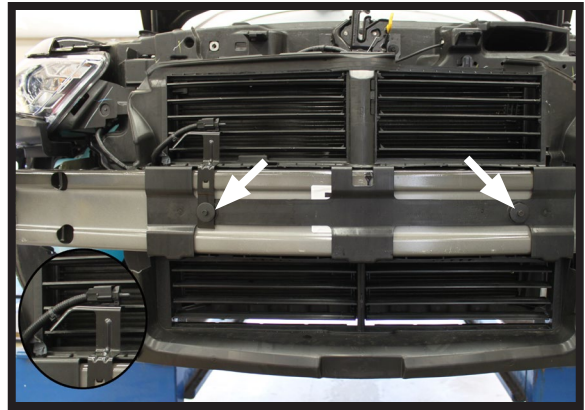

8. Using an 8MM socket, remove the two (2) bolts. Unclip the air temperature sensor and place to the side.

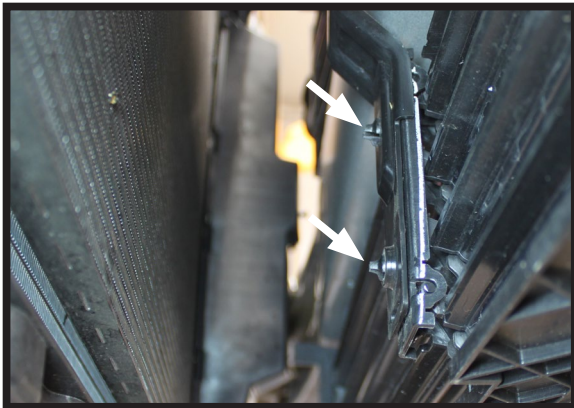

9. On the backside of the air shutter there are three (3) clamps. Tightly squeeze the clamp button to release. There are three (3) buttons on each clamp, two (2) towards the bottom and one (1) towards the top.

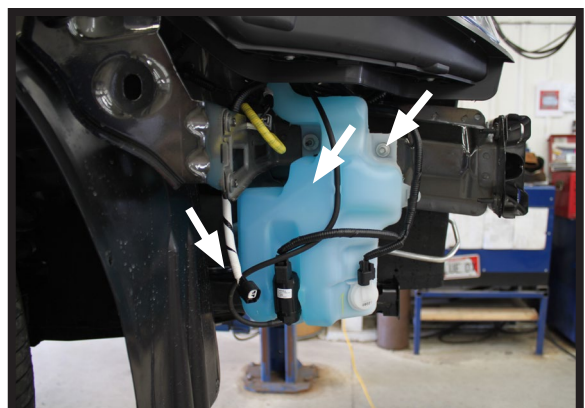

10. The windshield wiper fluid reservoir needs to be removed on the passenger side. Unplug all electrical components and remove the bolts. On the top, right side, remove the bolt using an 8MM socket. The other two (2) bolts require a 11MM socket for removal.



11. On the driver's side, remove the air horn using an 8MM socket.



12. Clamp the baseplate securely into place and verify it is properly aligned.

BX2638
2013-14 Ford Taurus (No Adaptive Cruise Control)
Installation Instructions

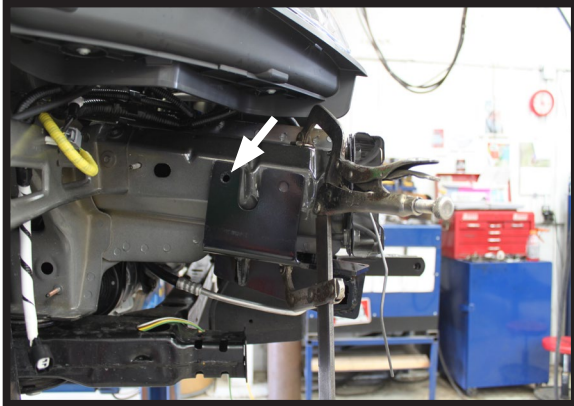

13. Drill one (1) hole using a 13/32" drill bit. Do this on both sides of the vehicle. Recheck the baseplate for proper alignment. After making any adjustments necessary, drill the second hole on each side.

Insert the 3/8"-16 x 1-1/4" hex head bolts and 3/8" lock washers.



14. Drill the three (3) bottom holes using a 13/32" drill bit.

On the front hole only: Insert six (6) 3/8" flat washers on the top as shown. Next insert one (1) 3/8"-16 x 2" hex head bolt and 3/8" lock washer into the front hole.

The back holes require a 3/8"-16 x 2-1/2" hex head bolt and 3/8" lock washer.

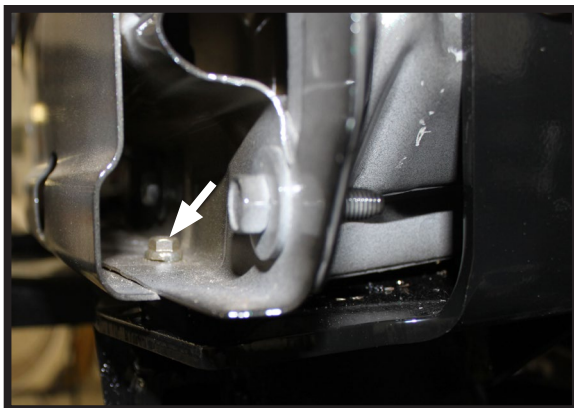

15. On the driver's side only: Use a flat chisel and hammer to remove the nut that is located on the outer edge inside the vehicle frame rail.

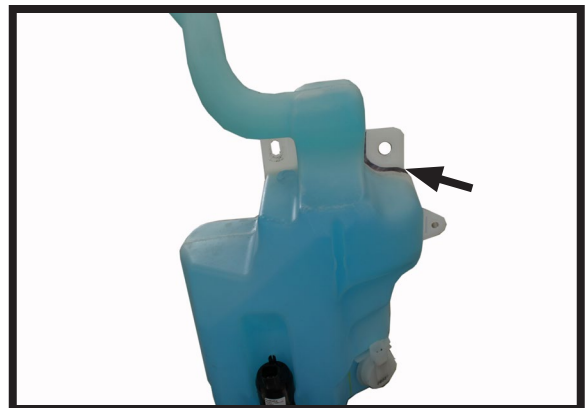

16. Prior to reinstalling the windshield wiper fluid reservoir, notch as shown above.

BX2638
2013-14 Ford Taurus (No Adaptive Cruise Control)
Installation Instructions

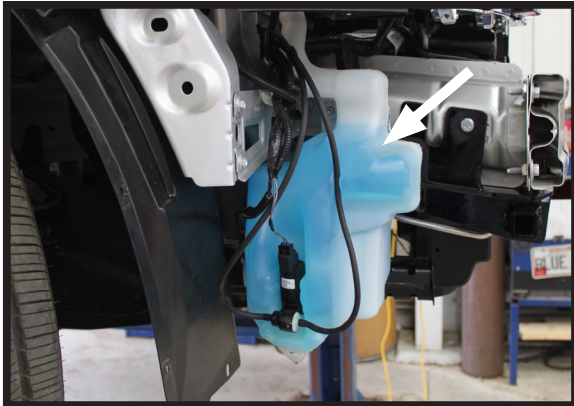

17. Reattach all electrical wiring and fluid lines.

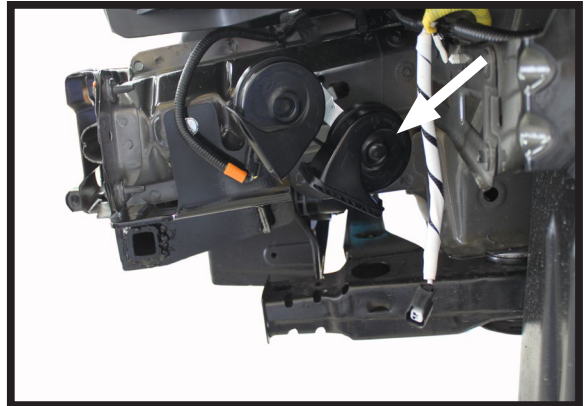

18. Reinstall the air horn to the original location. It may require bending slightly to allow for ample clearance.

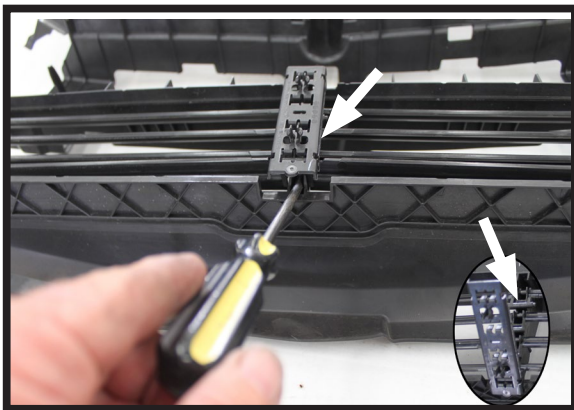

19. Lay the air shutter on a flat, sturdy surface. Insert a flat screwdriver into the top portion of the air shutter bracket and pop up. Do the same on the bottom portion.

Lift up on the air shutter bracket and using the flat screwdriver pry the bottom three (3) shutters out.

NOTE: Be sure to save the shutters so they can be replaced in the event the baseplate would be removed.

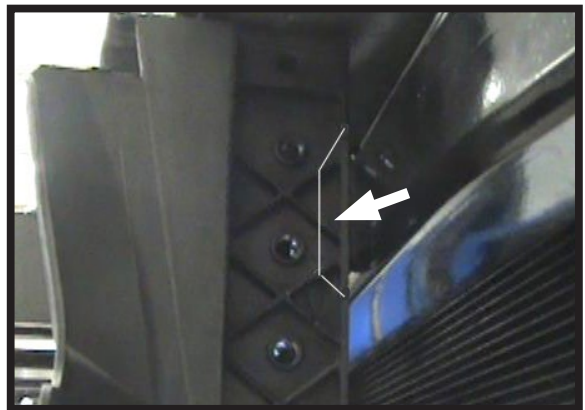

20. Prior to reinstalling the air shutter side brackets, set upright and notch as shown above.



21. Measure down 1-1/4" and all the way over to the outer edge on the backside of the front fascia. Notch this as shown to allow for proper clearance.

BX2638
2013-14 Ford Taurus (No Adaptive Cruise Control)
Installation Instructions

22. Attach the permanent baseplate safety cables to the provided convenience link on the baseplate. Additional options may interfere with suggested mounting; in this case, secure the cables to a solid piece of the frame as described in the instructions included with the permanent baseplate safety cables. Be sure the safety cables do not rub against any hoses or moving parts. Do this on both sides of the vehicle.

23. Reinstall the air shutter bracket. Hold the fascia as close to it's original position, mark then trim for clearance of the attachment tabs and convenience links. Reinstall the fascia.



CUSTOMER SERVICE COMMITMENT

Blue Ox® is committed to providing you with exceptional customer care throughout your lifetime with our products. Our team is here to assist you with any questions you may have regarding the performance of your product. Simply call (402) 385-3051 and you can speak with our customer care team.

Additionally, please visit our website to see which rallies our Destination America team will be attending. For a nominal fee, our service technician will service your towing system to ensure it's in proper working condition. Also, as a commitment to our customers, should you visit our factory, you can stay at our full service Blue Ox® campground at no charge along with enjoying a factory tour.

Again, thank you for being our customer and for the confidence you have shown in the performance of our products. It is because of customers like you we enjoy the success we have today.

© 2013 Blue Ox
One Mill Road, Industrial Park
Pender, Nebraska 68047
Phone: (402) 385-3051
Fax: (402) 385-3360
www.blueox.com