



BX2630

2011-14 Lincoln Navigator 2011-14 Ford F-150 King Ranch/SVT Raptor Installation Instructions

Serial Number

Please read **BOTH** these Installation Instructions and the General Towing Instructions before attempting to install or operate this equipment.

- Blue Ox® towing products and accessories are intended to be installed by Blue Ox® Dealers who are familiar with our products and have the equipment and knowledge to do “fit work.” When necessary, Blue Ox® Dealers can be found at www.blueox.com or by contacting our Customer Care Department at (402) 385-3051.
- Many Blue Ox® baseplates are designed to use existing holes and hardware to mount the baseplate to the towed vehicle. Even though bolts are there, do not assume they are adequate for baseplate mounting. Always use hardware supplied in the hardware kit or existing hardware specified in the Baseplate Towing Installation Instructions.

Attachment Tab Height: 19”

Attachment Tab Width: 34-1/2”

Bolt Torque Specifications		
Torque in Foot-Pounds for Metric Bolts		
Bolt Size	Grade 8.8	Grade 10.9
6MM	6	8
8MM	16	22
10MM	31	40
12MM	54	70
14MM	89	117

Confirm the towability and pre-towing procedures for your vehicle with the owner’s manual or contact the vehicle’s manufacturer for specific towing procedures.

Bolt Torque Specifications		
Torque in Foot-Pounds for Inch Bolts		
Bolt Size	Grade 5	Grade 8
1/4”	10	14
5/16”	19	29
3/8”	33	47
7/16”	54	78
1/2”	78	119
5/8”	154	230



If the front of your vehicle looks different than this or those shown on page 13, call us at (402) 385-3051.

WARNING

Failure to read and follow these instructions could result in separation of the towed vehicle from the tow bar, causing property damage, loss of towed vehicle, personal injury or death.

BX2630
2011-14 Lincoln Navigator
2011-14 Ford F-150 King Ranch/SVT Raptor
Installation Instructions

Tools Required

Large Vise Grip
 Utility Knife
 Torque Wrench
 Drill
 Tape Measure
 Loctite® RED
 5/16" Drill Bit
 17/32" Drill Bit
 5.5MM Socket
 7MM Socket
 10MM Socket
 13MM Socket
 15MM Socket
 17MM Wrench
 21MM Socket
 3/4" Socket
 3/4" Wrench
 T40 Torx

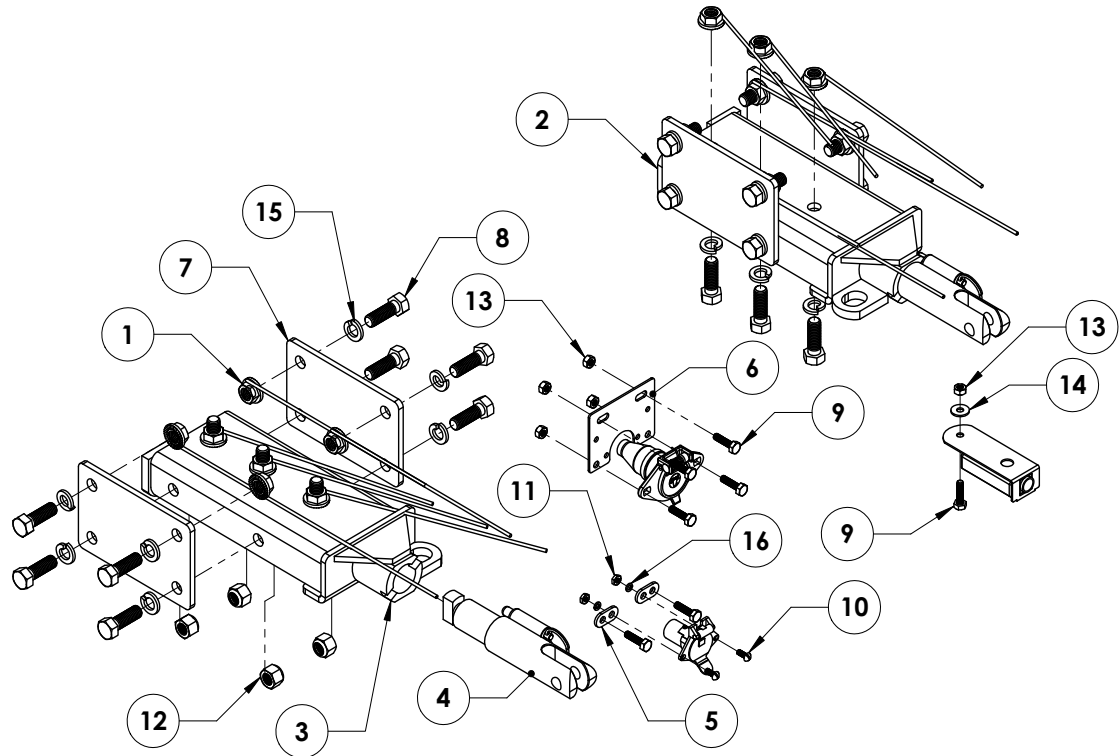

Item No.	Part No.	Description	Qty.
1.....	61-4029.....	1/2"-13 Nut w/10" Wire	14
2.....	61-6876.....	BX2630 Baseplate, DS.....	1
3.....	61-6877.....	BX2630 Baseplate, PS.....	1
4.....	62-3468.....	Attachment Tab.....	2
5.....	101-5822.....	4-Way Adapter Conector	2
6.....	101-6845.....	Electrical Bracket.....	1
7.....	101-7714.....	BX2630 Side Support Plate.....	4
8.....	201-0051.....	1/2"-13 x 1-1/2" Hex Head Bolt, Grade 5, ZP	22
9.....	201-0071.....	1/4"-20 x 1" Hex Head Bolt, Grade 5, ZP	7
10.....	201-0192.....	#10-32 x 1/2" Slot Round Head Screw	2
11.....	202-0047`.....	#10-32 Hex Nut	2
12.....	202-0094.....	1/2"-13 Hex Lock Nut, ZP	8
13.....	202-0102.....	1/4"-20 Hex Nylon Nut, ZP	5
14.....	203-0001.....	1/4" Flat Washer, ZP.....	1
15.....	203-0012.....	1/2" Lock Washer, ZP	22
16.....	203-0054.....	#10 Lock Washer.....	2
17.....	226-0049(not shown).....	Class IV Safety Cables.....	2
18.....	229-0512(not shown).....	1/2" Quicklink, ZP	2
19.....	290-0437(not shown).....	Black Cap Plug Receiver.....	2

Important:

Use only genuine factory replacement parts on your baseplate. Do NOT substitute homemade or non-typical parts. If a bolt is lost or in need of replacement, for your safety and the preservation of your baseplate, be sure to use a replacement bolt of the same grade (In most cases it will be Grade 5, please reference the parts list above). Replacement parts may be ordered through your nearest Blue Ox® Dealer or Distributor. Failing to follow and/or altering these installation instructions in either installation or required equipment will void the manufacturer's warranty.

BX2630
2011-14 Lincoln Navigator
2011-14 Ford F-150 King Ranch/SVT Raptor
Installation Instructions

Vehicle Weight: The weight of this vehicle is near the Class III, 5,000 lbs rating limitations. Some models, depending on options, may well exceed this 5,000 lb rating. Be sure to confirm the weight of your individual vehicle before towing and insure your tow bar, hitch and all equipment has an appropriate rating. Tow Bar adapters are not to be used with vehicle's weighing over 5,000 lbs.

Installation Notes: The belly pan on the Raptor must be removed and replaced during installation. Some drilling is required. Tow hooks must be removed and remain off the vehicle after installation.

The dimensional variations between otherwise identical vehicles can be considerable. While the baseplate was designed for easy installation, it may be necessary to tailor the baseplate slightly to compensate for auto manufacturer's tolerances. These minor adjustments may include filing a hole slightly, bending electrical rods or bending end plates.

The BX8869 Bulb and Socket Wiring Kit is recommended for this vehicle.



Handling of some cosmetic parts when installing this product may require the use of protective covers, rags, specialty tools, etc. to prevent damage.

Installation Instructions: Ford F-150 Raptor SVT



1. Using a 15MM socket, remove the two metric bolts from the back side of the belly pan, located underneath the vehicle. Set bolts aside to be reinstalled later.

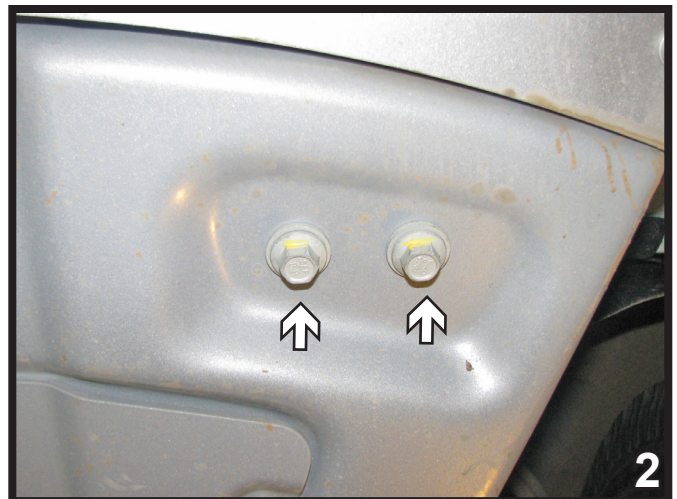

2. Using a 15MM socket, remove two bolts from the belly pan on each side under the tow hooks. Do this on both sides of the vehicle. Set the belly pan and bolts aside to be reinstalled later.

BX2630
2011-14 Lincoln Navigator
2011-14 Ford F-150 King Ranch/SVT Raptor
Installation Instructions

Ford F-150 Raptor SVT continued

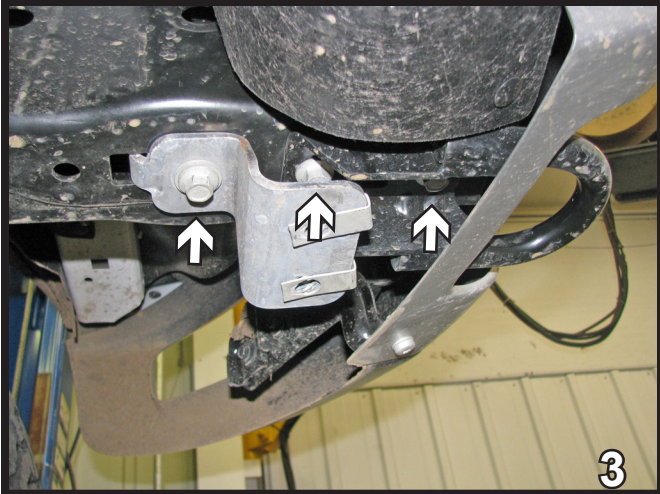

3. Remove the tow hook from both sides by removing three bolts on underside of tow hook using an 15MM socket. Do this on both sides of the vehicle. Set tow hooks, plate and bolts aside. Tow hooks will not be reinstalled.

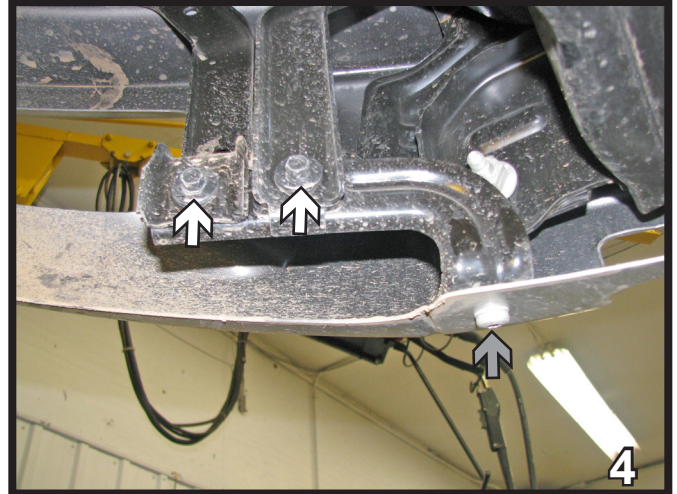

4. Using a T40 Torx, remove one bolt on the edge of the bumper bracket (grey arrow). Using a 10MM socket, remove two bolts from the bottom of the bracket (white arrows). Do this on both sides of the vehicle. Set the bolts aside to be reinstalled later.



5. Using a 10MM socket, remove one bolt from the top of the bracket. Do this to both sides of the vehicle. Set bolts and bracket aside to be reinstalled later.



6. Slide the baseplate in through the tow hook opening and hold in place with the large vise grip. Do this to both sides.

BX2630
2011-14 Lincoln Navigator
2011-14 Ford F-150 King Ranch/SVT Raptor
Installation Instructions

Ford F-150 Raptor SVT continued

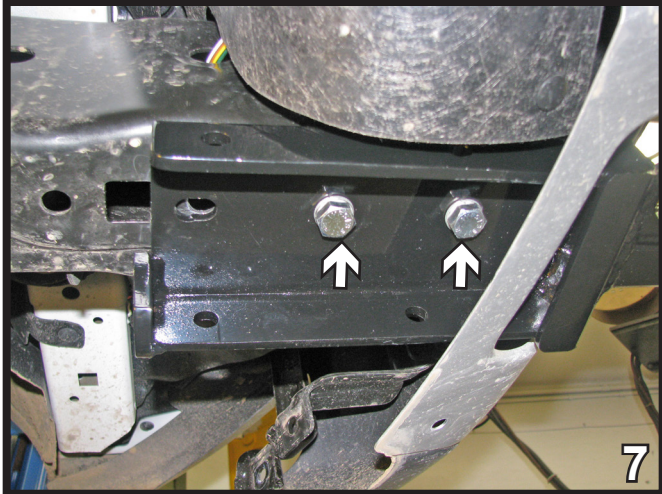

7. Align the baseplate with the existing holes in the tow hook bracket. Start the middle 1/2-13 x 1 1/2" bolt with 1/2" lock washer attach to 1/2-13 whiz nut with wire. Then install the same hardware in the front hole. Do this on both sides.

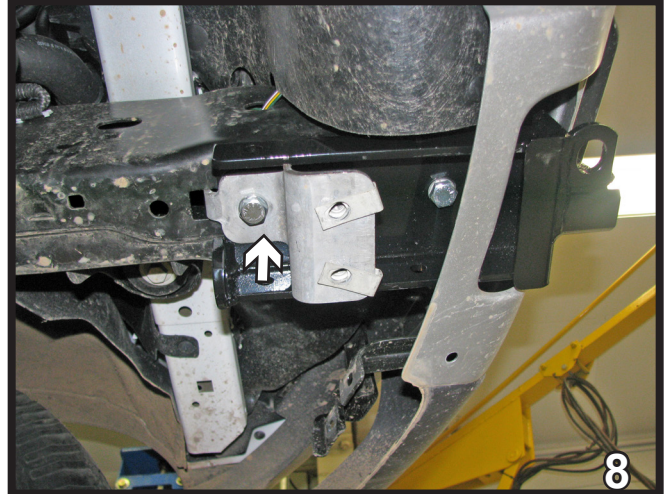

8. Drill out the existing hole in the belly pan bracket with a 17/32" drill bit. Position the bracket and hand tighten with 1/2-13 x 1 1/2" bolt, 1/2" lock washer and 1/2-13 whiz nut with wire. Do this on both sides. Belly pan bracket will need to be adjusted later to align with belly pan when reinstalling.

BE SURE TO USE LOCTITE® RED ON ALL BOLTS BEFORE TIGHTENING. TIGHTEN ALL BOLTS ACCORDING TO THE TORQUE CHART ON THE FRONT PAGE OF THESE INSTRUCTIONS OR ON PAGE 3 OF THE BASEPLATE TOWING GENERAL INSTRUCTIONS.

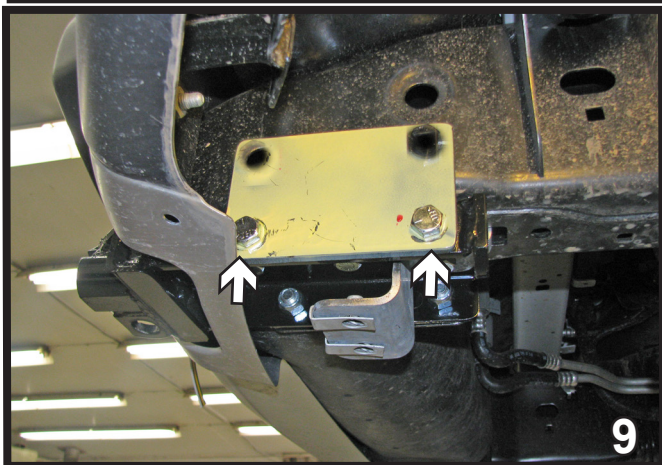

9. Position a side support plate to each side of the baseplate. Install 1/2-13 x 1 1/2" bolts with 1/2" lock washers and 1/2-13 hex nuts on the bottom. Using the plate as a template with a 17/32" drill bit, drill the top two holes into the frame. Do this on both sides of the baseplate and both sides of the vehicle (4 plates).

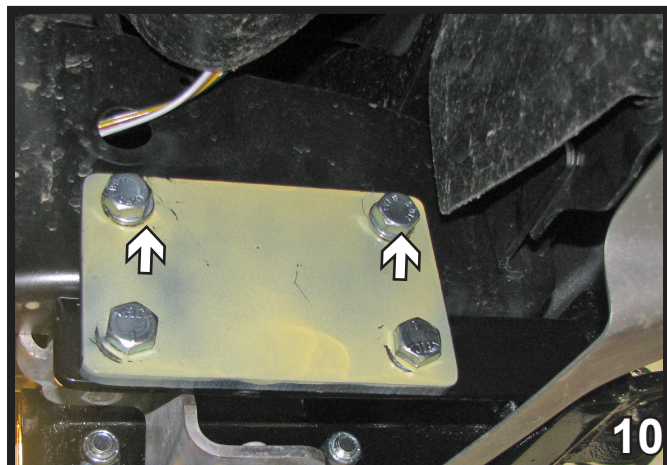

10. Attach the top holes with 1/2-13 x 1 1/2" bolts, 1/2" lock washers and 1/2-13 whiz nuts with wire. Do this on both sides of the baseplate and both sides of the vehicle.

When using power drills be aware of the dangers of torque and drill bit length.

BX2630
2011-14 Lincoln Navigator
2011-14 Ford F-150 King Ranch/SVT Raptor
Installation Instructions

Ford F-150 Raptor SVT continued



11. Attach the permanent baseplate safety cables to the provided convenience link on the baseplate (white arrow). The photo above shows the recommended installation of the cables to the frame of vehicle (gray arrow). Additional options may interfere with the suggested mounting. In this case, secure the cables to a solid piece of the frame as described in the instructions included with the permanent baseplate safety cables. Be sure the safety cables do not rub against any hoses or moving parts. Do this on both sides of the vehicle.



12. Install the electrical bracket to the front fascia. Reinstall the belly pan, bolts and bracket.



With removable attachment tabs.



13. **Optional:** Use a T40 Torx to remove a metric bolt underneath the fascia on the drivers side. Attach the breakaway in that location with the existing bolt.



Without removable attachment tabs.

BX2630
2011-14 Lincoln Navigator
2011-14 Ford F-150 King Ranch/SVT Raptor
Installation Instructions

Lincoln Navigator



1. Remove the tow hook from both sides by removing the two bolts on the underside of the tow hook using a 15MM socket. Set two hooks and bolts aside, they will not be reinstalled. Do this on both sides of the vehicle.



2. Forward of the front tire on the wheel well, using a 7MM socket, remove two bolts. Do this to both sides. Set bolts aside to be reinstalled later.



3. Using a 5.5MM socket, remove one bolt from the wheel well. Do this to both sides of the vehicle. Set bolts aside to be reinstalled later.



4. Slide the baseplate in through the tow hook opening and hold in place with the large vise grip. Do this to both sides.

BX2630
2011-14 Lincoln Navigator
2011-14 Ford F-150 King Ranch/SVT Raptor
Installation Instructions

Lincoln Navigator continued

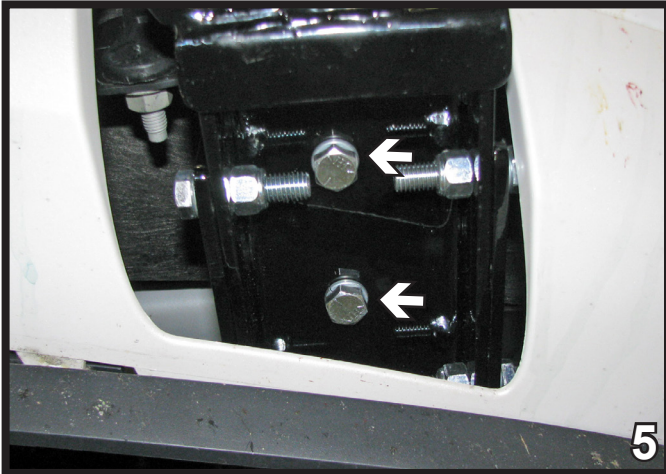

5. Start the 1/2-13 x 1 1/2" bolts with 1/2" lock washers attached to 1/2-13 whiz nuts with wire in the bottom front two holes. Do this on both sides.

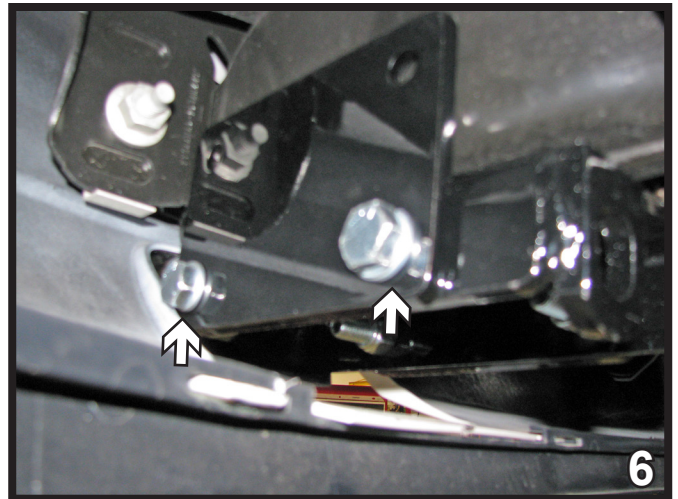

6. Position a side support plate to each side of the baseplate. Install 1/2-13 x 1 1/2" bolts with 1/2" lock washers and 1/2-13 hex nuts. Do this on both sides of the baseplate and both sides of the vehicle.

Be sure to use loctite® red on all bolts before tightening. Tighten all bolts according to the torque chart on the front page of these instructions or on page 3 of the baseplate towing general instructions.

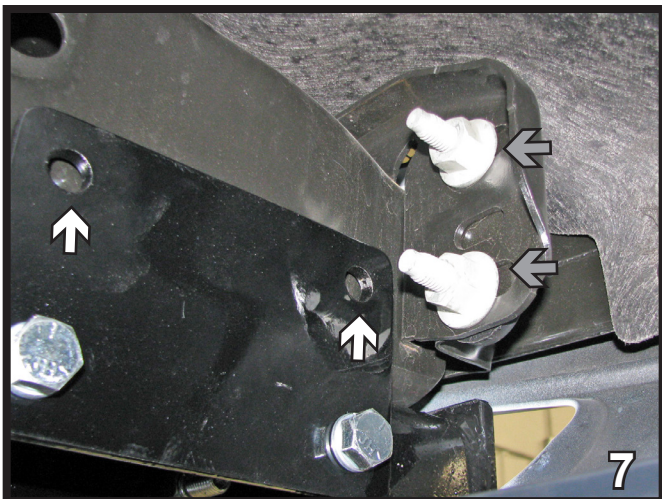

7. Using a 21MM socket remove the two bolts on side up on top (gray arrows). Tap the bolts out of the way for drilling. Using the plate as a template with a 17/32" drill bit, drill the top two holes into the frame (white arrows). Replace the original 21MM nuts. Do this on both sides of the frame and both sides of the vehicle.

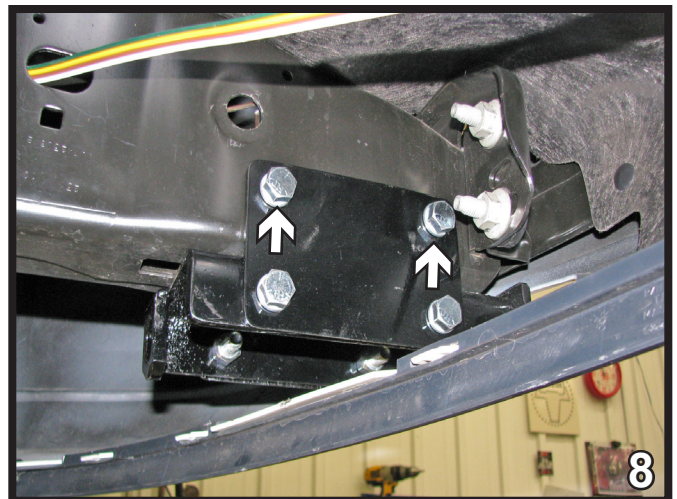

8. Attach the top with 1/2-13 x 1 1/2" bolts, 1/2" lock washers and 1/2-13 whiz nuts with wire. Do this on both sides of the baseplate and both sides of the vehicle.

BX2630
2011-14 Lincoln Navigator
2011-14 Ford F-150 King Ranch/SVT Raptor
Installation Instructions

Lincoln Navigator continued

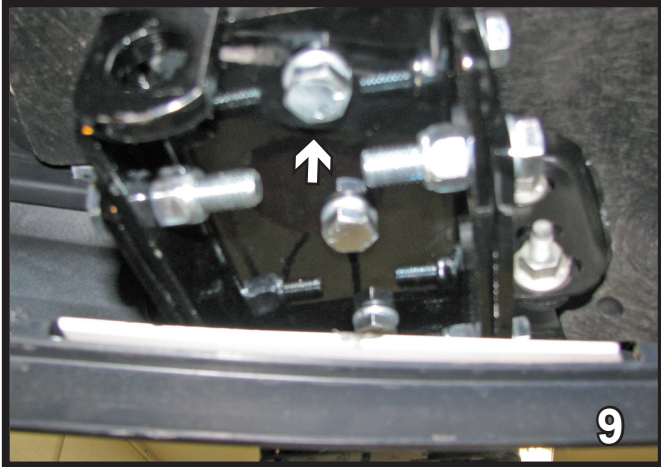

9. Insert a 1/2-13 x 1 1/2" bolt with 1/2" lock washer and 1/2-13 whiz nut with wire into the back bottom hole. Do this on both sides.

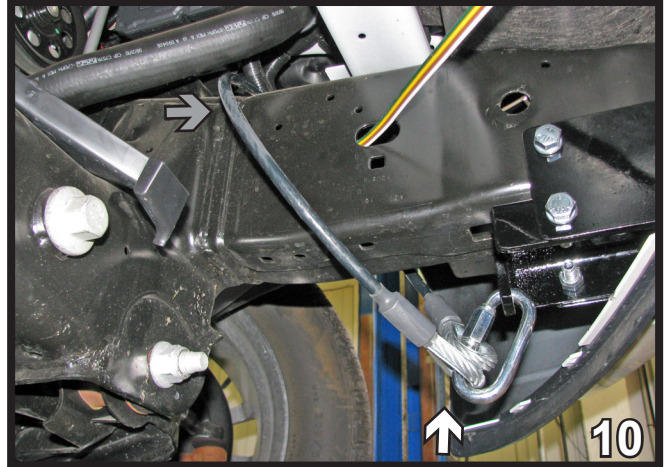

10. Attach the permanent baseplate safety cables to the provided convenience link on the baseplate (white arrow). The photo above shows the recommended installation of the cables to the frame of vehicle (gray arrow). Additional options may interfere with the suggested mounting. In this case, secure the cables to a solid piece of the frame as described in the instructions included with the permanent baseplate safety cables. Be sure the safety cables do not rub against any hoses or moving parts. Do this on both sides of the vehicle.



11. Attach the electrical bracket under the license plate.

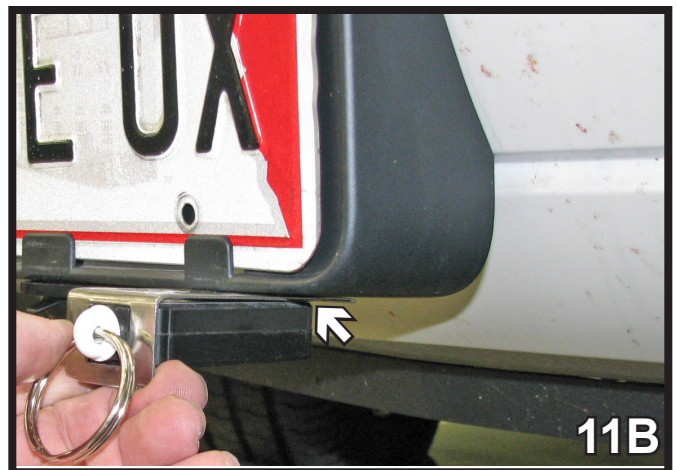
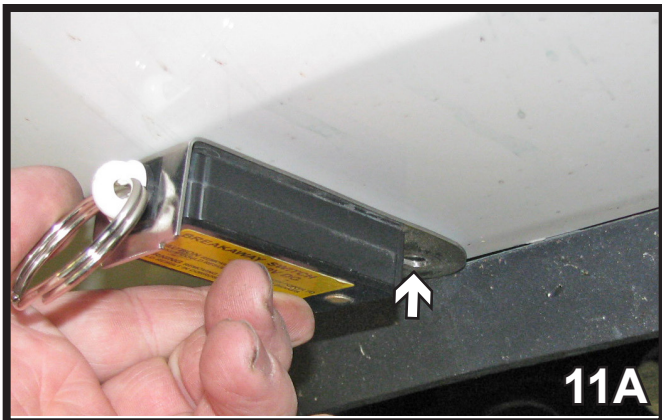

12. **Optional:** The breakaway may either be attached underneath the fascia or under the license plate.

BX2630
2011-14 Lincoln Navigator
2011-14 Ford F-150 King Ranch/SVT Raptor
Installation Instructions

Ford F-150 King Ranch (Includes Eco Boost)

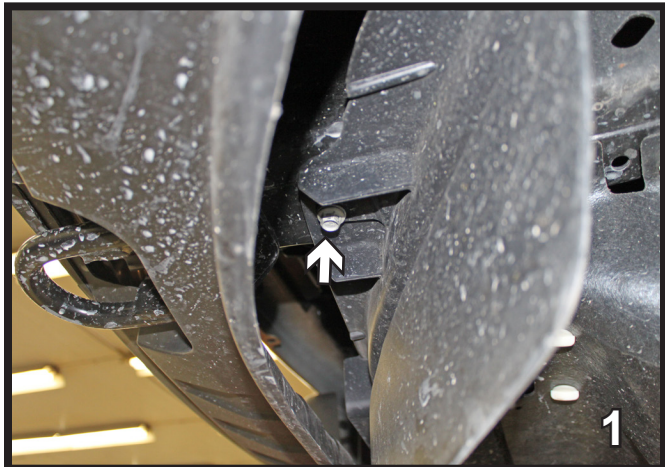

1. Remove the lower air dam underneath the bumper from both sides by removing the bolt behind the tow hooks using a 13MM socket. Remove hex nut clip from frame. Do this on both sides of the vehicle. The lower air dam will not be reinstalled.

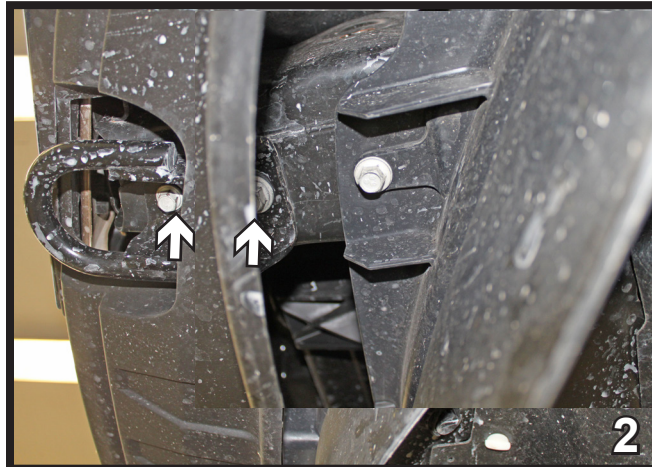

2. Remove the tow hook from both sides by removing the two bolts on the underside of the tow hook using a 15MM socket. Do this on both sides of the vehicle. Set two hooks and bolts aside, they will not be reinstalled.



3. Using a utility knife, trim 1 1/4" back from the outside edge and 1/8" up from the bottom. This will allow access to the bolt on the inside when installing baseplate. Do this to both sides of the vehicle.

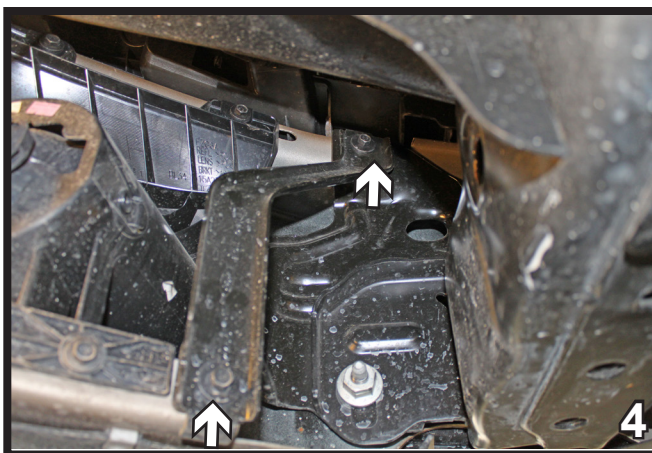

4. Using a 10MM socket, remove two bolts from the bumper support bracket. Do this to both sides. Set the bolts and bracket aside to be reinstalled later.

BX2630
2011-14 Lincoln Navigator
2011-14 Ford F-150 King Ranch/SVT Raptor
Installation Instructions

Ford F-150 King Ranch (Includes Eco Boost)

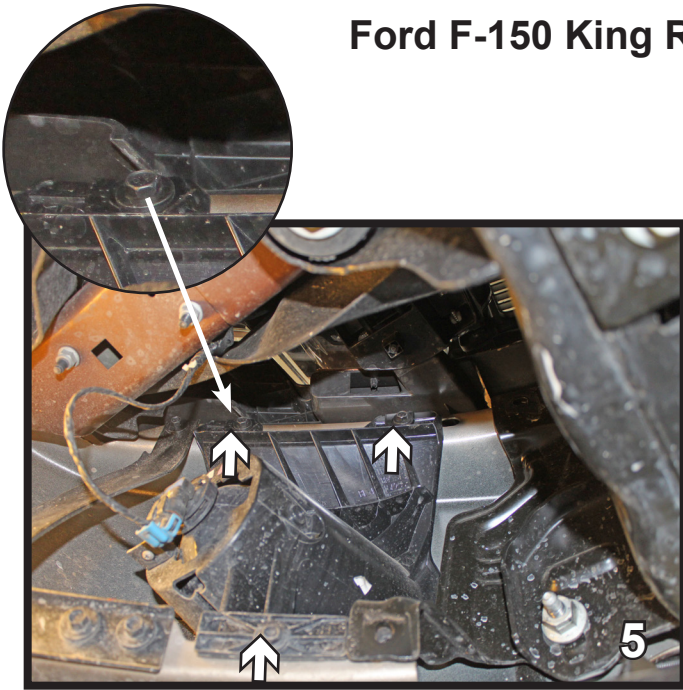

5. Using a 10MM socket, remove three bolts from the fog lights in order to be able to drill. Do this to both sides. Unplug fog lights, set bolts and fog light aside to be reinstalled later.

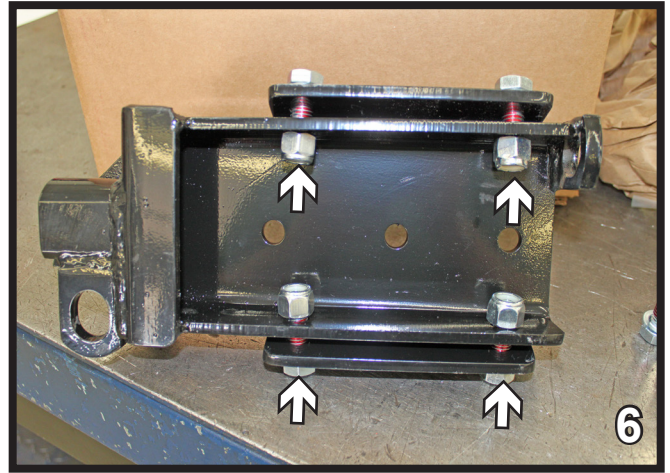

6. Loosely attach the side plates to the baseplate weldment on both sides use 1/2-13 x 1 1/2" hex bolts, 1/2" lock washers and 1/2-13 hex nuts on the inside.

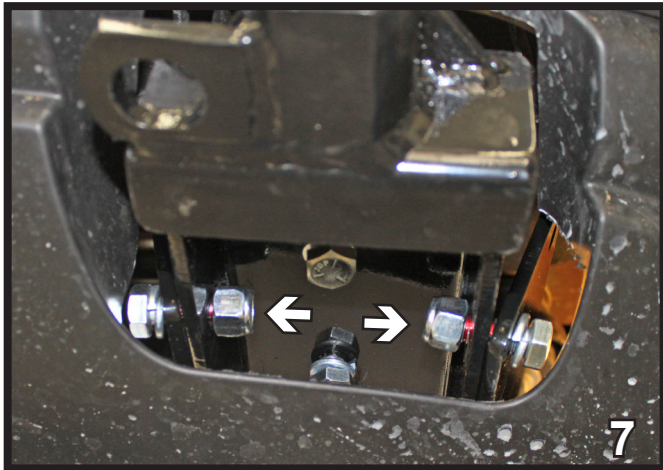

7. Slide the baseplate in place from the back of fascia opening. Align it with the three existing holes on the bottom. The side plates go on the outside of the frame. Do this to both sides of the vehicle.

Be sure to use loctite® red on all bolts before tightening. Tighten all bolts according to the torque chart on the front page of these instructions or on page 3 of the baseplate towing general instructions.

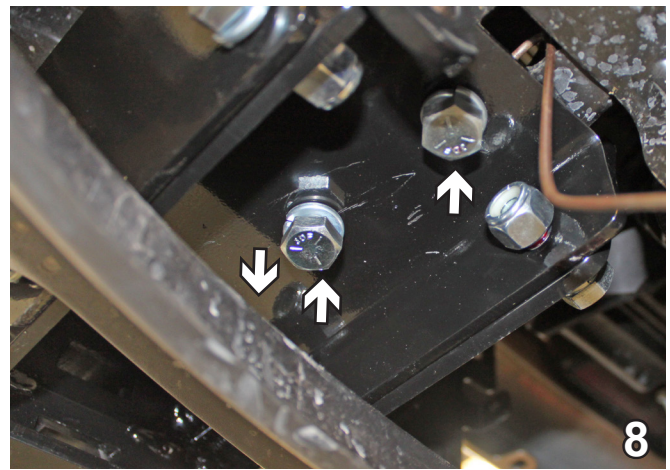

8. Insert 1/2-13 whiz nuts with wire into frame end and hand tighten 1/2-13 x 1 1/2" hex bolts into existing hole for tow hooks. Tighten the side plate fasteners with 3/4" socket and wrench. This will align baseplate with the frame. Then tighten the bottom bolts. Do this to both sides.

BX2630
2011-14 Lincoln Navigator
2011-14 Ford F-150 King Ranch/SVT Raptor
Installation Instructions

Ford F-150 King Ranch (Includes Eco Boost)

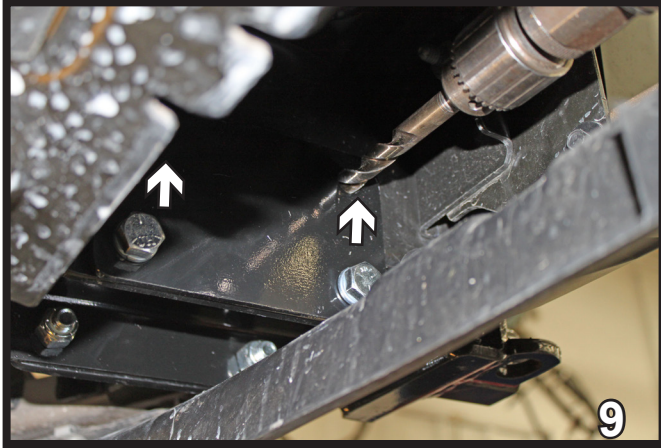

9. Using the side plate as a template with a 17/32" drill bit, drill the top two holes into the frame. Attach the top with 1/2-13 x 1 1/2" bolts, 1/2" lock washers to the 1/2-13 whiz nuts with wire inside the frame. Do this on both sides of the baseplate and both sides of the vehicle (four plates).

When using power drills be aware of the dangers of torque and drill bit length.

11. Reinstall the fog lights and plug back in.
Reinstall the bumper bracket.

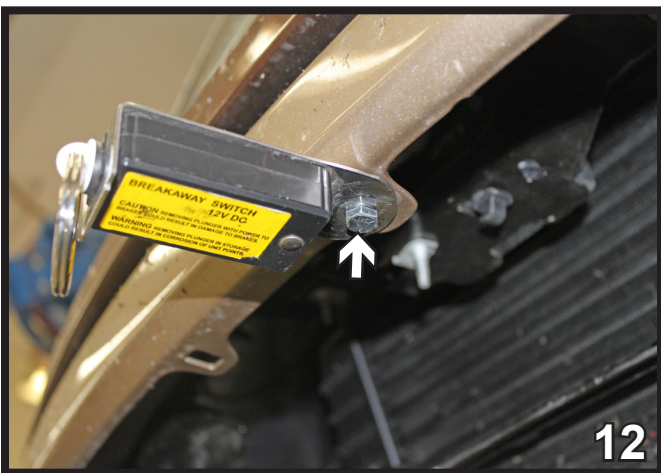

12. **Optional:** Attach the breakaway to the existing hole in the bottom of the bumper. Using a 1/4-20 x 1" hex bolt, 1/4" flat washer and 1/4-20 hex nut. If the license plate bracket is in the middle then drill a hole and attach the breakaway.

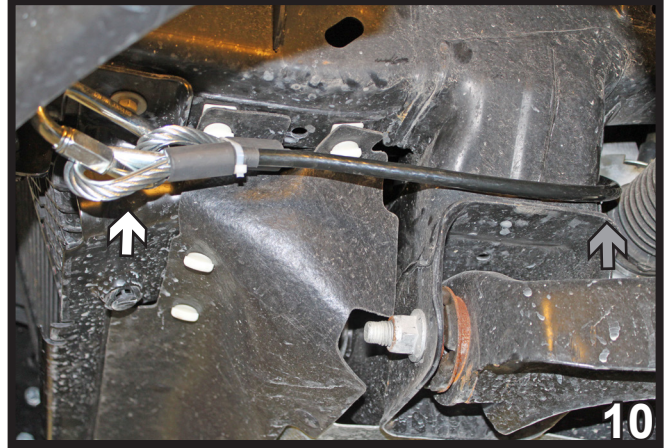

10. Attach the permanent baseplate safety cables to the provided convenience link on the baseplate (white arrow). The photo above shows the recommended installation of the cables to the frame of vehicle (gray arrow). Additional options may interfere with the suggested mounting. In this case, secure the cables to a solid piece of the frame as described in the instructions included with the permanent baseplate safety cables. Be sure the safety cables do not rub against any hoses or moving parts. Do this on both sides of the vehicle.

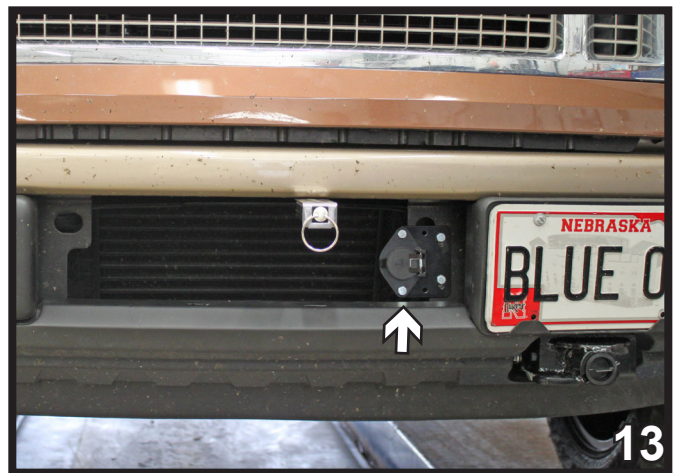

13. Install the electrical bracket to the front fascia.

BX2630
2011-14 Lincoln Navigator
2011-14 Ford F-150 King Ranch/SVT Raptor
Installation Instructions

Be sure that **ALL** electrical connections are plugged in properly and functioning **BEFORE** installing the fascia.

Install the tow bar and safety cables according to the instructions provided in their packages. When demonstrating this to the customer, be sure to give all the contents and packages to the consumer.

Do **NOT** substitute other devices if the tow bar pins and clips are misplaced.



Lincoln shown with removable tabs



King Ranch shown without removable tabs

If the baseplate is in an accident, it must be replaced. **DO NOT** use it again! An accident can cause unseen damage and using it again could result in more damage or serious injury. **DO NOT** use the baseplate if it is damaged or missing parts.

DEALER or INSTALLER:
Be certain the user receives the instruction sheets for their products.

CUSTOMER SERVICE COMMITMENT

Blue Ox is committed to providing you with exceptional customer care throughout your lifetime with our products. Our team is here to assist you with any questions you may have regarding the performance of your product. Simply call (402) 385-3051 and you can speak with our customer care team.

Additionally, please visit our website to see which rallies our Destination America team will be attending. For a nominal fee, our service technician will service your towing system to ensure it's in proper working condition. Also, as a commitment to our customers, should you visit our factory you can stay at our full service Blue Ox campground at no charge along with enjoying a factory tour.

Again, thank you for being our customer and for the confidence you have shown in the performance of our products. It is because of customers like you we enjoy the success we have today.



© 2011 Blue Ox
One Mill Road, Industrial Park
Pender, Nebraska 68047
Phone: (402) 385-3051 • Fax: (402) 385-3360
www.blueox.com

General Information

1. Ensure that your product(s) are registered online at www.blueox.com. It is crucial to register your product(s) so that you may be alerted of product offerings, updates, upgrades, maintenance and safety bulletins, and/or recalls.
2. **It is the owner's responsibility to inspect all towing equipment for cracked welds, missing or worn parts and loose bolts before each towing trip.** Be sure to use Loctite® Red on all bolts and tighten to the recommended specifications.
3. **It is the owner's responsibility to hook up all towing equipment per manufacturer's instructions/recommendations.**
4. Remove the attachment tabs when not in use (if applicable).

Notice To Baseplate Installer

1. It is YOUR responsibility to watch for:

- Oil cooler and air conditioner lines
- Electrical wires and hoses
- Missing parts or attaching points on the frame

** If the baseplate is improperly installed and is against a wire or hose, it could cause fluid leaks or electrical shorts some time after the actual baseplate installation.

Permanent Baseplate Safety Cable Installation

Permanent baseplate safety cables are strongly recommended when towing a vehicle with a tow bar. The principle function of the permanent baseplate safety cables is to prevent the towed vehicle from breaking loose in the event the connection between the frame of the towed vehicle and the baseplate fails or becomes disconnected. The cables must be connected from the baseplate to the frame rail or cross member of the vehicle's frame. The illustrations below show the possible arrangements recommended by Blue Ox®. Each permanent baseplate safety cable must have an adequate weight rating for the towing system. The weight rating of the two (2) cables together will not qualify.

Do not mount the permanent baseplate safety cables against wires, hoses or brake lines.

These permanent baseplate safety cables should remain installed as long as the baseplate is installed on the vehicle. Permanent baseplate safety cables are to be used in conjunction with, and NOT a replacement for legally required safety cables attaching the towed vehicle to the towing vehicle.

OPTION #1

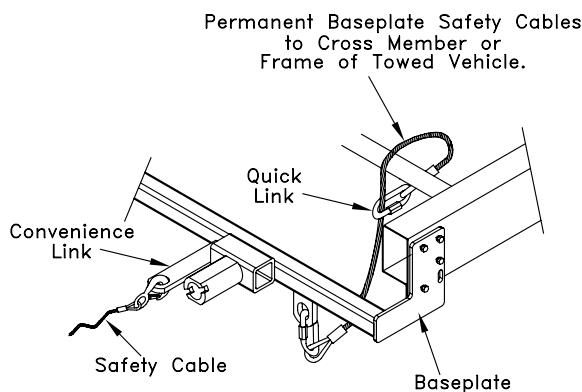

OPTION #2

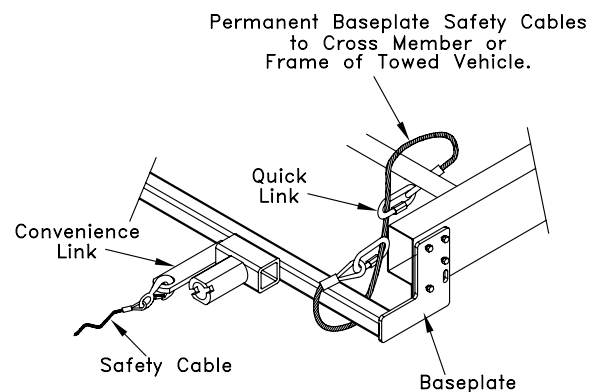

BLUE OX ORIGINAL PURCHASERS THREE YEAR LIMITED WARRANTY

Automatic Equipment Manufacturing Company ("Automatic") warrants to the original (first) retail purchaser that this product, manufactured by Automatic, shall be free from defect in material and workmanship under normal use and service for a period of three years from the date of delivery.

During said three-year period, Automatic will repair or replace any parts that have been returned by the original purchaser, to the factory, transportation prepaid, and in Automatic's sole and absolute opinion found to be defective.

Limitations on Warranty Coverage:

Coverage under this warranty will be valid only if the customer warranty card is returned by the original purchaser within 30 days of purchase.

Coverage under this warranty will be effective only when a copy of the original invoice, showing date and place of purchase, accompanies any claim for warranty. This warranty is NON TRANSFERABLE.

This limited warranty will not cover, in any way or form, any alleged damages caused by incorrect or improper installation, improper use, modification or neglect of product, failure to properly service and maintain, misuse, act of God, accident or failure of the user to follow guidelines contained in the instructional material provided by Automatic.

This warranty does not cover normal wear and tear, paint or rust.

Warrantor assumes no responsibility to the owner for loss of use of product, loss of time, inconvenience or any other damage consequential or otherwise. Including, but not limited to mileage, expense of transporting of product, return shipping expense, mechanics travel time, telephone, road service, towing, and rental during repairs, travel, lodging, loss or damage to personal property or loss of earnings.

REPAIR OR REPLACEMENT AS SET FORTH IN THIS LIMITED WARRANTY IS THE SOLE EXCLUSIVE REMEDY OF THE PURCHASER. AUTOMATIC SHALL NOT BE LIABLE FOR ANY INCIDENTAL OR CONSEQUENTIAL DAMAGES FOR BREACH OF ANY EXPRESS OR IMPLIED WARRANTY ON THIS PRODUCT. EXCEPT TO THE EXTENT PROHIBITED BY APPLICABLE LAW, ANY IMPLIED WARRANTY OF MERCHANTABILITY OR FITNESS FOR A PARTICULAR PURPOSE ON THIS PRODUCT IS LIMITED IN LENGTH TO THE DURATION OF THIS WARRANTY.

Please visit <http://blueox.com/warranty/> to register your warranty

