



# BX2625

## 2011-15 Lincoln MKX (includes Adaptive Cruise Control) Installation Instructions

**Attachment Tab Height: 18-1/4"**

**Attachment Tab Width: 22"**

**Serial Number**

**Please read BOTH these Installation Instructions and the General Information sheet prior to installing or operating this equipment.**

- Blue Ox® towing products and accessories are intended to be installed by Blue Ox® Dealers who are familiar with our products and have the equipment and knowledge necessary to do "fit work". If needed, Blue Ox® Dealers can be found at [www.blueox.com](http://www.blueox.com) or by contacting our Technical Service Department at (402) 385-3051.
- Many Blue Ox® baseplates are designed to use existing holes and hardware to mount the baseplate to the towed vehicle. Even though bolts are there, do not assume they are adequate for baseplate mounting. Always use the hardware supplied in the hardware kit and existing hardware as specified in the installation instructions.

### Bolt Torque Specifications

Torque in Foot-Pounds for Inch Bolts

Bolt Size	Grade 5	Grade 8
1/4"	10	14
5/16"	19	29
3/8"	33	47
7/16"	54	78
1/2"	78	119
5/8"	154	230
3/4"	257	380

### Bolt Torque Specifications

Torque in Foot-Pounds for Metric Bolts

Bolt Size	Grade 8.8	Grade 10.9
6MM	6	8
8MM	16	22
10MM	31	40
12MM	54	70
14MM	89	117
16MM	161	230
18MM	222	318



If the front of your vehicle looks different than this, please contact us at (402)385-3051.

**Reference your vehicle owner's manual for manufacturer's towing specifications.**



## WARNING

Failure to read and follow these instructions could result in separation of the towed vehicle from the tow bar, causing property damage, loss of towed vehicle, personal injury or death.

BX2625  
2011-15 Lincoln MKX (includes Adaptive Cruise Control)  
Installation Instructions

**Instruction Notes:** The fascia, ACC Box, coolant lines and windshield washer fluid reservoir are removed and reinstalled for the baseplate installation. The metal bumper is removed and is not reinstalled. Some drilling and trimming is required.

Place all components that are removed on a flat, sturdy surface. All items will be reinstalled unless otherwise noted after the baseplate is installed.

The dimensional variations between otherwise identical vehicles can be considerable. While the baseplate was designed for easy installation, it may be necessary to tailor the baseplate slightly to compensate for vehicle manufacturer's tolerances.

## ***NOTICE***

- Handling of some cosmetic parts when installing this product may require the use of protective covers, rags, specialty tools, etc. to prevent damage.
- When using power drills be aware of the dangers of torque and drill bit length.
- When using a reciprocating saw be aware of objects behind the cutting surface.
- Use a good quality paint to spray cut edges of frame to prevent rusting.
- Be sure that **ALL** electrical connections are plugged in and accessories are functioning properly before reinstalling the fascia.
- The baseplate is computer tested to your vehicle's GVWR, exceeding this weight will void the manufacturer's warranty.
- Be sure to use a sufficient amount of Loctite® Red on all bolt threads before tightening. Tighten all bolts according to the torque chart provided unless specified.
- Dealer or installer be certain the user receives these instruction sheets.
- If the baseplate is in an accident, it must be replaced. **DO NOT** use it again! An accident can cause unseen damage and using it again could result in more damage or serious injury. **DO NOT** use the baseplate if it is damaged or missing parts.

# BX2625

## 2011-15 Lincoln MKX (includes Adaptive Cruise Control)

### Installation Instructions

#### **Tools Required**

Large Vise Grip  
 Flat Screwdriver  
 Utility Knife  
 Phillips Screwdriver  
 Torque Wrench  
 Drill  
 Reciprocating Saw  
 Tape Measure  
 Loctite® RED  
 1-1/4" Holesaw  
 1/4" Drill Bit  
 13/32" Drill Bit  
 17/32" Bit  
 5.5MM Socket  
 8MM Socket  
 10MM Socket  
 13MM Socket  
 9/16" Socket  
 9/16" Wrench  
 3/4" Wrench  
 3/4" Socket

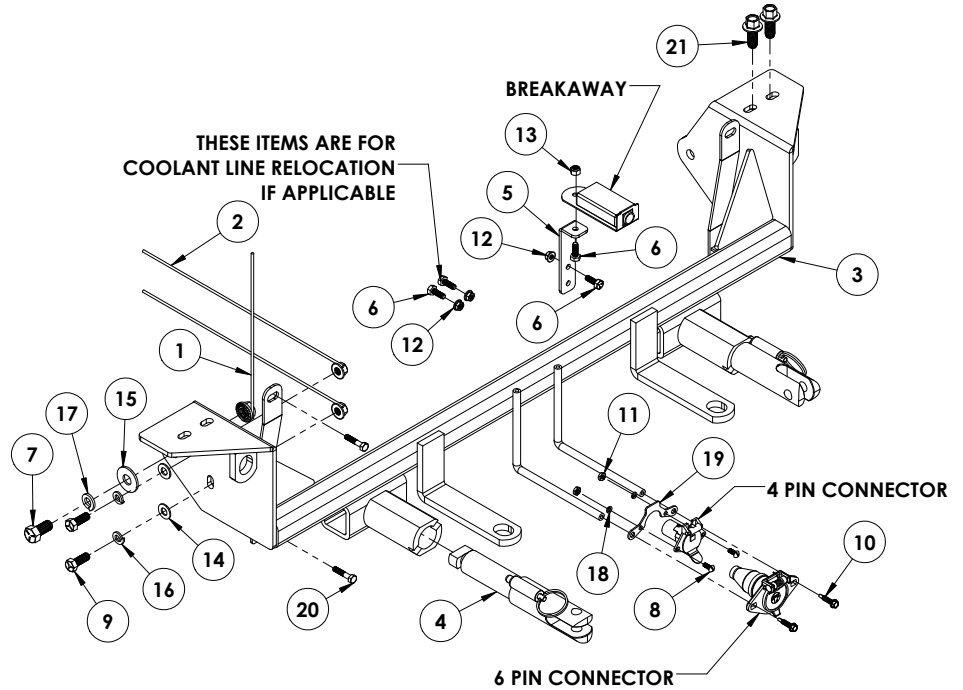

Item No.	Part No.	Description	Qty.
1.....	61-4029 .....	1/2"-13 Whiz Nut w/ 10" Wire .....	2
2.....	61-4978 .....	3/8"-16 Whiz Nut w/ 14" Wire .....	4
3.....	61-6800 .....	BX2625 Baseplate.....	1
4.....	62-3469 .....	Attachment Tab.....	2
5.....	102-7186 .....	Breakaway Bracket .....	1
6.....	201-0050 .....	1/4"-20 x 3/4" Hex Head Bolt, Grade 5, ZP .....	4
7.....	201-0060 .....	1/2"-13 x 1" Hex Head Bolt, Grade 5, ZP .....	2
8.....	201-0192 .....	#10-32 x 1/2" Round Head Screw .....	2
9.....	201-0443 .....	3/8"-16 x 1" Hex Head Bolt, Grade 5, ZP .....	4
10.....	201-0979 .....	#12-14 x 1" Self Drilling Screw, ZP.....	2
11.....	202-0047 .....	#10-32 Hex Nut .....	2
12.....	202-0069 .....	1/4"-20 Hex Whiz Lock Nut .....	3
13.....	202-0102 .....	1/4"-20 Hex Nylon Nut, ZP .....	1
14.....	203-0003 .....	3/8" Flat Washer, ZP.....	4
15.....	203-0005 .....	1/2" Flat Washer, ZP.....	2
16.....	203-0010 .....	3/8" Lock Washer, ZP .....	4
17.....	203-0012 .....	1/2" Lock Washer, ZP .....	2
18.....	203-0054 .....	#10 Lock Washer.....	2
19.....	299-0685 .....	4-Way Bracket.....	1
20.....	Existing.....	Face Bumper Bolt.....	4
21.....	Existing.....	Top Bumper Bolt.....	4
22.....	226-0049(not shown) .....	36" Class IV Safety Cable .....	2
23.....	229-0512(not shown) .....	1/2" Quick Link, ZP .....	4
24.....	290-0437(not shown) .....	Black Cap Plug Receiver.....	2

#### **Important:**

Use only genuine factory replacement parts on your baseplate. Do **NOT** substitute homemade or non-typical parts. If a bolt is lost or in need of replacement, for your safety and the preservation of your baseplate, be sure to use a replacement bolt of the same grade (In most cases it will be Grade 5, please reference the parts list above). Replacement parts may be ordered through your nearest Blue Ox® Dealer or Distributor. Failing to follow and/or altering these installation instructions in either installation or required equipment will void the manufacturer's warranty. Towing behind a non-motorized vehicle will void the warranty.



BX2625  
2011-15 Lincoln MKX (includes Adaptive Cruise Control)  
Installation Instructions

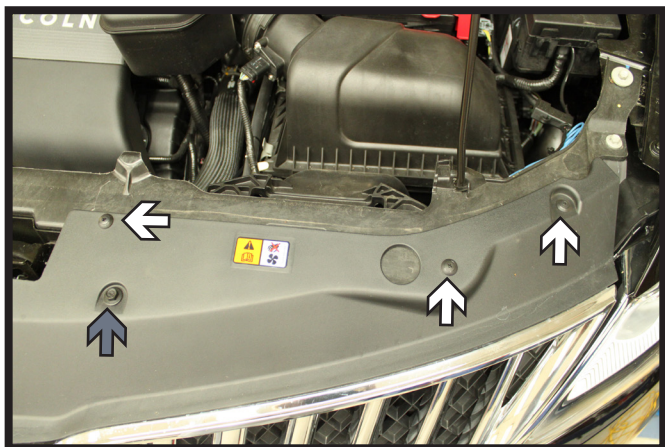

1. Remove the three (3) push pins (white) and then, using a 10MM socket, remove the one (1) screw (gray) from the plastic radiator cover. Do this to both sides of the vehicle.



2. Using a 5.5MM socket, remove the three (3) screws just forward of the front tire in the wheel well. Do this to both sides of the vehicle.



3. Using a 5.5MM socket, remove the two (2) screws from underneath the front edge of fascia. Do this to both sides of the vehicle.

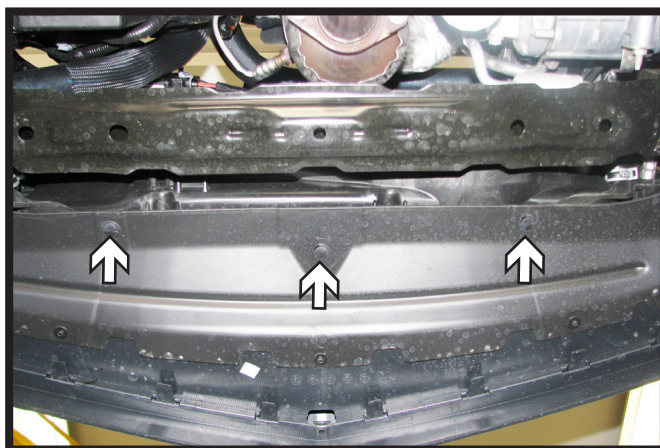

4. Remove the three (3) push pins that are located in the center of vehicle on the underside of the fascia. Then on the corners of the fascia pull out to the side and forward to remove. Set fascia aside.



BX2625  
2011-15 Lincoln MKX (includes Adaptive Cruise Control)  
Installation Instructions

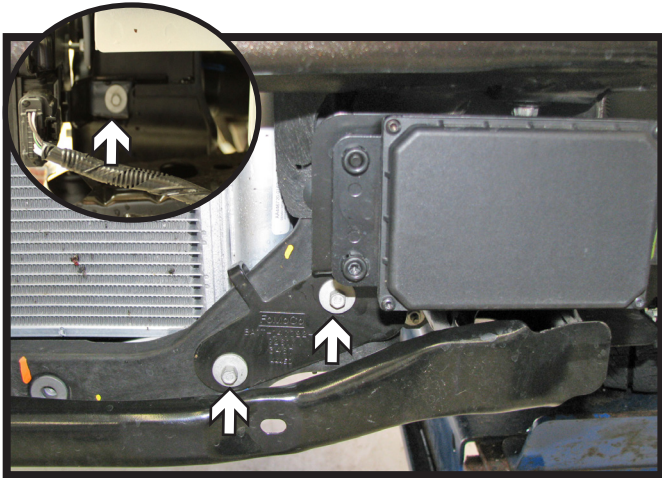

5. If vehicle is equipped with ACC, on the drivers side only, using an 8mm socket remove the two (2) bolts from the front and the one (1) on the back side of the cruise control box.

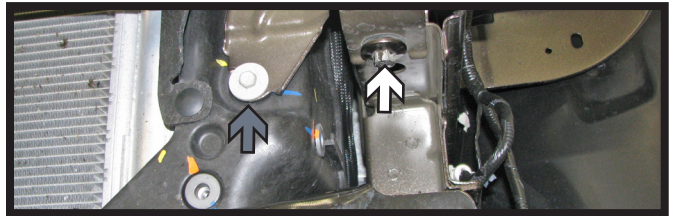
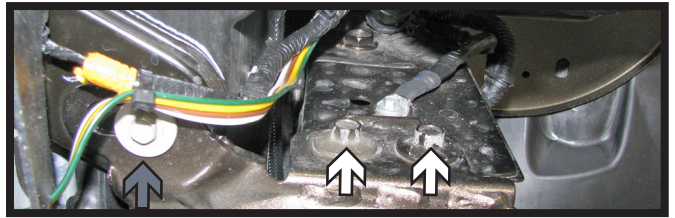

6. Using a 13MM socket, remove the two (2) bolts from the top of the metal bumper and one (1) bolt from the bottom (white). Then using a 10MM socket, remove the one (1) bolt from the top and bottom of the bumper (gray). Do this to both sides of the vehicle. Remove the metal bumper from the vehicle, the bumper will not be reinstalled later.

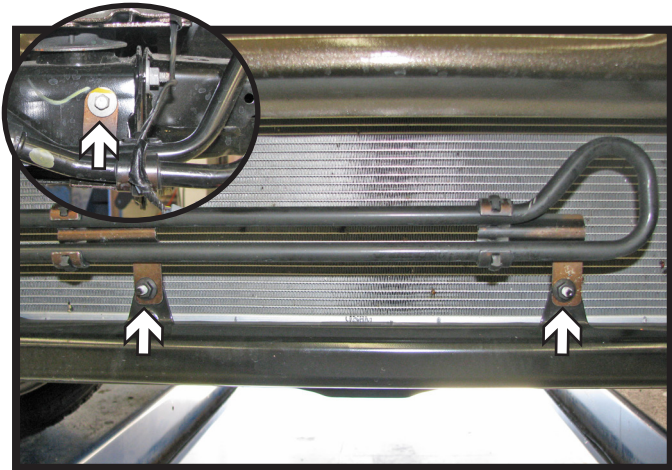

7. On the passenger side front of the vehicle, using a 10MM socket remove the two (2) bolts (white) from the lower coolant line. Then using a 8MM socket, remove the one (1) bolt (gray) located on the side of the vehicle. The lower coolant line now can be swung out of the way.

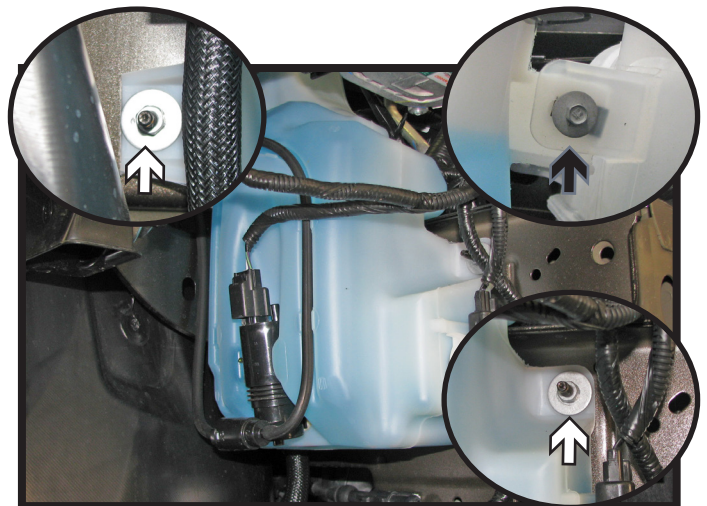

8. On the passengers side, using an 8MM socket remove the bolt on the top (black). With the 10MM socket remove the two (2) nuts on either side (white). Unplug the hoses and electrical lines and remove the washer fluid reservoir.



BX2625  
2011-15 Lincoln MKX (includes Adaptive Cruise Control)  
Installation Instructions

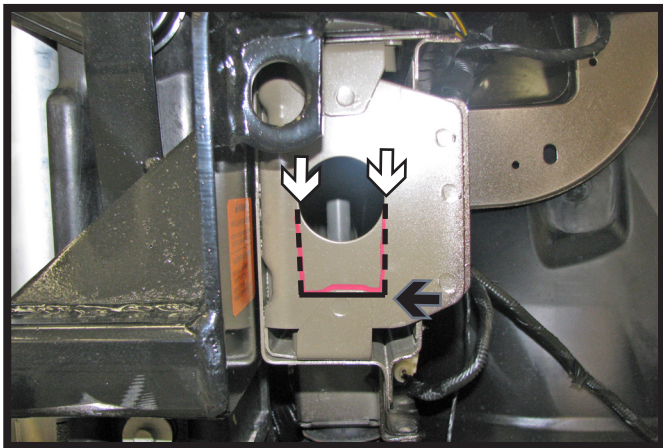

9. Using a reciprocating saw, make the two (2) vertical cuts (white) to approximately the bend line (black). Bend the cut area into the frame end and as far down as possible. Do this to both sides of the vehicle.



10. Using a reciprocating saw, cut off the tabs that the lower coolant line were attached to, being careful not to cut into the radiator.

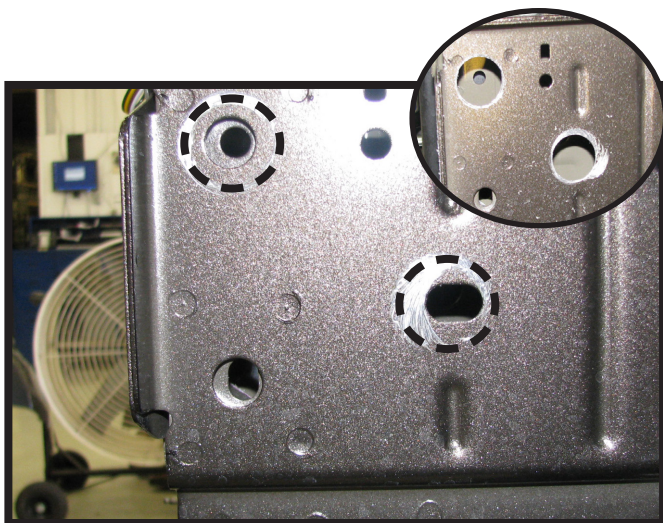

11. Using a 1 1/4" hole saw, drill two (2) 1-1/4" holes into the frame, utilizing the two (2) existing holes in the side of the frame. This gives an access hole to tighten fasteners. Do this to both sides of the vehicle.

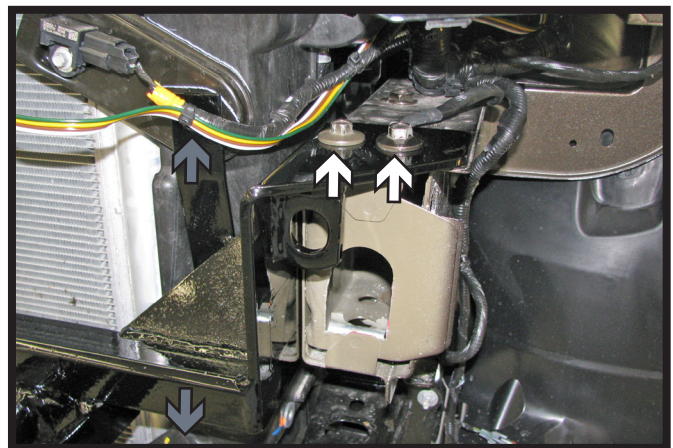

12. Place baseplate on top of frame and line up the holes in the baseplate with the two (2) existing holes on top of the frame. Reinstall the four (4) existing bolts from step 6, two (2) on the top (white) and (2) on the face (grey). Do this to both sides of the vehicle.



## BX2625

### 2011-15 Lincoln MKX (includes Adaptive Cruise Control) Installation Instructions

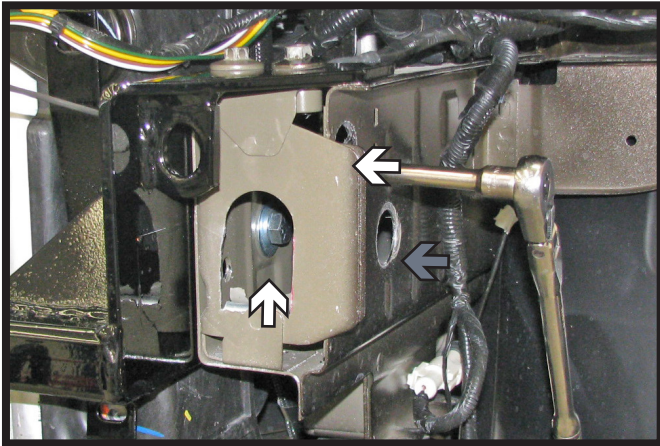

13. Align lower base plate holes to the existing holes. They may need to be reamed out using a 13/32" or 17/32" drill bit. Install a 3/8"-16 x 1" bolt, 3/8" lock washer, 3/8" flat washer and a 3/8" nut w/wire into the front holes and tighten down (white). Then install a 1/2"-13 x 1" bolt, 1/2" lock washer, 1/2" flat washer and a 1/2" nut plate into rear hole (gray). Do this to both sides of the vehicle.

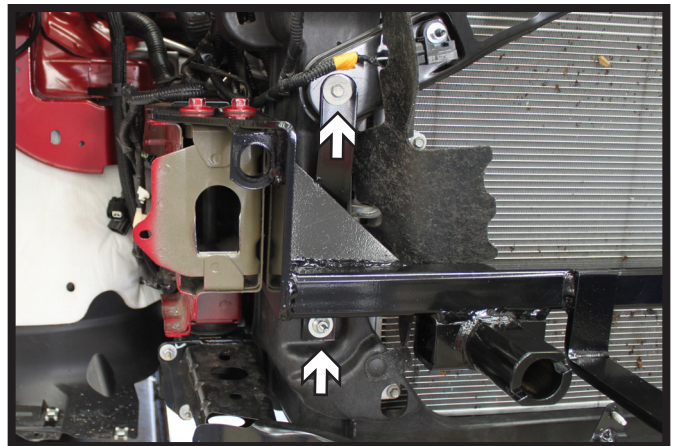

14. Reinstall the existing bolts to the top and bottom of the radiator support. Do this on both sides of the vehicle.

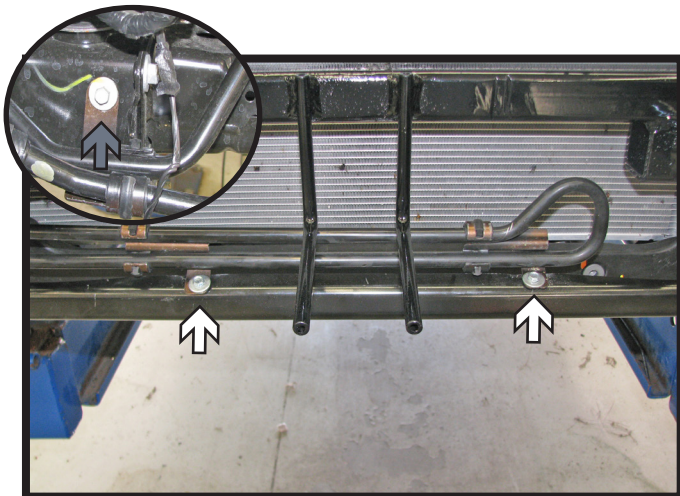

15. Remove coolant line brackets from the back side and relocate to the front of the coolant line. Using the bracket as a template, drill 1/4" holes into the lower cross member and install 1/4"-20 x 3/4" bolts and 1/4"-20 nuts on the back side of the cross member (white). Reinstall the bolt located on the side of the vehicle for the lower coolant line (gray).

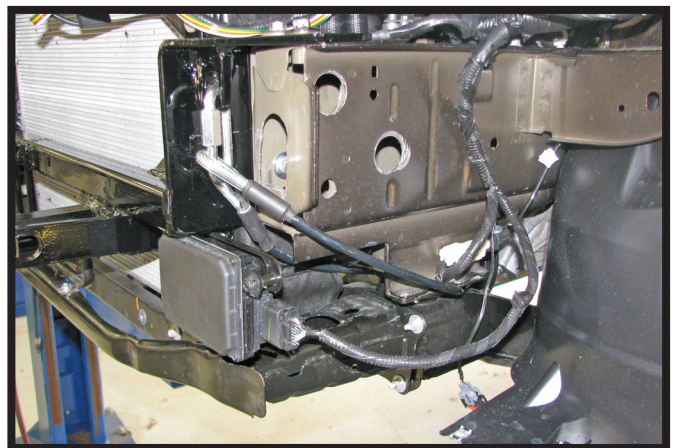

16. Attach the permanent baseplate safety cables to the provided convenience link on the baseplate. The photo beside shows the recommended installation of the cables to frame of vehicle. Additional options may interfere with suggested mounting; in this case, secure the cables to a solid piece of the frame as described in the instructions included with the permanent baseplate safety cables. Be sure the safety cables do not rub against any hoses or moving parts. Do this on **BOTH** sides of the vehicle.

BX2625  
2011-15 Lincoln MKX (includes Adaptive Cruise Control)  
Installation Instructions

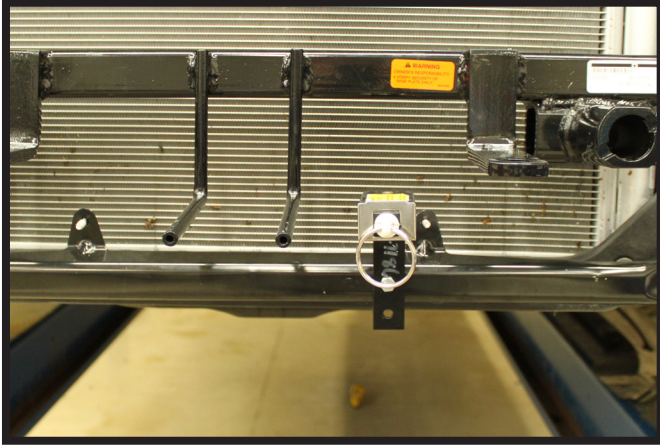

17. **OPTIONAL:** Install the breakaway bracket and breakaway on the driver's side of the vehicle between the convenience link and electrical rods. Drill a 1/4" hole into the frame located below the radiator. Attach the bracket to frame of vehicle with 1/4"-20 x 3/4" bolt and 1/4"-20 nylon nut. Attach the breakaway to the bracket with a 1/4"-20 x 3/4" bolt and 1/4"-20 locking nut.

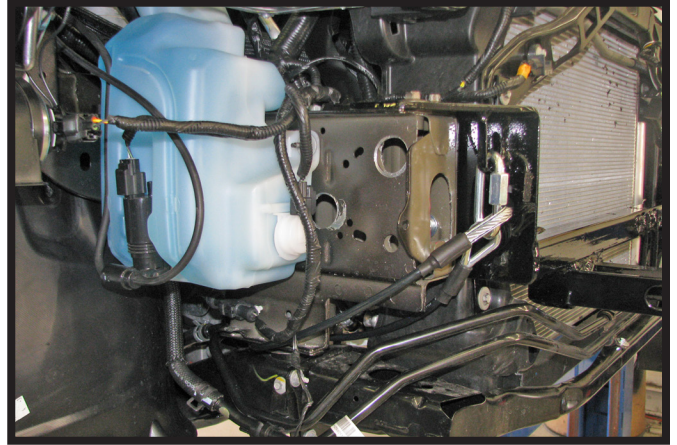

18. Reinstall the washer fluid reservoir, cruise control box. Hold the fascia as close to its original position. Mark and trim for the attachment tabs and convenience links. Reinstall the fascia.

## CUSTOMER SERVICE COMMITMENT

Blue Ox® is committed to providing you with exceptional customer care throughout your lifetime with our products. Our team is here to assist you with any questions you may have regarding the performance of your product. Simply call (402) 385-3051 and you can speak with our technical service team.

Additionally, please visit our website to see which rallies our Destination America team will be attending. For a nominal fee, our service technician will service your towing system to ensure it's in proper working condition. Also, as a commitment to our customers, should you visit our factory, you can stay at our full service Blue Ox® campground at no charge along with enjoying a factory tour.

Again, thank you for being our customer and for the confidence you have shown in the performance of our products. It is because of customers like you we enjoy the success we have today.



# General Information

1. Ensure that your product(s) are registered online at [www.blueox.com](http://www.blueox.com). It is crucial to register your product(s) so that you may be alerted of product offerings, updates, upgrades, maintenance and safety bulletins, and/or recalls.
2. **It is the owner's responsibility to inspect all towing equipment for cracked welds, missing or worn parts and loose bolts before each towing trip.** Be sure to use Loctite® Red on all bolts and tighten to the recommended specifications.
3. **It is the owner's responsibility to hook up all towing equipment per manufacturer's instructions/recommendations.**
4. Remove the attachment tabs when not in use (if applicable).

## Notice To Baseplate Installer

### 1. It is YOUR responsibility to watch for:

- Oil cooler and air conditioner lines
- Electrical wires and hoses
- Missing parts or attaching points on the frame

\*\* If the baseplate is improperly installed and is against a wire or hose, it could cause fluid leaks or electrical shorts some time after the actual baseplate installation.

## Permanent Baseplate Safety Cable Installation

Permanent baseplate safety cables are strongly recommended when towing a vehicle with a tow bar. The principle function of the permanent baseplate safety cables is to prevent the towed vehicle from breaking loose in the event the connection between the frame of the towed vehicle and the baseplate fails or becomes disconnected. The cables must be connected from the baseplate to the frame rail or cross member of the vehicle's frame. The illustrations below show the possible arrangements recommended by Blue Ox®. Each permanent baseplate safety cable must have an adequate weight rating for the towing system. The weight rating of the two (2) cables together will not qualify.

***Do not mount the permanent baseplate safety cables against wires, hoses or brake lines.***

These permanent baseplate safety cables should remain installed as long as the baseplate is installed on the vehicle. Permanent baseplate safety cables are to be used in conjunction with, and NOT a replacement for legally required safety cables attaching the towed vehicle to the towing vehicle.

### Option #1

(Baseplates with Convenience Link Tabs)



### Option #2

(Baseplates with out Convenience Link Tabs)



# BLUE OX ORIGINAL PURCHASERS THREE YEAR LIMITED WARRANTY

Automatic Equipment Manufacturing Company ("Automatic") warrants to the original (first) retail purchaser that this product, manufactured by Automatic, shall be free from defect in material and workmanship under normal use and service for a period of three years from the date of delivery.

During said three-year period, Automatic will repair or replace any parts that have been returned by the original purchaser, to the factory, transportation prepaid, and in Automatic's sole and absolute opinion found to be defective.

Limitations on Warranty Coverage:

Coverage under this warranty will be valid only if the customer warranty card is returned by the original purchaser within 30 days of purchase.

Coverage under this warranty will be effective only when a copy of the original invoice, showing date and place of purchase, accompanies any claim for warranty. This warranty is NON TRANSFERABLE.

This limited warranty will not cover, in any way or form, any alleged damages caused by incorrect or improper installation, improper use, modification or neglect of product, failure to properly service and maintain, misuse, act of God, accident or failure of the user to follow guidelines contained in the instructional material provided by Automatic.

This warranty does not cover normal wear and tear, paint or rust.

Warrantor assumes no responsibility to the owner for loss of use of product, loss of time, inconvenience or any other damage consequential or otherwise. Including, but not limited to mileage, expense of transporting of product, return shipping expense, mechanics travel time, telephone, road service, towing, and rental during repairs, travel, lodging, loss or damage to personal property or loss of earnings.

**REPAIR OR REPLACEMENT AS SET FORTH IN THIS LIMITED WARRANTY IS THE SOLE EXCLUSIVE REMEDY OF THE PURCHASER. AUTOMATIC SHALL NOT BE LIABLE FOR ANY INCIDENTAL OR CONSEQUENTIAL DAMAGES FOR BREACH OF ANY EXPRESS OR IMPLIED WARRANTY ON THIS PRODUCT. EXCEPT TO THE EXTENT PROHIBITED BY APPLICABLE LAW, ANY IMPLIED WARRANTY OF MERCHANTABILITY OR FITNESS FOR A PARTICULAR PURPOSE ON THIS PRODUCT IS LIMITED IN LENGTH TO THE DURATION OF THIS WARRANTY.**

Please visit <http://blueox.com/warranty/> to register your warranty

