



# BX2617

## 2009-12 Lincoln MKS 2010-12 Lincoln MKT

### Installation Instructions

**Attachment Tab Height: 13"**

**Attachment Tab Width: 22"**

**Serial Number**

**Please read BOTH these Installation Instructions and the General Information sheet prior to installing or operating this equipment.**

1. Blue Ox® towing products and accessories are intended to be installed by Blue Ox® Dealers who are familiar with our products and have the equipment and knowledge necessary to do "fit work". If needed, Blue Ox® Dealers can be found at [www.blueox.com](http://www.blueox.com) or by contacting our Technical Service Department at (402) 385-3051.
2. Many Blue Ox® baseplates are designed to use existing holes and hardware to mount the baseplate to the towed vehicle. Even though bolts are there, do not assume they are adequate for baseplate mounting. Always use the hardware supplied in the hardware kit and existing hardware as specified in the installation instructions.

#### Bolt Torque Specifications

Torque in Foot-Pounds for Inch Bolts

Bolt Size	Grade 5	Grade 8
1/4"	10	14
5/16"	19	29
3/8"	33	47
7/16"	54	78
1/2"	78	119
5/8"	154	230
3/4"	257	380

#### Bolt Torque Specifications

Torque in Foot-Pounds for Metric Bolts

Bolt Size	Grade 8.8	Grade 10.9
6MM	6	8
8MM	16	22
10MM	31	40
12MM	54	70
14MM	89	117
16MM	161	230
18MM	222	318



If the front of your vehicle looks different than this, please contact us at (402)385-3051.

**Reference your vehicle owner's manual for manufacturer's towing specifications.**

## WARNING

Failure to read and follow these instructions could result in separation of the towed vehicle from the tow bar, causing property damage, loss of towed vehicle, personal injury or death.

BX2617  
2009-12 Lincoln MKS  
2010-12 Lincoln MKT  
Installation Instructions

**Instruction Notes:** The fascia, horn, washer reservoir and plastic cover are removed and reinstalled for the baseplate installation. Some drilling and trimming is required.

Place all components that are removed on a flat, sturdy surface. All items will be reinstalled unless otherwise noted after the baseplate is installed.

The dimensional variations between otherwise identical vehicles can be considerable. While the baseplate was designed for easy installation, it may be necessary to tailor the baseplate slightly to compensate for vehicle manufacturer's tolerances.

The BX8848 4-Diode Wiring Kit is recommended for this vehicle.

## ***NOTICE***

- Handling of some cosmetic parts when installing this product may require the use of protective covers, rags, specialty tools, etc. to prevent damage.
- When using power drills be aware of the dangers of torque and drill bit length.
- When using a reciprocating saw be aware of objects behind the cutting surface.
- Use a good quality paint to spray cut edges of frame to prevent rusting.
- Be sure that **ALL** electrical connections are plugged in and accessories are functioning properly before reinstalling the fascia.
- The baseplate is computer tested to your vehicle's GVWR, exceeding this weight will void the manufacturer's warranty.
- Be sure to use a sufficient amount of Loctite® Red on all bolt threads before tightening. Tighten all bolts according to the torque chart provided unless specified.
- Dealer or installer be certain the user receives these instruction sheets.
- If the baseplate is in an accident, it must be replaced. **DO NOT** use it again! An accident can cause unseen damage and using it again could result in more damage or serious injury. **DO NOT** use the baseplate if it is damaged or missing parts.

**BX2617**  
**2009-12 Lincoln MKS**  
**2010-12 Lincoln MKT**  
**Installation Instructions**

**Tools Required**

Large Vise Grip  
 Flat Screwdriver  
 Utility Knife  
 Phillips Screwdriver  
 Torque Wrench  
 Drill  
 Tape Measure  
 Loctite® RED  
 13/32" Drill Bit  
 5.5MM Socket  
 8MM Socket  
 10MM Socket  
 9/16" Socket  
 9/16" Wrench

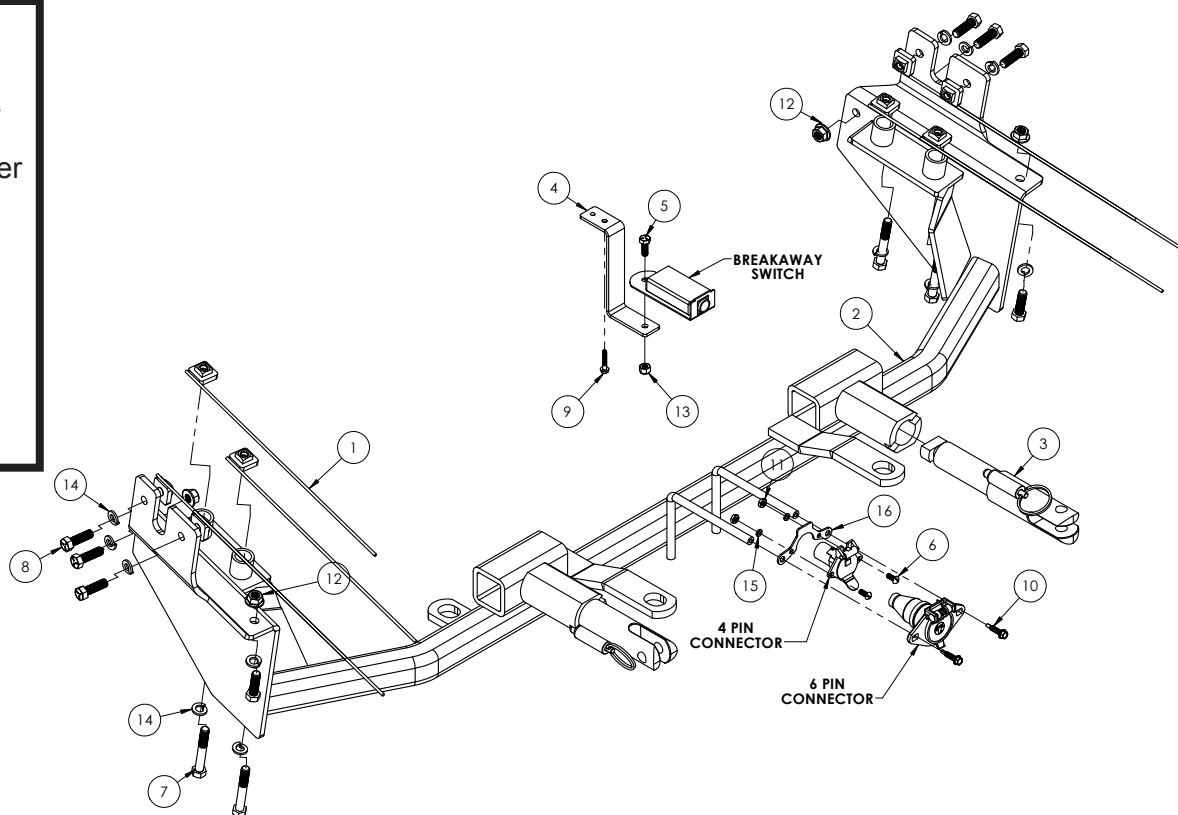

Item No.	Part No.	Description	Qty.
1.....	61-5208 .....	3/8"-16 Nut Plate Weldment with 14" Wire .....	8
2.....	61-6721 .....	BX2617 Baseplate.....	1
3.....	62-3469 .....	Attachment Tab Assembly with Hole .....	2
4.....	102-7197 .....	BX2800 Breakaway Bracket.....	1
5.....	201-0050 .....	1/4"-20 x 3/4" Hex Head Bolt, Grade 5, ZP .....	1
6.....	201-0192 .....	#10-32 1/2" Round Head Slotted Screw.....	2
7.....	201-0336 .....	3/8"-16 x 2-1/2" Hex Head Bolt, Grade 5, ZP .....	4
8.....	201-0368 .....	3/8"-16 x 1-1/4" Hex Head Bolt, Grade 5, ZP .....	8
9.....	201-0654 .....	#10-16 x 1" Self Tapping Screw, ZP .....	1
10.....	201-0979 .....	#12-14 x 1" Self Drilling Screw, ZP.....	2
11.....	202-0047 .....	#10-32 Hex Nut .....	2
12.....	202-0071 .....	3/8"-16 Hex Flange Nut, ZP.....	4
13.....	202-0102 .....	1/4"-20 Hex Nylon Insert Nut, ZP .....	1
14.....	203-0010 .....	3/8" Lock Washer, ZP .....	12
15.....	203-0054 .....	#10 Lock Washer .....	2
16.....	299-0685 .....	4-Way Bracket.....	1
17.....	226-0049 (not shown) .....	36" Class IV Baseplate Safety Cable .....	2
18.....	229-0512 (not shown) .....	1/2" Quicklink, ZP .....	4
19.....	290-0437 (not shown) .....	Receiver Cap Plug .....	2

**Important:**

Use only genuine factory replacement parts on your baseplate. Do **NOT** substitute homemade or non-typical parts. If a bolt is lost or in need of replacement, for your safety and the preservation of your baseplate, be sure to use a replacement bolt of the same grade (In most cases it will be Grade 5, please reference the parts list above). Replacement parts may be ordered through your nearest Blue Ox® Dealer or Distributor. Failing to follow and/or altering these installation instructions in either installation or required equipment will void the manufacturer's warranty. Towing behind a non-motorized vehicle will void the warranty.

BX2617  
2009-12 Lincoln MKS  
2010-12 Lincoln MKT  
Installation Instructions

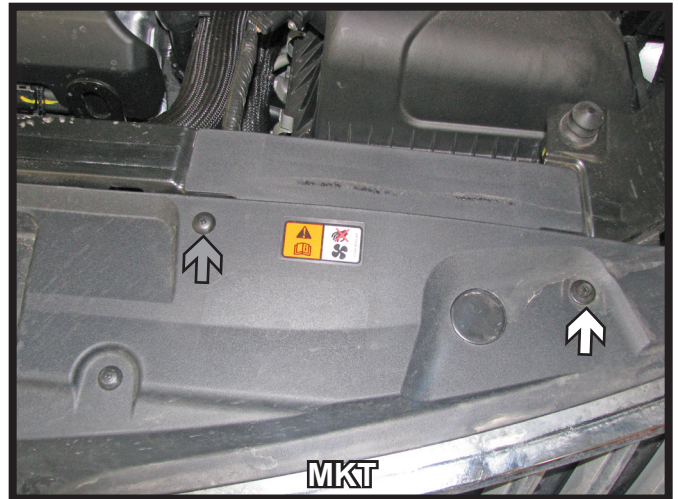
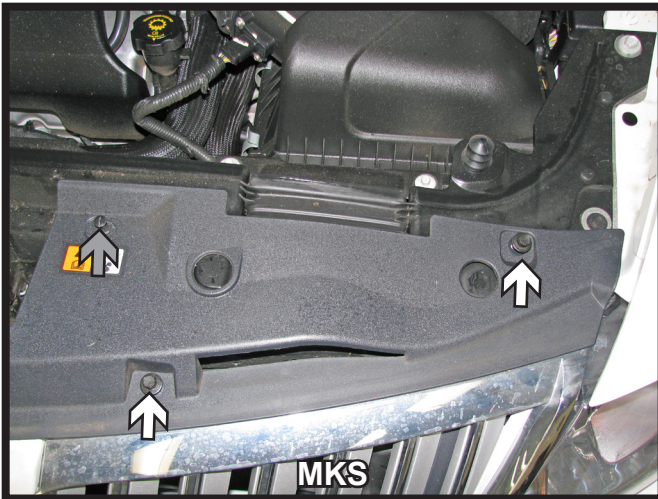

1. **MKS** models: Using a 10MM socket, remove the two (2) bolts (white arrows) from the top of the fascia on both sides of the vehicle. Use a flat screwdriver to remove the push pin in the center (grey arrow). Set bolts and push pins aside to be reinstalled later.

**MKT** models: Using a 10MM socket, remove the bolt (white arrow) from the top of the fascia on both sides of the vehicle. Use a phillips screwdriver to remove the two (2) push pins (gray arrows).

Set bolts and push pins aside to be reinstalled later.



2. **MKS** models: Using a phillips screwdriver, remove the four (4) screws that are located just forward of the front tire on both sides of the vehicle. Set screws aside to be reinstalled later.

**MKT** models: Using a 5.5MM socket, remove the three (3) bolts that are located just forward of the front tire on both sides of the vehicle.

Set bolts aside to be reinstalled later.

BX2617  
2009-12 Lincoln MKS  
2010-12 Lincoln MKT  
Installation Instructions

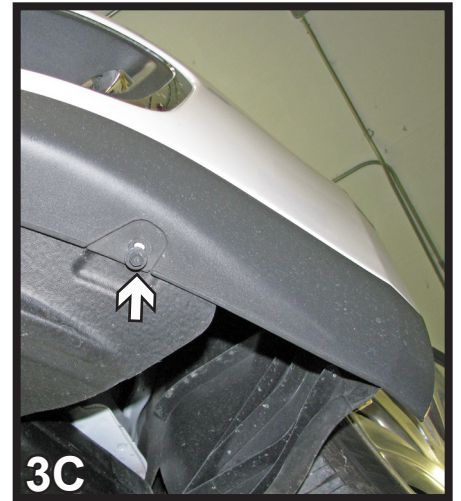
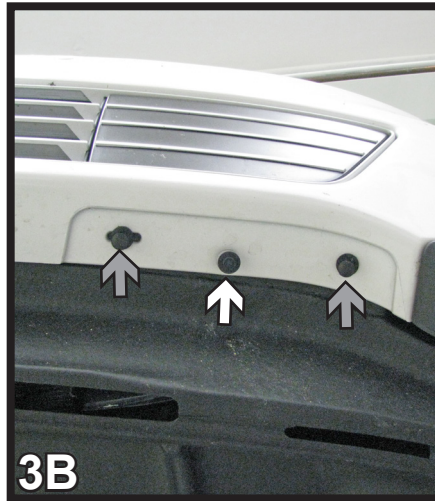
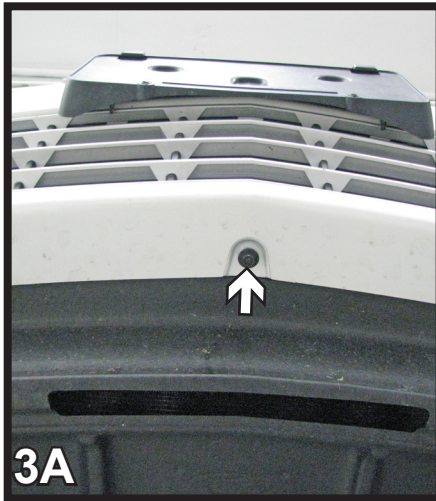

3. **MKS models:** On the underside use an 8MM socket to remove the bolts (white arrows). There is one (1) bolt on the outermost edges of the fascia, figure 3C, one (1) directly in the center, figure 3A, and also one (1) between the push pins, figure 3B.

Remove the push pins (grey arrows) that are located on each side of the bolt, figure 3B with a flat screwdriver. Pull fascia corners out to the side of the vehicle, then pull forward.

Set fascia, bolts and screws aside carefully to be reinstalled later.

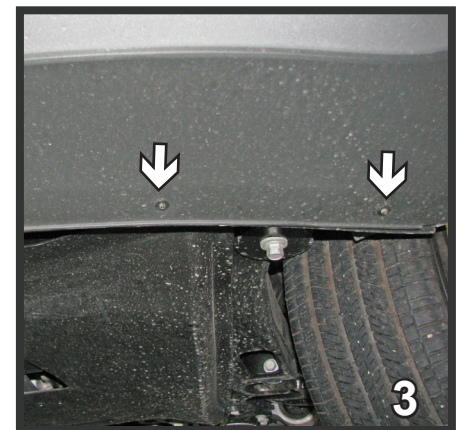
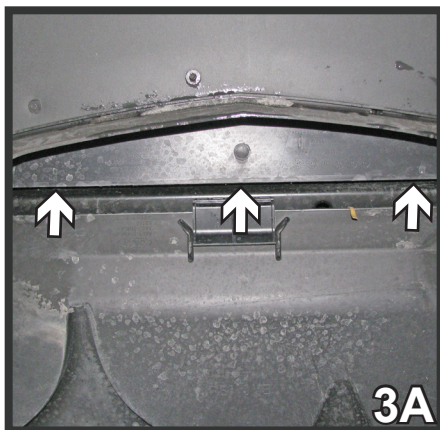

3. **MKT models:** In front underneath, remove three push pins from the center. Using a 5.5MM socket, remove one bolt on each side (gray arrow). Pull fascia corners out to the side of the vehicle to unsnap, then pull forward. Set fascia, pins and bolts aside carefully to be reinstalled later.

3. **MKT models:** In front underneath, using a 5.5MM socket remove seven bolts. Pull fascia corners out to the side of the vehicle, then pull forward. Set fascia and bolts aside carefully to be reinstalled later.

BX2617  
 2009-12 Lincoln MKS  
 2010-12 Lincoln MKT  
 Installation Instructions

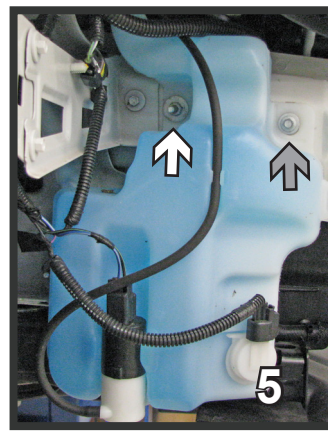
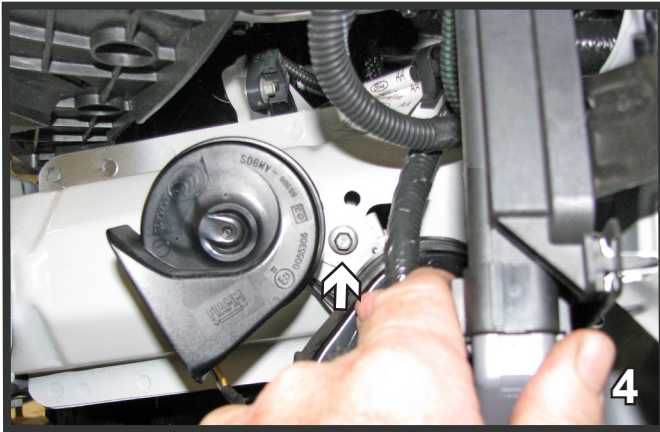

4. On the driver's side, using an 8MM socket, remove the bolt holding the horn. Set the horn and bolt down by the side to be reinstalled later.
5. **MKS models:** On the passenger side, using an 8MM socket remove the bolt from the top right side (gray arrow). Using an 11MM socket, remove the two bolts on the left side (white arrows). Unhook hoses and wires. Set washer reservoir and bolts aside to be reinstalled later.  
**MKT models:** Use a 10MM socket to remove all three bolts.

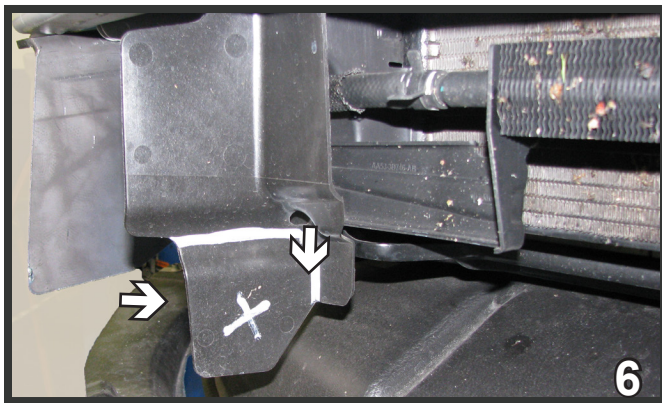

6. **MKS models:** On the passenger side, trim across the groove and down.

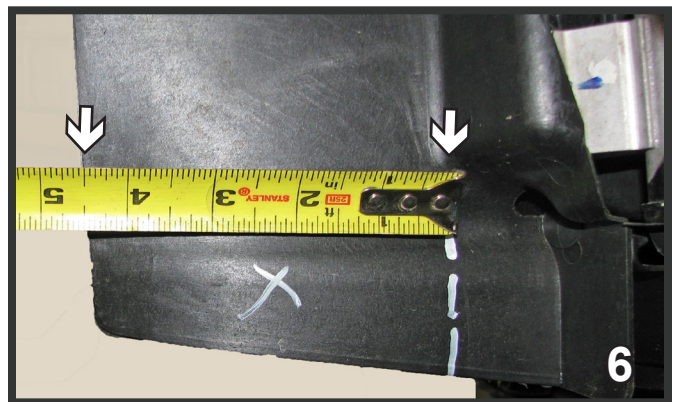
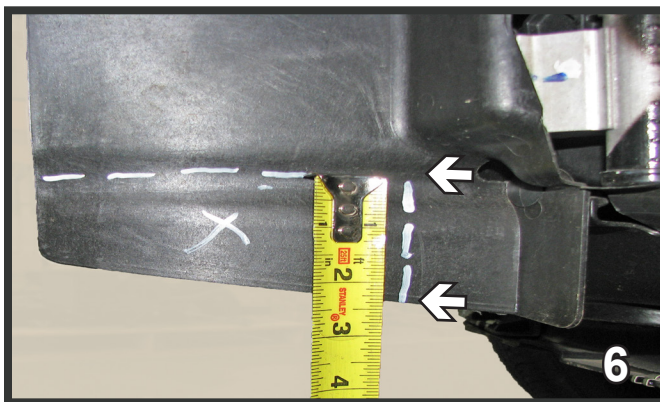

6. **MKT models:** On the passenger side, trim 2 1/4" up and 4 1/2" across.

BX2617  
2009-12 Lincoln MKS  
2010-12 Lincoln MKT  
Installation Instructions

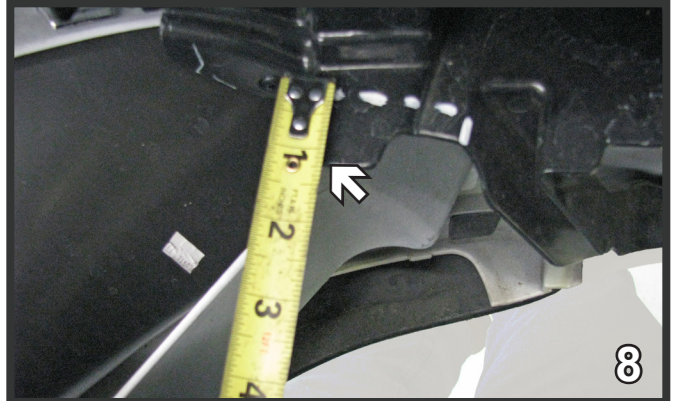
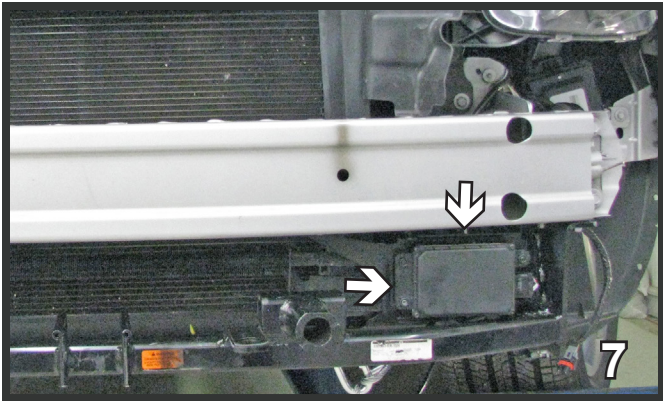

7. Remove the collision control module. Unsnap the module from the front side of the bracket by pulling the module forward. Unplug and set aside.
8. **MKS models:** On the back side of the fascia by the fog light, using a utility knife cut off the tab, 1" back and 2 1/4" wide. Do this on both sides.

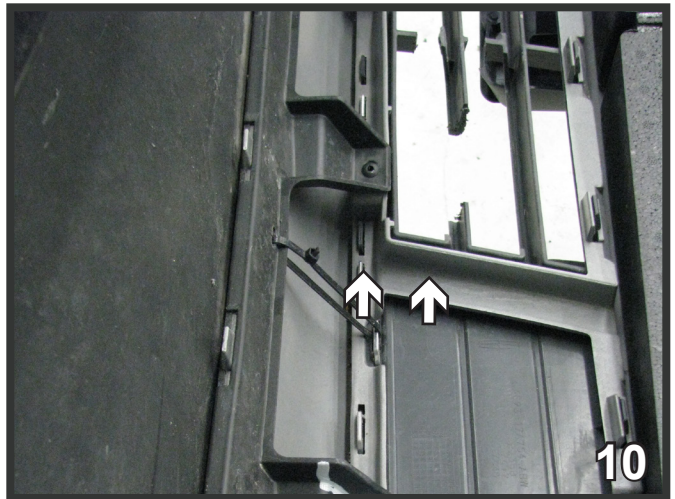

9. **MKS models:** On the back side of the fascia by the cruise control mechanism, using a utility knife, trim across the bottom, as shown. Do this to both sides of vehicle.
10. **MKT models:** Trim as shown on the back side of the fascia.

BX2617  
2009-12 Lincoln MKS  
2010-12 Lincoln MKT  
Installation Instructions

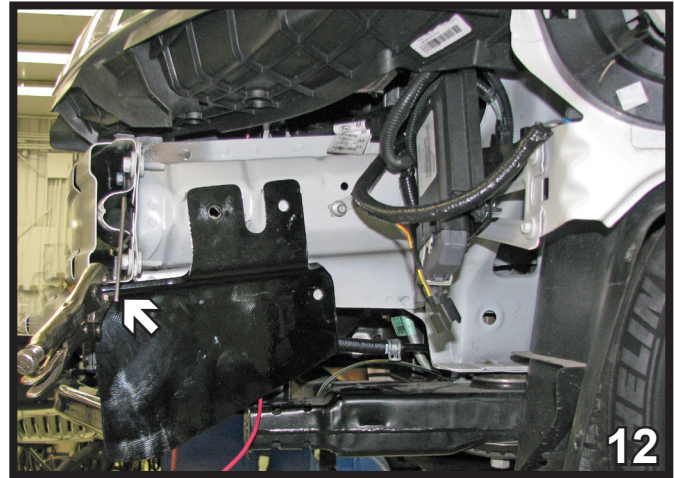
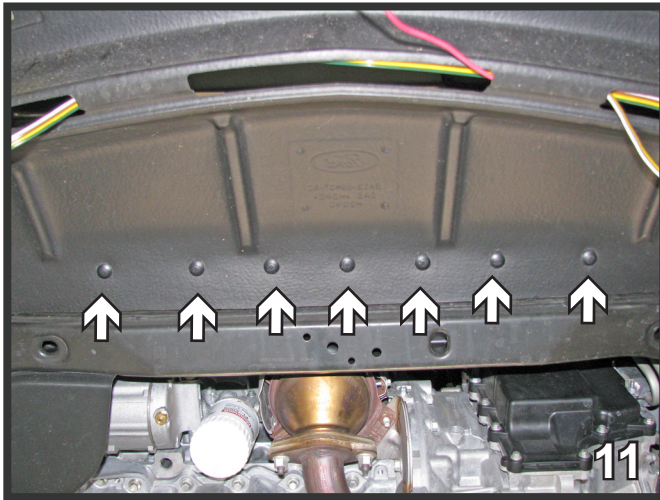

11. **MKS models:** Underneath the vehicle, using a flat screwdriver, remove seven push pins. Set the plastic cover and push pins aside to be reinstalled later.
12. Slide the base plate straight up from the bottom and clamp in front. Be sure the base plate is level with the frame, and up as far as possible. All the holes need to be drilled with a 13/32" drill bit.

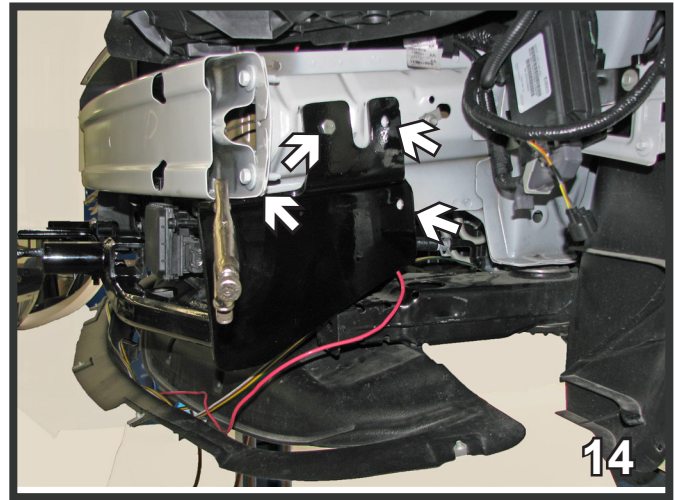
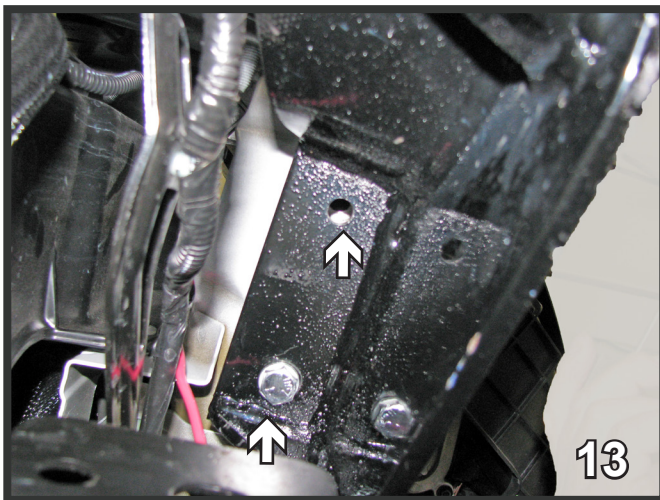

13. First using the baseplate as a template with a 13/32" drill bit, drill two holes underneath. Insert a 3/8"-16 x 2 1/2" bolt into the holes with 3/8" lock washers and 3/8"-16 nut plate, tighten with Loctite Red. Do the same on both sides of the vehicle.
14. Using the baseplate as a template with the 13/32" drill bit, drill a hole in the side and start a 3/8"-16 x 1 1/4" bolt with a 3/8" lock washer and a 3/8"-16 nut plate, inserted into the bumper opening. Continue with the three remaining holes. Do this to both sides.



BX2617  
2009-12 Lincoln MKS  
2010-12 Lincoln MKT  
Installation Instructions

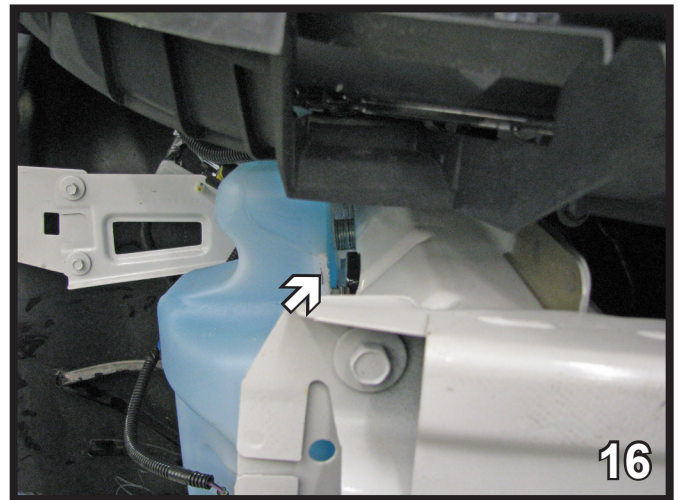
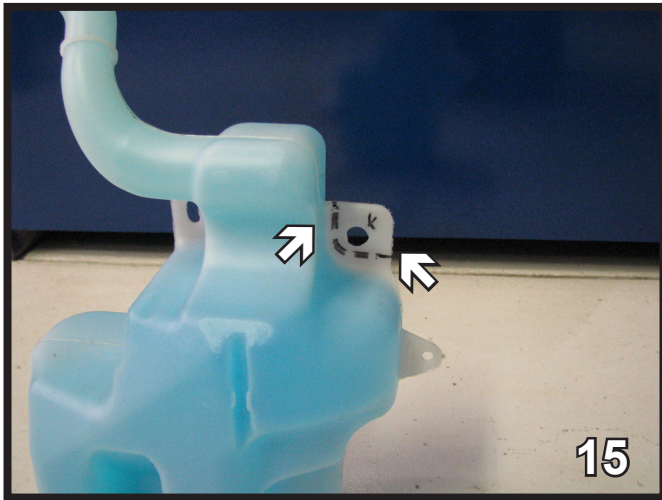

15. On the passenger side before reinstalling the washer reservoir, using a utility knife cut off the top right installation tab about 1 1/2" x 1 1/2". Be careful not to cut into reservoir. Reinstall the water tank and connect the hoses and plug in electrical connections.
16. Using the two existing studs on the left, reinstall the washer reservoir. Put seven 1/4" flat washers behind the washer on the top stud to offset away from the baseplate. Reconnect the hoses and plug in electrical connections.
17. Attach the permanent baseplate safety cables. Position the cables around a solid piece of the frame. 226-0049 base plate safety cables and 229-0512 quicklinks are recommended.
18. Reinstall horn, collision sensor and the plastic cover.



19. Hold the fascia up in front of the baseplate, mark and trim the area needed for the baseplate to come through. The installation of the baseplate is complete.

Install the tow bar and safety cables according to the instructions provided in their packages. When demonstrating this to the customer, be sure to include all the contents and packages.

Do **NOT** substitute other devices if the tow bar pins and clips are misplaced.

BX2617  
2009-12 Lincoln MKS  
2010-12 Lincoln MKT  
Installation Instructions

A large, light blue watermark of the Blue Ox logo is centered on the page. It features a stylized ox head profile within a circular frame, with the words "BLUE OX" written across the middle.

**CUSTOMER SERVICE COMMITMENT**

Blue Ox® is committed to providing you with exceptional customer care throughout your lifetime with our products. Our team is here to assist you with any questions you may have regarding the performance of your product. Simply call (402) 385-3051 and you can speak with our technical service team.

Additionally, please visit our website to see which rallies our Destination America team will be attending. For a nominal fee, our service technician will service your towing system to ensure it's in proper working condition. Also, as a commitment to our customers, should you visit our factory, you can stay at our full service Blue Ox® campground at no charge along with enjoying a factory tour.

Again, thank you for being our customer and for the confidence you have shown in the performance of our products. It is because of customers like you we enjoy the success we have today.

© 2016 Blue Ox  
One Mill Road, Industrial Park  
Pender, Nebraska 68047  
Phone: (402) 385-3051  
Fax: (402) 385-3360  
[www.blueox.com](http://www.blueox.com)

# General Information

1. Ensure that your product(s) are registered online at [www.blueox.com](http://www.blueox.com). It is crucial to register your product(s) so that you may be alerted of product offerings, updates, upgrades, maintenance and safety bulletins, and/or recalls.
2. **It is the owner's responsibility to inspect all towing equipment for cracked welds, missing or worn parts and loose bolts before each towing trip.** Be sure to use Loctite® Red on all bolts and tighten to the recommended specifications.
3. **It is the owner's responsibility to hook up all towing equipment per manufacturer's instructions/recommendations.**
4. Remove the attachment tabs when not in use (if applicable).

## Notice To Baseplate Installer

### 1. It is YOUR responsibility to watch for:

- Oil cooler and air conditioner lines
- Electrical wires and hoses
- Missing parts or attaching points on the frame

\*\* If the baseplate is improperly installed and is against a wire or hose, it could cause fluid leaks or electrical shorts some time after the actual baseplate installation.

## Permanent Baseplate Safety Cable Installation

Permanent baseplate safety cables are strongly recommended when towing a vehicle with a tow bar. The principle function of the permanent baseplate safety cables is to prevent the towed vehicle from breaking loose in the event the connection between the frame of the towed vehicle and the baseplate fails or becomes disconnected. The cables must be connected from the baseplate to the frame rail or cross member of the vehicle's frame. The illustrations below show the possible arrangements recommended by Blue Ox®. Each permanent baseplate safety cable must have an adequate weight rating for the towing system. The weight rating of the two (2) cables together will not qualify.

***Do not mount the permanent baseplate safety cables against wires, hoses or brake lines.***

These permanent baseplate safety cables should remain installed as long as the baseplate is installed on the vehicle. Permanent baseplate safety cables are to be used in conjunction with, and NOT a replacement for legally required safety cables attaching the towed vehicle to the towing vehicle.

### Option #1

(Baseplates with Convenience Link Tabs)

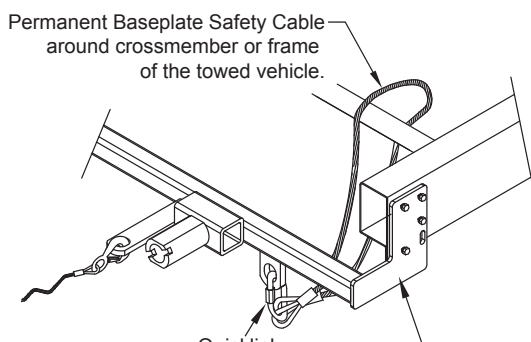

### Option #2

(Baseplates with out Convenience Link Tabs)

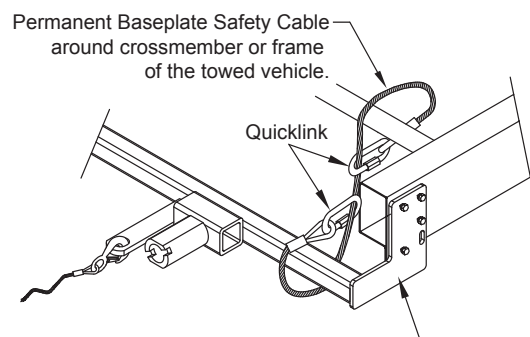

# BLUE OX ORIGINAL PURCHASERS THREE YEAR LIMITED WARRANTY

Automatic Equipment Manufacturing Company ("Automatic") warrants to the original (first) retail purchaser that this product, manufactured by Automatic, shall be free from defect in material and workmanship under normal use and service for a period of three years from the date of delivery.

During said three-year period, Automatic will repair or replace any parts that have been returned by the original purchaser, to the factory, transportation prepaid, and in Automatic's sole and absolute opinion found to be defective.

Limitations on Warranty Coverage:

Coverage under this warranty will be valid only if the customer warranty card is returned by the original purchaser within 30 days of purchase.

Coverage under this warranty will be effective only when a copy of the original invoice, showing date and place of purchase, accompanies any claim for warranty. This warranty is NON TRANSFERABLE.

This limited warranty will not cover, in any way or form, any alleged damages caused by incorrect or improper installation, improper use, modification or neglect of product, failure to properly service and maintain, misuse, act of God, accident or failure of the user to follow guidelines contained in the instructional material provided by Automatic.

This warranty does not cover normal wear and tear, paint or rust.

Warrantor assumes no responsibility to the owner for loss of use of product, loss of time, inconvenience or any other damage consequential or otherwise. Including, but not limited to mileage, expense of transporting of product, return shipping expense, mechanics travel time, telephone, road service, towing, and rental during repairs, travel, lodging, loss or damage to personal property or loss of earnings.

**REPAIR OR REPLACEMENT AS SET FORTH IN THIS LIMITED WARRANTY IS THE SOLE EXCLUSIVE REMEDY OF THE PURCHASER. AUTOMATIC SHALL NOT BE LIABLE FOR ANY INCIDENTAL OR CONSEQUENTIAL DAMAGES FOR BREACH OF ANY EXPRESS OR IMPLIED WARRANTY ON THIS PRODUCT. EXCEPT TO THE EXTENT PROHIBITED BY APPLICABLE LAW, ANY IMPLIED WARRANTY OF MERCHANTABILITY OR FITNESS FOR A PARTICULAR PURPOSE ON THIS PRODUCT IS LIMITED IN LENGTH TO THE DURATION OF THIS WARRANTY.**

Please visit <http://blueox.com/warranty/> to register your warranty

