



## BX2607

# 2008-2010 Mercury Sable 2008-2009 Ford Taurus Installation Instructions

**Attachment Tab Height: 13-1/2"**

**Attachment Tab Width: 22"**

**Serial Number**

**Please read BOTH these Installation Instructions and the General Information sheet prior to installing or operating this equipment.**

1. Blue Ox® towing products and accessories are intended to be installed by Blue Ox® Dealers who are familiar with our products and have the equipment and knowledge necessary to do "fit work". If needed, Blue Ox® Dealers can be found at [www.blueox.com](http://www.blueox.com) or by contacting our Technical Service Department at (402) 385-3051.
2. Many Blue Ox® baseplates are designed to use existing holes and hardware to mount the baseplate to the towed vehicle. Even though bolts are there, do not assume they are adequate for baseplate mounting. Always use the hardware supplied in the hardware kit and existing hardware as specified in the installation instructions.



If the front of your vehicle looks different than this, please contact us at (402)385-3051.

**Reference your vehicle owner's manual for manufacturer's towing specifications.**

### Bolt Torque Specifications

Torque in Foot-Pounds for Inch Bolts

Bolt Size	Grade 5	Grade 8
1/4"	10	14
5/16"	19	29
3/8"	33	47
7/16"	54	78
1/2"	78	119
5/8"	154	230
3/4"	257	380

### Bolt Torque Specifications

Torque in Foot-Pounds for Metric Bolts

Bolt Size	Grade 8.8	Grade 10.9
6MM	6	8
8MM	16	22
10MM	31	40
12MM	54	70
14MM	89	117
16MM	161	230
18MM	222	318



## WARNING

Failure to read and follow these instructions could result in separation of the towed vehicle from the tow bar, causing property damage, loss of towed vehicle, personal injury or death.

BX2607  
2008-2010 Mercury Sable  
2008-2009 Ford Taurus  
Installation Instructions

**Tools Required**  
 Loctite® RED  
 8mm Socket  
 10mm Socket  
 9/16" Socket  
 Phillips Screwdriver  
 1-1/4" Hole Saw  
 13/32" Drill Bit  
 Hack Sawblade

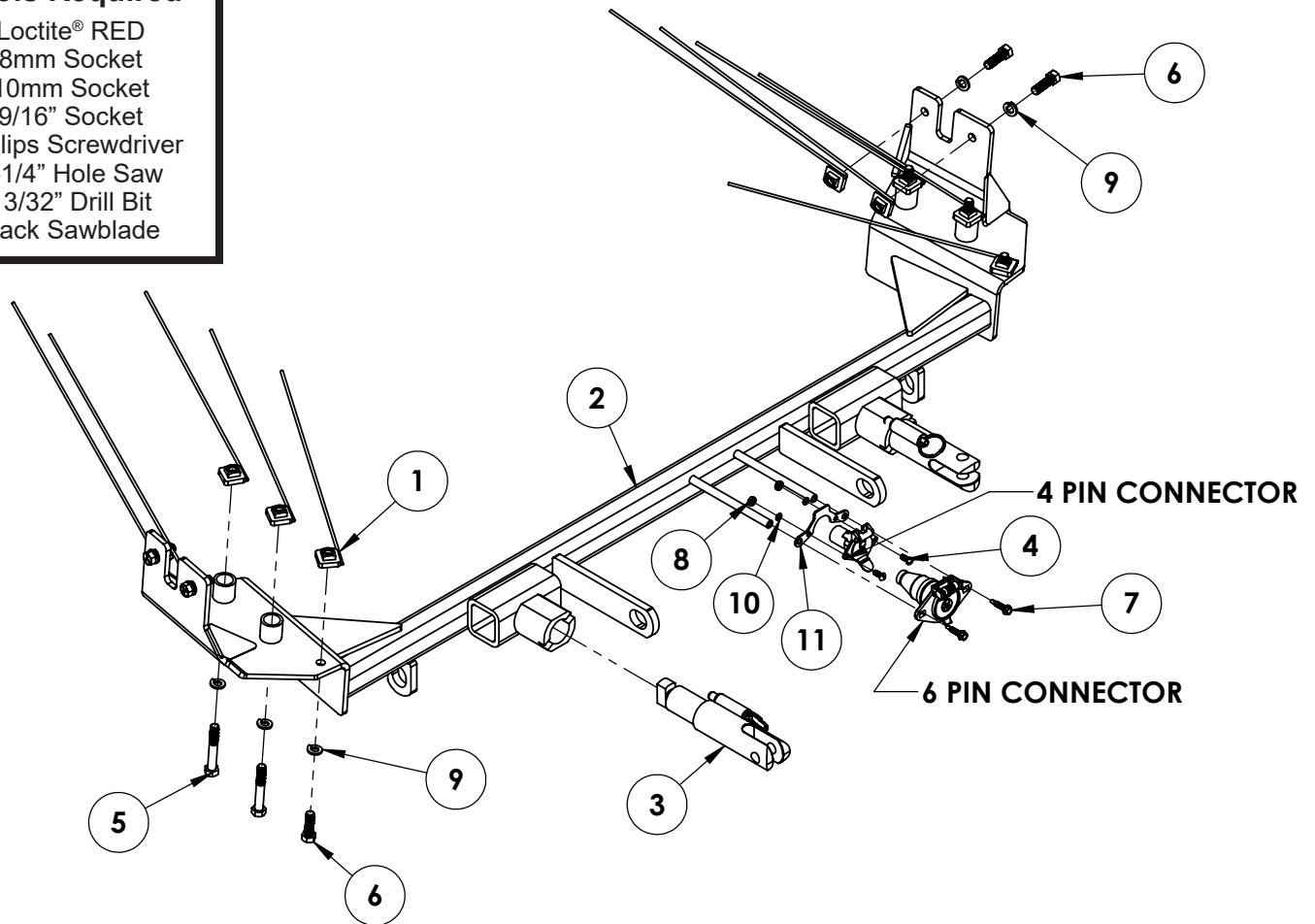

Item No.	Part No.	Description	Qty.
1.....	61-5208.....	3/8"-16 Nut Plate w/ 14" Wire.....	10
2.....	61-6623.....	BX2607 Baseplate.....	1
3.....	62-3468.....	Attachment Tab Assembly with Hole.....	2
4.....	201-0192.....	#10-32 1/2" Round Slotted Head Screw.....	2
5.....	201-0336.....	3/8"-16 x 1-1/4" Hex Head Bolt Grade 5, ZP.....	4
6.....	201-0368.....	3/8"-16 x 1-1/4" Hex Head Bolt, Grade 5, ZP.....	6
7.....	201-0979.....	#12-14 x 1" Self Drilling Screw, ZP.....	2
8.....	202-0047.....	#10-32 Hex Nut.....	2
9.....	203-0010.....	3/8" Lock Washer, ZP.....	10
10.....	203-0054.....	#10 Lock Washer, ZP.....	2
11.....	299-0685.....	Electrical Bracket.....	1
12.....	226-0046(not shown).....	Class III Safety Cables.....	2
13.....	229-0359(not shown).....	3/8" Quicklink, ZP.....	2
14.....	290-0437(not shown).....	Black Cap Plug Receiver.....	2

**Important:**

Use only genuine factory replacement parts on your baseplate. Do **NOT** substitute homemade or non-typical parts. If a bolt is lost or in need of replacement, for your safety and the preservation of your baseplate, be sure to use a replacement bolt of the same grade (In most cases it will be Grade 5, please reference the parts list above). Replacement parts may be ordered through your nearest Blue Ox® Dealer or Distributor. Failing to follow and/or altering these installation instructions in either installation or required equipment will void the manufacturer's warranty. Towing behind a non-motorized vehicle will void the warranty.

BX2607  
2008-2010 Mercury Sable  
2008-2009 Ford Taurus  
Installation Instructions

**Vehicle Weight:** Motorhome mount tow bars are recommended for use with this baseplate. Due to the design of the removable tabs, the RangeFinderII, Adventurer, and Ambassador tow bars can not be used. The Acclaim tow bar may be used, but will not fold and store on the front of the vehicle. Adapters, except the BX8833 and BX88151, can not be used with this baseplate.

**Installation Notes:** The fascia, guard, washer reservoir, bolts, push pins and screws are removed for installation. Drilling is required. Trimming is required.

The dimensional variations between otherwise identical vehicles can be considerable. While the baseplate was designed for easy installation, it may be necessary to tailor the baseplate slightly to compensate for auto manufacturer's tolerances. These minor adjustments may include filing a hole slightly, bending electrical rods or bending end plates.

The BX8848 4-Diode Wiring Kit is recommended for this vehicle.

**Handling of some cosmetic parts when installing this product may require the use of protective covers, rags, specialty tools, etc. to prevent damage.**

**Do not use the towed vehicle for storing luggage, equipment, etc. This may cause you to exceed the towing capacity of the tow bar, baseplate, and its accessories.**

## Installation Instructions:

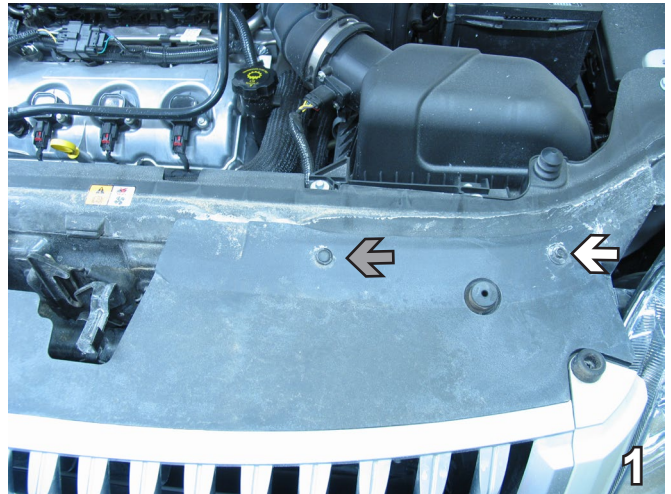

1. Using a 8MM socket, remove a metric bolt from the corner of the plastic on top of the fascia. Also using a flat screwdriver, remove the push pin (grey arrow). Do this to both sides of the vehicle. Set bolts and push pins aside to be reinstalled later.



2. Using a Phillips screwdriver, remove three (3) screws, located just forward of the front tire. Do this to both sides of the vehicle. Set screws aside to be reinstalled later.



BX2607  
2008-2010 Mercury Sable  
2008-2009 Ford Taurus  
Installation Instructions

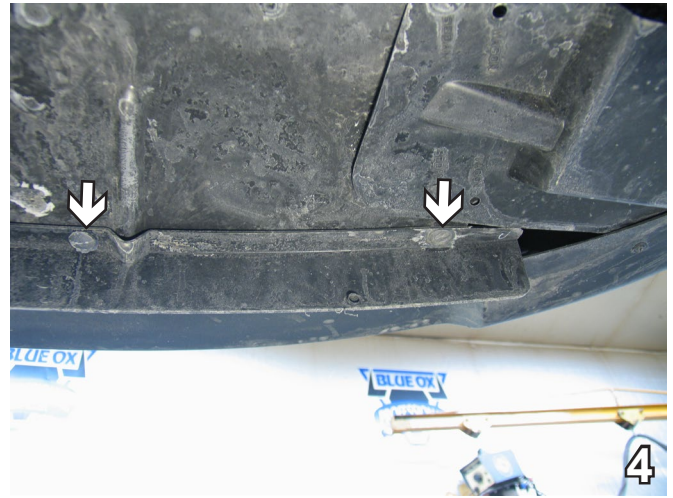

3. Using a Phillips screwdriver, remove two (2) screws, located in front underneath on the driver's side. On the passenger side, remove the two (2) screws and using an 8MM socket, remove one bolt. Set screws and bolt aside to be reinstalled later.
4. Still underneath, remove the four (4) push pins, two (2) on each side, holding the plastic guard. Set guard and push pins aside to be reinstalled later.

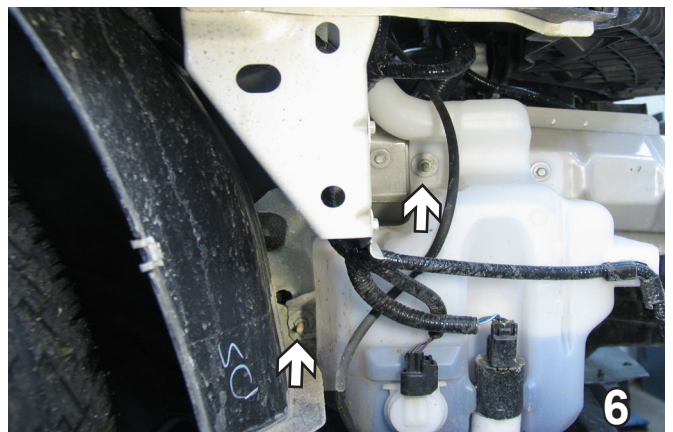

5. In front right under the opening, using an 8MM socket, remove the three (3) bolts. Pull fascia corners out to the side of vehicle, then pull forward. Set fascia and bolts aside carefully, to be reinstalled later.
6. On the passenger side in order to remove the washer reservoir, remove the two (2) bolts from the left side using an 11MM socket. Set bolts aside to be reinstalled later.

7. Continuing with the washer reservoir, use an 8MM socket to remove the top right metric bolt which will not be reinstalled. Unplug everything and completely remove. Then using a hack saw blade trim the tab off. Set the washer reservoir aside to be reinstalled.

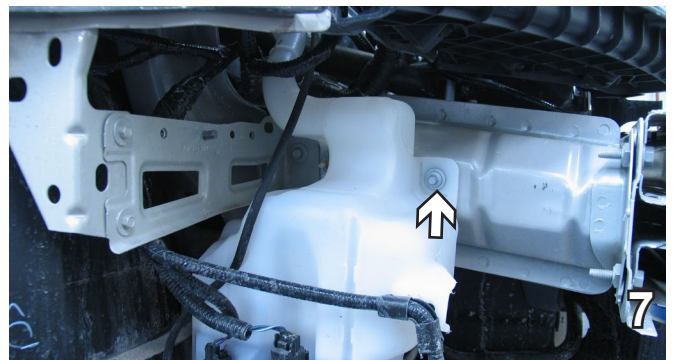

BX2607  
2008-2010 Mercury Sable  
2008-2009 Ford Taurus  
Installation Instructions

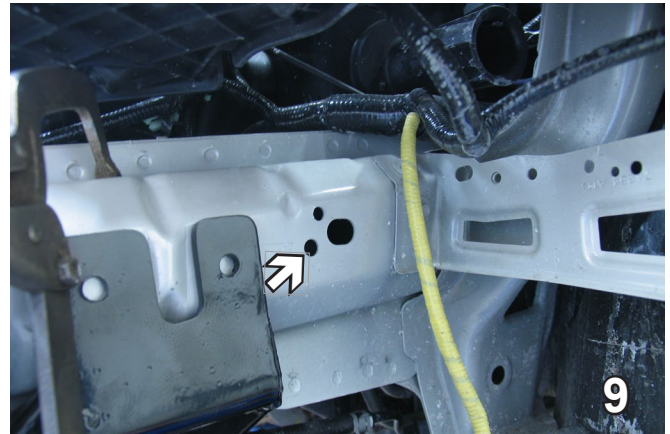
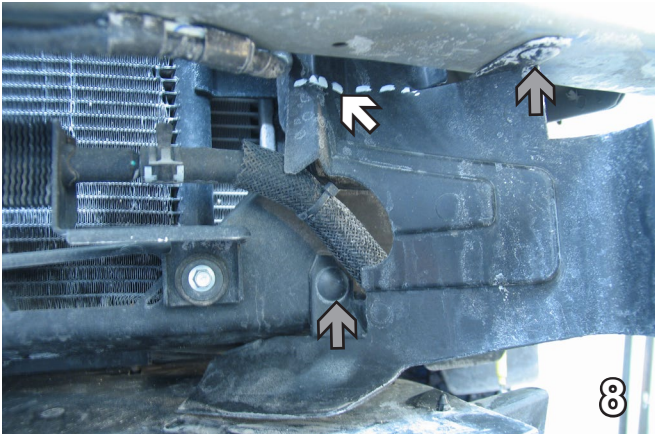

8. Under the bumper, using a hack saw blade, cut the piece of plastic as shown. Using the Phillips screwdriver, remove the two (2) push pins (gray arrows). Do this on both sides. Remove the lower plastic and discard pieces and pins, they will not be reused.
9. Using a 1-1/4" hole saw, drill a hole in the bottom round hole. Do this to both sides of vehicle.



10. Slide the base plate straight up from the bottom and clamp.
11. Be sure the base plate is level across the top with respect to the vehicle frame, and up as far as possible. All the holes need to be drilled with a 13/32" drill bit. First drill a hole across the side and start a 3/8"-16 x 1-1/4" bolt with a 3/8" lock washer and a 3/8"-16 nut plate, inserted into 1 1/4" drilled hole. Continue with the second hole. Do this to both sides. Tighten with Loctite Red.

**BE SURE TO USE LOCTITE® RED ON ALL BOLTS BEFORE TIGHTENING. TIGHTEN ALL BOLTS ACCORDING TO THE TORQUE CHART ON THE FRONT PAGE OF THESE INSTRUCTIONS OR ON PAGE 3 OF THE BASEPLATE TOWING GENERAL INSTRUCTIONS.**

**When using power drills be aware of the dangers of torque and drill bit length.**



BX2607  
2008-2010 Mercury Sable  
2008-2009 Ford Taurus  
Installation Instructions

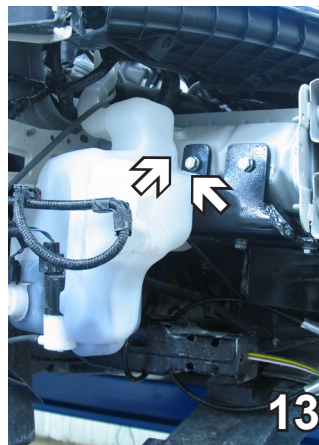
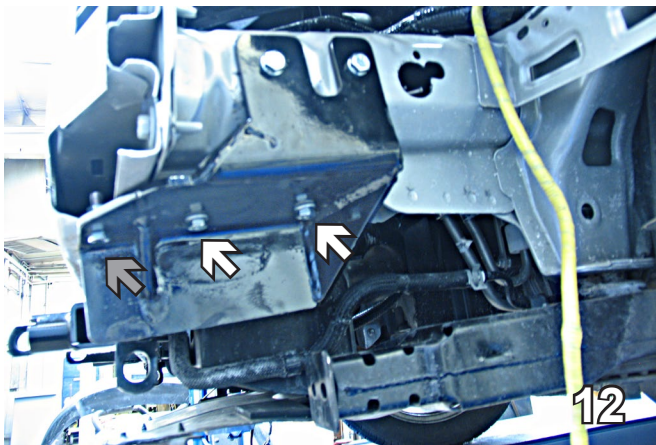

12. Moving underneath the base plate, drill three (3) remaining holes using a 13/32" drill bit. Insert a 3/8"-16 x 1-1/4" bolt into the front hole (grey arrow). Use 3/8"-16 x 2-1/2" bolts for the other two (2) holes. They all need 3/8" lock washers and 3/8"-16 nut plate, tighten with Loctite Red. Do the same on both sides of the vehicle. NOTE: Due to the compact space underneath the baseplate, drilling at an angle may be required.
13. On the passenger side before reinstalling the washer reservoir, using a hack saw blade cut off the top right installation tab about 1-1/2" x 1-1/2". Be careful not to cut into reservoir. Reinstall the water tank and connect the hoses and plug in electrical connections.

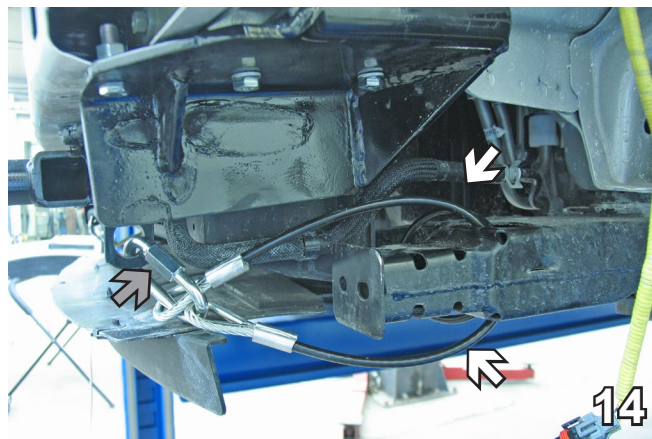

14. Attach the permanent baseplate safety cables to the provided convenience link on the baseplate (gray arrow). The photo above shows the recommended installation of the cables to frame of vehicle (white arrows). Additional options may interfere with suggested mounting; in this case secure the cables to a solid piece of the frame as described in the instructions included with the permanent baseplate safety cables. Be sure the safety cables do not rub against any hoses or moving parts. Do this to both sides.
15. Reinstall fascia, guard, bolts, push pins and screws. The installation of the baseplate is complete.

Install the tow bar and safety cables according to the instructions provided in their packages. When demonstrating this to the customer, be sure to include all the contents and packages.

Do **NOT** substitute other devices if the tow bar pins and clips are misplaced.

**Be sure that ALL electrical connections are plugged in properly and functioning BEFORE installing the fascia.**

**DEALER or INSTALLER:**  
**Be certain the user receives the instruction sheets for their products.**

BX2607  
2008-2010 Mercury Sable  
2008-2009 Ford Taurus  
Installation Instructions



Shown without removable tabs installed.



Shown with removable tabs installed.

**If the baseplate is in an accident, it must be replaced. DO NOT use it again! An accident can cause unseen damage and using it again could result in more damage or serious injury. DO NOT use the baseplate if it is damaged or missing parts.**

## CUSTOMER SERVICE COMMITMENT

Blue Ox® is committed to providing you with exceptional customer care throughout your lifetime with our products. Our team is here to assist you with any questions you may have regarding the performance of your product. Simply call (402) 385-3051 and you can speak with our customer care team.

Additionally, please visit our website to see which rallies our Destination America team will be attending. For a nominal fee, our service technician will service your towing system to ensure it's in proper working condition. Also, as a commitment to our customers, should you visit our factory, you can stay at our full service Blue Ox® campground at no charge along with enjoying a factory tour.

Again, thank you for being our customer and for the confidence you have shown in the performance of our products. It is because of customers like you we enjoy the success we have today.

© 2013 Blue Ox  
One Mill Road, Industrial Park  
Pender, Nebraska 68047  
Phone: (402) 385-3051  
Fax: (402) 385-3360  
[www.blueox.com](http://www.blueox.com)

# General Information

1. Ensure that your product(s) are registered online at [www.blueox.com](http://www.blueox.com). It is crucial to register your product(s) so that you may be alerted of product offerings, updates, upgrades, maintenance and safety bulletins, and/or recalls.
2. **It is the owner's responsibility to inspect all towing equipment for cracked welds, missing or worn parts and loose bolts before each towing trip.** Be sure to use Loctite® Red on all bolts and tighten to the recommended specifications.
3. **It is the owner's responsibility to hook up all towing equipment per manufacturer's instructions/recommendations.**
4. Remove the attachment tabs when not in use (if applicable).

## Notice To Baseplate Installer

### 1. It is YOUR responsibility to watch for:

- Oil cooler and air conditioner lines
- Electrical wires and hoses
- Missing parts or attaching points on the frame

\*\* If the baseplate is improperly installed and is against a wire or hose, it could cause fluid leaks or electrical shorts some time after the actual baseplate installation.

## Permanent Baseplate Safety Cable Installation

Permanent baseplate safety cables are strongly recommended when towing a vehicle with a tow bar. The principle function of the permanent baseplate safety cables is to prevent the towed vehicle from breaking loose in the event the connection between the frame of the towed vehicle and the baseplate fails or becomes disconnected. The cables must be connected from the baseplate to the frame rail or cross member of the vehicle's frame. The illustrations below show the possible arrangements recommended by Blue Ox®. Each permanent baseplate safety cable must have an adequate weight rating for the towing system. The weight rating of the two (2) cables together will not qualify.

***Do not mount the permanent baseplate safety cables against wires, hoses or brake lines.***

These permanent baseplate safety cables should remain installed as long as the baseplate is installed on the vehicle. Permanent baseplate safety cables are to be used in conjunction with, and NOT a replacement for legally required safety cables attaching the towed vehicle to the towing vehicle.

### Option #1

(Baseplates with Convenience Link Tabs)



### Option #2

(Baseplates with out Convenience Link Tabs)





# BLUE OX ORIGINAL PURCHASERS THREE YEAR LIMITED WARRANTY

Automatic Equipment Manufacturing Company ("Automatic") warrants to the original (first) retail purchaser that this product, manufactured by Automatic, shall be free from defect in material and workmanship under normal use and service for a period of three years from the date of delivery.

During said three-year period, Automatic will repair or replace any parts that have been returned by the original purchaser, to the factory, transportation prepaid, and in Automatic's sole and absolute opinion found to be defective.

Limitations on Warranty Coverage:

Coverage under this warranty will be valid only if the customer warranty card is returned by the original purchaser within 30 days of purchase.

Coverage under this warranty will be effective only when a copy of the original invoice, showing date and place of purchase, accompanies any claim for warranty. This warranty is NON TRANSFERABLE.

This limited warranty will not cover, in any way or form, any alleged damages caused by incorrect or improper installation, improper use, modification or neglect of product, failure to properly service and maintain, misuse, act of God, accident or failure of the user to follow guidelines contained in the instructional material provided by Automatic.

This warranty does not cover normal wear and tear, paint or rust.

Warrantor assumes no responsibility to the owner for loss of use of product, loss of time, inconvenience or any other damage consequential or otherwise. Including, but not limited to mileage, expense of transporting of product, return shipping expense, mechanics travel time, telephone, road service, towing, and rental during repairs, travel, lodging, loss or damage to personal property or loss of earnings.

**REPAIR OR REPLACEMENT AS SET FORTH IN THIS LIMITED WARRANTY IS THE SOLE EXCLUSIVE REMEDY OF THE PURCHASER. AUTOMATIC SHALL NOT BE LIABLE FOR ANY INCIDENTAL OR CONSEQUENTIAL DAMAGES FOR BREACH OF ANY EXPRESS OR IMPLIED WARRANTY ON THIS PRODUCT. EXCEPT TO THE EXTENT PROHIBITED BY APPLICABLE LAW, ANY IMPLIED WARRANTY OF MERCHANTABILITY OR FITNESS FOR A PARTICULAR PURPOSE ON THIS PRODUCT IS LIMITED IN LENGTH TO THE DURATION OF THIS WARRANTY.**

Please visit <http://blueox.com/warranty/> to register your warranty

