



**BLUE OX**<sup>®</sup>

Baseplate Installation Instructions

BX2602

2008-10 Ford F250 SD (2WD/  
4WD) Diesel

2008-09 F450 (2WD/4WD)

Installation Instructions

Serial Number

Please read BOTH these Installation Instructions and the General Towing Instructions before attempting to install or operate this equipment.

1. Blue Ox<sup>®</sup> towing products and accessories are intended to be installed by Blue Ox<sup>®</sup> Dealers who are familiar with our products and have the equipment and knowledge to do “fit work.” When necessary, Blue Ox<sup>®</sup> Dealers can be found at [www.blueox.us](http://www.blueox.us) or by contacting our Customer Care Department at (888) 425-5382.

Attachment Tab Height: 23 1/2”

Attachment Tab Width: 34 1/2”

2. Many Blue Ox<sup>®</sup> Baseplates are designed to use existing holes and hardware to mount the baseplate to the towed vehicle. Even though bolts are there, do not assume they are adequate for baseplate mounting. Always use hardware supplied in the hardware kit or existing hardware specified in the Baseplate Towing Installation Instructions.

**Bolt Torque Specifications**

Torque in Foot-Pounds for Metric Bolts

Bolt Size	Grade 8.8	Grade 10.9
6MM	6	8
8MM	16	22
10MM	31	40
12MM	54	70
14MM	89	117

Confirm the towability and pre-towing procedures for your vehicle with the owner’s manual or contact the vehicle’s manufacturer for specific towing procedures.

**Bolt Torque Specifications**

Torque in Foot-Pounds for Inch Bolts

Bolt Size	Grade 5	Grade 8
1/4”	10	14
5/16”	19	29
3/8”	33	47
7/16”	54	78
1/2”	78	119
5/8”	154	230

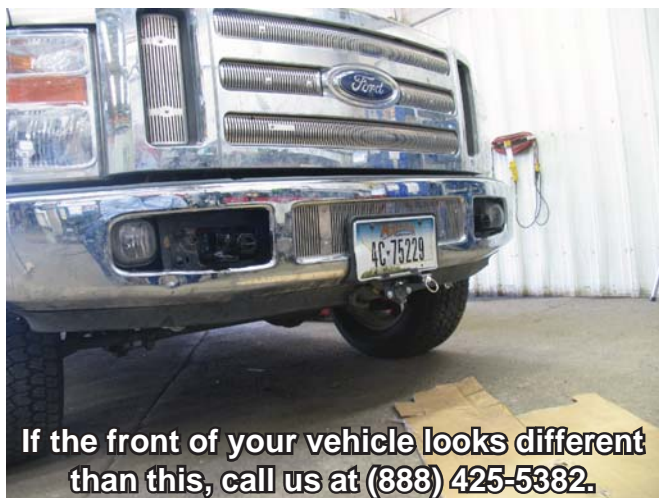

If the front of your vehicle looks different than this, call us at (888) 425-5382.



**WARNING**

Failure to read and follow these instructions could result in separation of the towed vehicle from the tow bar, causing property damage, loss of towed vehicle, personal injury or death.

# BX2602 2008-10 Ford F250 SD (2WD/ 4WD) Diesel 2008-09 F450 (2WD/4WD)

## Installation Instructions

### Parts List

Ref. No.	Qty.	Part #	Description
1	1	61-6511	WLDM'T, BASEPLATE, DS, BX2602
2	1	61-6512	WLDM'T, BASEPLATE, PS, BX2602
3	1	101-6135	BRACKET ELECTRICAL, 90 DEGR.
4	12	201-0051	1/2-13 X 1 1/2 HEX BOLT GRD.5, ZP
5	12	203-0012	1/2 LOCK WASHER, ZP
6	12	202-0005	1/2-13 HEX NUT, ZP
7	4	201-0050	1/4-20 X 3/4 HEX BOLT GRD.5, ZP
8	4	203-0008	1/4 LOCK WASHER, ZP
9	4	203-0001	1/4 FLAT WASHER, ZP
10	4	202-0069	1/4-20 HEX FLANGE WHIZ LOCK NUT, ZP
11	2	201-0192	10-32 X 1/2 SLOT, RD. HD. SCREW
12	2	203-0054	#10 LOCK WASHER
13	2	202-0047	#10-32 HEX NUT
14	2	101-5822	ADAPTER, 4 WAY CONNECTOR
15	2	62-3469	ATT TAB ASSY, REM, SF/LB, 1 HOLE
	2	226-0049	BASEPLATE SAFETY CABLE, 36" CL IV (Not Shown)
	2	229-0512	QUICKLINK, 1/2, ZP (Not Shown)
	2	290-0437	RECEIVER, CAP PLUG (BLK) (Not Shown)

### Tools Required

Loctite® RED  
3/4" Socket  
15MM Socket  
18MM Socket  
17/32" Drill Bit

The BX8869 Bulb and Socket Wiring Kit is recommended for this vehicle.

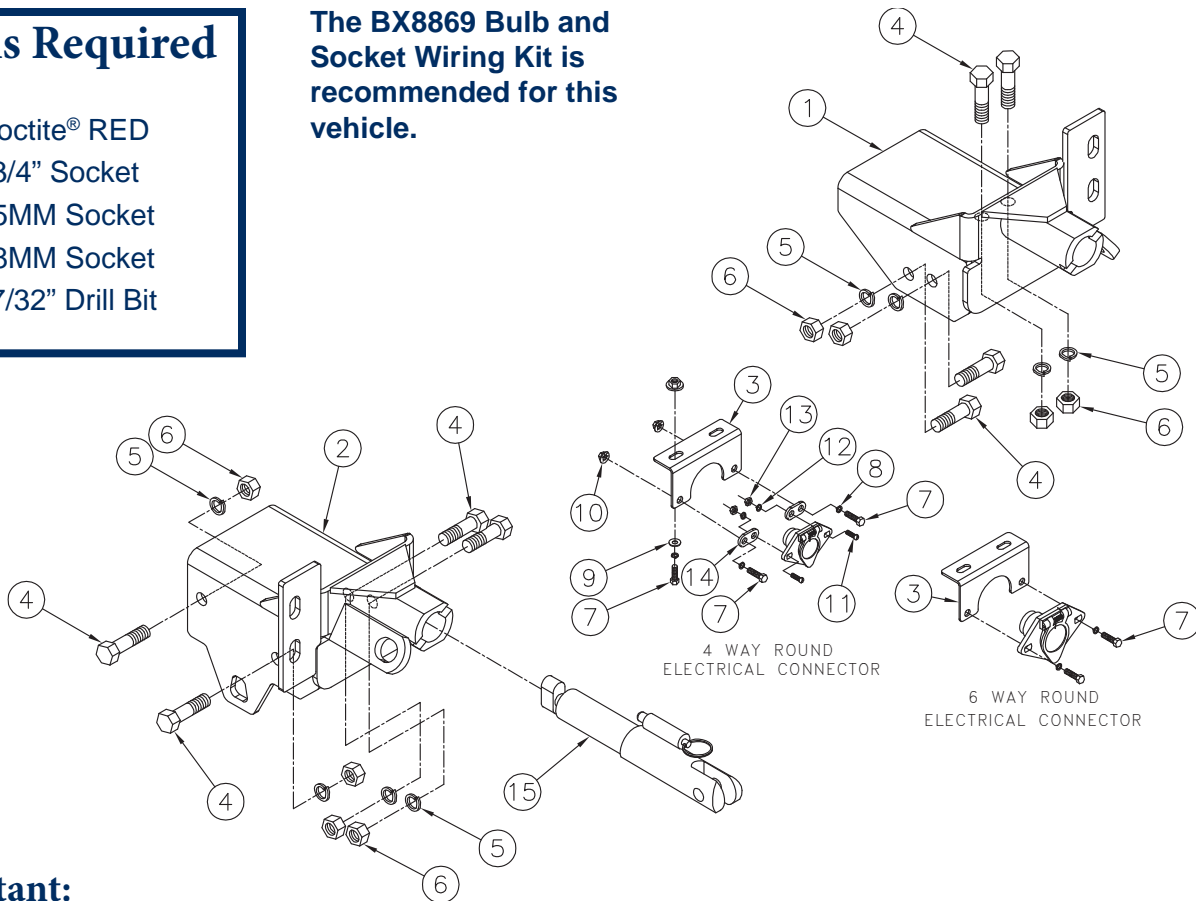

### Important:

Use only genuine factory replacement parts on your baseplate. Do **NOT** substitute homemade or non-typical parts. If a bolt is lost or in need of replacement, for your safety and the preservation of your baseplate, be sure to use a replacement bolt of the same grade (In most cases it will be Grade 5, please reference the parts list above). Replacement parts may be ordered through your nearest Blue Ox® Dealer or Distributor. Failing to follow and/or altering these installation instructions in either installation or required equipment will void the manufacturer's warranty.

BX2602  
2008-10 Ford F250 SD (2WD/ 4WD) Diesel  
2008-09 F450 (2WD/4WD)

Installation Instructions

**Vehicle Weight:**

The weight of this vehicle is near the Class III, 5,000 lbs. rating limitations. Some models, depending on options, may well exceed this 5,000 lb rating. Be sure to confirm the weight of your individual vehicle before towing. As of 1999 the Aventa® II is now rated 10,000 lbs. and either the Aventa® II or the Aventa® LX tow bar must be used for these applications.

**Tow Bar Adapters are NOT to be used with vehicles weighing over 5,000 lbs.**

**Installation Notes:** The fascia and air dam are removed for installation.

The dimensional variations between otherwise identical vehicles can be considerable. While the baseplate was designed for easy installation, it may be necessary to tailor the baseplate slightly to compensate for auto manufacturer's tolerances. These minor adjustments may include filing a hole slightly, bending electrical rods or bending end plates.

The BX8869 Bulb and Socket Wiring Kit is recommended for this vehicle.

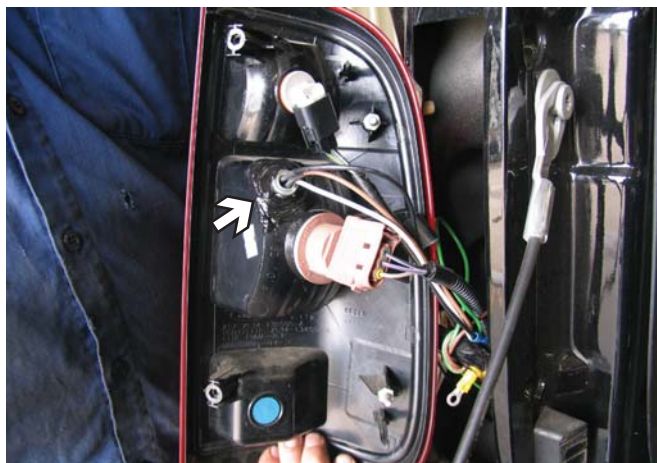

**Possible Location for the BX8869  
Bulb and Socket Wiring Kit.**

**Installation Instructions:**



1. Using a 18MM socket, remove two metric bolts from the bumper, located just beside the fog light assembly. Do this to both sides of the vehicle. Set bolts aside to be reinstalled later.



2. Just behind the metal bumper on the frame down by the headlight, there is a bolt that needs to be removed. Use a 15MM socket. Do this to both sides. Set bolts aside to be reinstalled later.

BX2602  
 2008-10 Ford F250 SD (2WD/ 4WD) Diesel  
 2008-09 F450 (2WD/4WD)

Installation Instructions

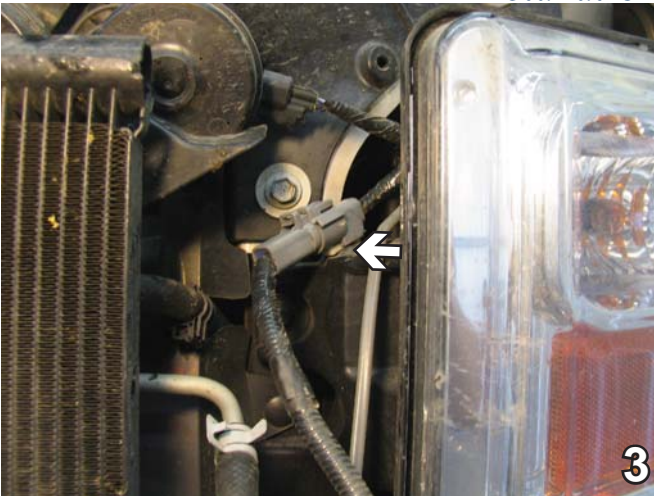

3. By the headlight, unplug the connector that disconnects everything that goes with the bumper. Pull the bumper forward and set aside to be reinstalled later.



4. Remove the tow hook from both sides by removing the three bolts using an 18MM socket. Set tow hooks and bolts aside--they will not be used again.

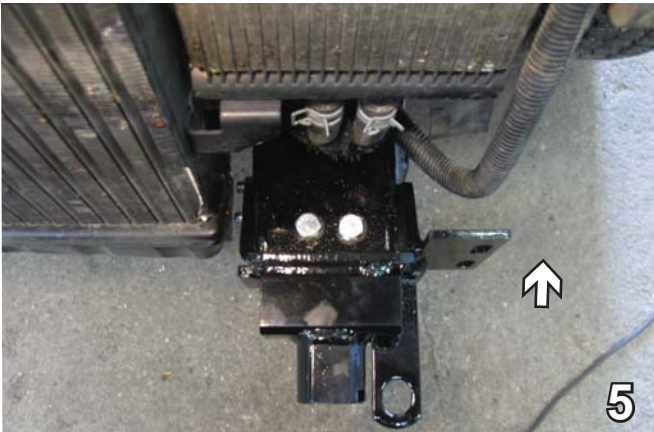

5. Slide baseplate on, align with existing two tow hook holes on the top.

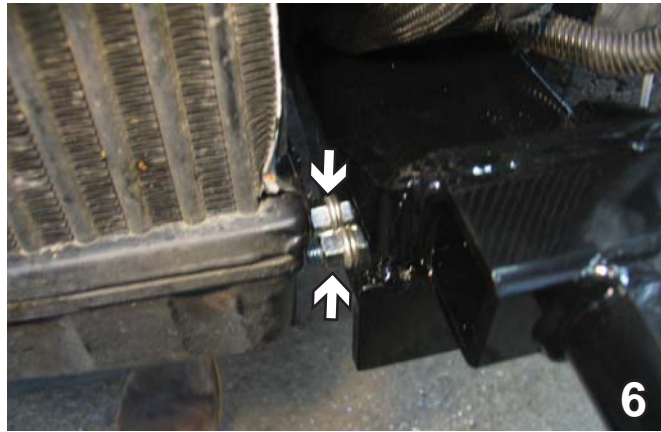

6. First insert 1/2-13 x 1 1/2" hex bolts with 1/2" lock washers and 1/2-13 hex nuts on the left side. Tighten with Loctite Red. On the driver's side, the nuts are facing out.

7. Insert 1/2-13 x 1 1/2" hex bolt with 1/2" lock washer and 1/2-13 hex nut in existing hole. Then the top two. With the baseplate as a template, use a 17/32" drill bit to drill the back hole on the right side (grey arrow). Insert bolt, washer and nut. Tighten with Loctite Red.

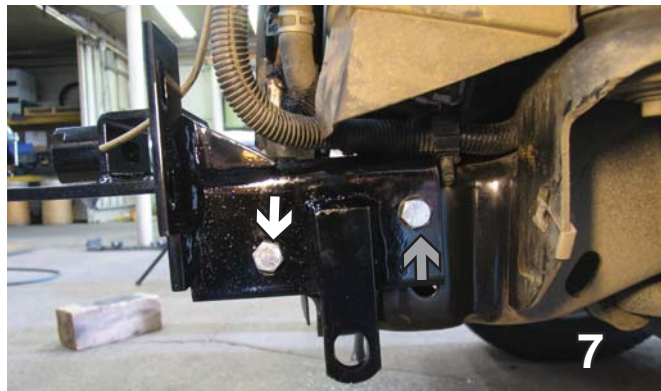

**BE SURE TO USE LOCTITE® RED ON ALL BOLTS BEFORE TIGHTENING. TIGHTEN ALL BOLTS ACCORDING TO THE TORQUE CHART ON THE FRONT PAGE OF THESE INSTRUCTIONS OR ON PAGE 3 OF THE BASEPLATE TOWING GENERAL INSTRUCTIONS.**

BX2602  
2008-10 Ford F250 SD (2WD/ 4WD) Diesel  
2008-09 F450 (2WD/4WD)  
Installation Instructions

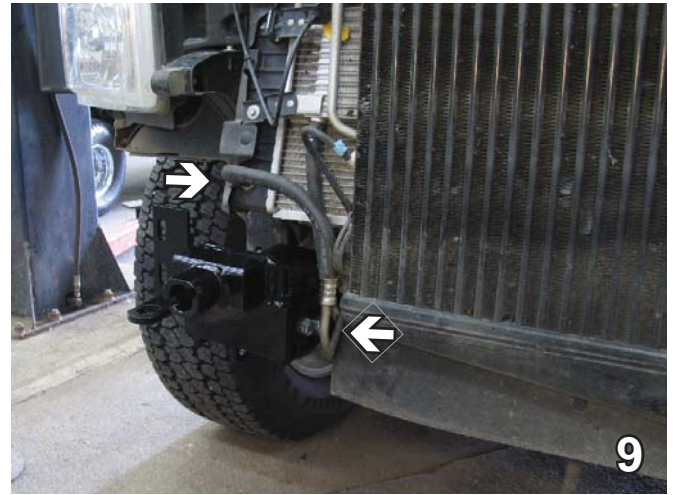
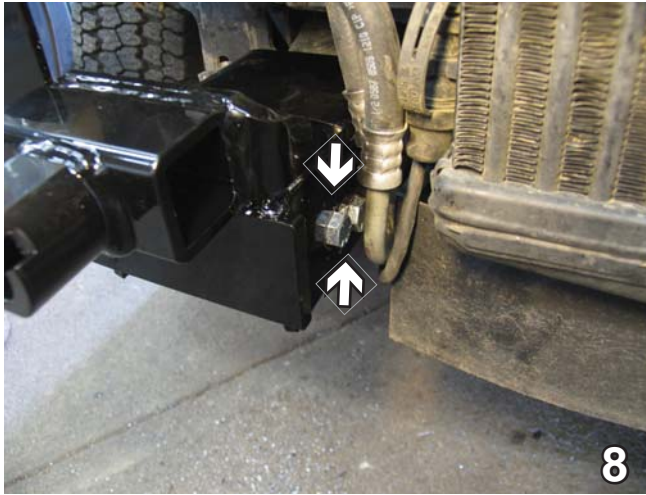

8. On the passenger side, put the nuts on the inside so they will not rub on the refrigerant lines. Insert the 1/2-13 x 1 1/2" hex bolts, 1/2" lock washers and 1/2-13 hex nuts first. On the outside, insert bolt, washer and nut in the existing hole. Install top two bolts next. Finally, drill sixth bolt hole and install bolt. Torque all bolts. Tighten with Loctite Red.
  
10. Reinstall bumper, bolts and reconnect wiring. The installation of the baseplate is complete.

Install the tow bar and safety cables according to the instructions provided in their packages. When demonstrating this to the customer, be sure to give all the contents and packages to the consumer.

Do **NOT** substitute other devices if the tow bar pins and clips are misplaced.

9. Attach the permanent baseplate safety cables to the provided convenience link on the baseplate. The photo above shows the recommended installation of the cables to frame of vehicle (see white arrow). Additional options may interfere with suggested mounting; in this case secure the cables to a solid piece of the frame as described in the instructions included with the permanent baseplate safety cables. Be sure the safety cables do not rub against any hoses or moving parts. Do this to both sides of the vehicle.

Be sure that **ALL** electrical connections are plugged in properly and functioning **BEFORE** installing the fascia.

**DEALER or INSTALLER:**  
Be certain the user receives the instruction sheets for their products.

BX2602  
2008-10 Ford F250 SD (2WD/ 4WD) Diesel  
2008-09 F450 (2WD/4WD)  
Installation Instructions



### CUSTOMER SERVICE COMMITMENT

Blue Ox is committed to providing you with exceptional customer care throughout your lifetime with our products. Our team is here to assist you with any questions you may have regarding the performance of your product. Simply call 1-800-228-9289 and you can speak with our customer care team.

Additionally, please visit our website to see which rallies our Destination America team will be attending. For a nominal fee, our service technician will service your towing system to ensure it's in proper working condition. Also as a commitment to our customers, should you visit our factory you can stay at our full service Blue Ox campground at no charge along with enjoying a factory tour.

Again thank you for being our customer and for the confidence you have shown in the performance of our products. It is because of customers like you we enjoy the success we have today.

If the baseplate is in an accident, it must be replaced. DO NOT use it again! An accident can cause unseen damage and using it again could result in more damage or serious injury. DO NOT use the baseplate if it is damaged or missing parts.



© 2008, 09 Blue Ox  
One Mill Road, Industrial Park  
Pender, Nebraska 68047  
Phone: (402) 385-3051 • Fax: (402) 385-3360  
[www.blueox.us](http://www.blueox.us)