



BX2521 2006-08 Mazda 6 Installation Instructions

Serial Number

Please read BOTH these Installation Instructions and the General Towing Instructions before attempting to install or operate this equipment.

- Blue Ox® towing products and accessories are intended to be installed by Blue Ox® Dealers who are familiar with our products and have the equipment and knowledge necessary to do “fit work”. If needed, Blue Ox® Dealers can be found at www.blueox.com or by contacting our Customer Care Department at (402) 385-3051.
- Many Blue Ox® baseplates are designed to use existing holes and hardware to mount the baseplate to the towed vehicle. Even though bolts are there, do not assume they are adequate for baseplate mounting. Always use the hardware supplied in the hardware kit and existing hardware as specified in the installation instructions.

Attachment Tab Height: 13”
Attachment Tab Width: 24”

Bolt Torque Specifications

Torque in Foot-Pounds per Metric Bolts

Bolt Size	Grade 8.8	Grade 10.9
6MM	6	8
8MM	16	22
10MM	31	40
12MM	54	70
14MM	89	117



If the front of your vehicle looks different than this, please contact us at (402)385-3051.

Reference your vehicle owner’s manual for manufacturer’s towing specifications.

Bolt Torque Specifications

Torque in Foot-Pounds per Inch Bolts

Bolt Size	Grade 5	Grade 8
1/4”	10	14
5/16”	19	29
3/8”	33	47
7/16”	54	78
1/2”	78	119
5/8”	154	230



WARNING

Failure to read and follow these instructions could result in separation of the towed vehicle from the tow bar, causing property damage, loss of towed vehicle, personal injury or death.

Parts List

Ref. No.	Qty.	Part #	Description
1	1	61-6309	BX2521 Base Plate
2	1	61-6310	BX2521 Driver Side Spacer
3	1	61-6311	BX2521 Passenger Side Spacer
4	6	61-5208	3/8"-16 Nut Plate, with 14" Wire
5	2	61-3799	1/2"-13 Nut Plate, with 10" Wire
6	2	201-0068	1/2"-13 x 1-3/4" Hex Bolt, Grd. 5, ZP
7	6	201-0444	3/8"-16 x 2" Bolt, Grd. 5, ZP
8	1	201-0368	3/8"-16 x 1 1/4" Bolt, Grd. 5, ZP
9	1	201-0419	8mm-1.25 x 50mm Hex Bolt, Grd. 8.8, ZP
10	2	201-0702	6mm-1.00 x 45mm Hex Bolt, Grd. 8.8, ZP
11	2	203-0012	1/2" Lock Washer, ZP
12	8	203-0010	3/8" Lock Washer, ZP
13	3	203-0008	1/4" Lock Washer, ZP
14	11	203-0003	3/8" Lock Washer, ZP
15	3	203-0001	1/4" Flat Washer, ZP
16	1	202-0003	3/8"-16 Hex Nut, ZP
17	1	202-0001	1/4"-20 Hex Nut, ZP
18	2	201-0979	#12-14 x 1" Self Drilling Screw, ZP
19	2	201-0192	#10-32 Hex Nut
20	2	203-0054	#10 Lock Washer
21	2	202-0047	#10-32 Hex Nut
22	2	101-5822	4 Way Connector Adapter
23	2	62-3469	Attachment, Assembly, SF/LB (R)
24	2	226-0046 (not shown)	36" Class III Safety Cables
25	2	229-0359 (not shown)	3/8" Quicklinks, ZP
26	2	290-0437 (not shown)	Cap Plug, Black
27	1	293-1339 (not provided)	Breakaway Switch
28	1	294-0805 (not provided)	4 Pin Connector
29	1	294-0902 (not provided)	6 Pin Connector
	2		Existing hex nut for air baffle-driver's side (not shown)

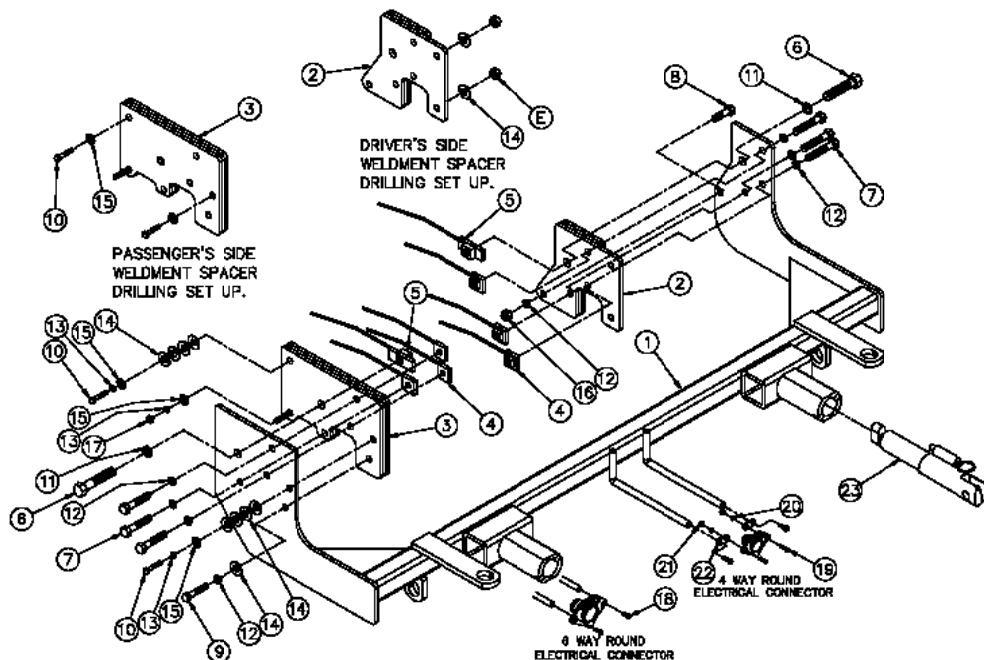

- ### Tools Required
- 8mm Socket
 - 10mm Socket
 - 12mm Socket
 - 13mm Socket
 - 7/16" Socket
 - 9/16" Socket
 - 3/4" Socket
 - 13/32" Drill Bit
 - 17/32" Drill Bit
 - Phillips Screwdriver
 - Diagonal Cutter
 - Vise Grips
 - Loctite® Red



BX2521

2006-08 Mazda 6

Installation Instructions

Attachment Tabs

Due to the design of the removable tabs, the RangeFinderII tow bar can not be used. Adapters, except the BX8833 and BX88151, can not be used with this baseplate.

Installation Notes

The fascia, headlight assemblies, metal bumper, air baffle, washer reservoir and horn bracket are removed for installation. Trimming of the grille style is required. Drilling is required.

The dimensional variations between otherwise identical vehicles can be considerable. While the baseplate was designed for easy installation, it may be necessary to tailor the baseplate slightly to compensate for auto manufacturer's tolerances. These minor adjustments may include filing a hole slightly, bending electrical rods, and/ or bending end plates.

The BX8848 4-Diode Wiring Kit is recommended for this vehicle.

Installation Instructions



1. On the top corner of fascia, remove one Phillips screw and one Phillips pushpin. Do this to both sides of the vehicle. Set screws and pushpins aside to be reinstalled later.



2. Just forward of front tire, on outside edge of wheel well, remove two Phillips pushpins. Do this to both sides of vehicle. Set pushpins aside to be reinstalled later.

BX2521

2006-08 Mazda 6

Installation Instructions



3. Push wheel well cover aside to remove one Phillips screw. Do this to both sides of the vehicle. Set screws aside to be reinstalled later.

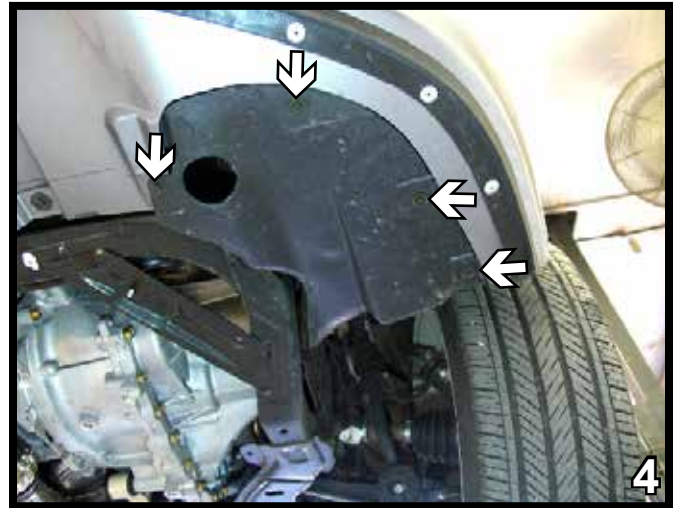

4. Remove four metric bolts just forward of front tire, underneath the wheel well, using the 8mm socket. Do this to both sides of the vehicle. Set bolts aside to be reinstalled later.



5. Using the 10mm socket, remove two metric bolts from the bottom of fascia. Pull fascia forward to remove. Set bolts and fascia aside to be reinstalled later.



6. Using the 10mm socket, remove one metric bolt from the air dam below the metal bumper. Do this to both sides of the vehicle. Set bolts and air dams aside to be reinstalled later.

BX2521

2006-08 Mazda 6

Installation Instructions



7. Using the 10mm socket, remove two metric bolts from headlight assembly's upper brackets (see white arrows). Remove one pushpin from top corner of fender (see grey arrow). Do this to both sides of the vehicle. Set bolts and pushpins aside to be reinstalled later.



8. Remove one metric bolt on side of headlight assembly using the 10mm socket. Do this to both sides of the vehicle. Set bolts aside to be reinstalled later.



9. Using the 10mm socket, remove two metric bolts from the headlight assembly's lower brackets. Pull headlight assembly forward and disconnect electrical connections. Set bolts and headlight assembly aside to be reinstalled later.

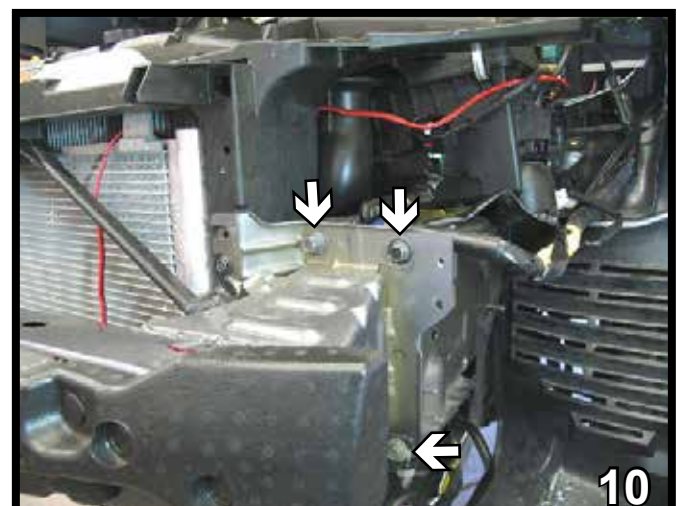

10. Using the 12mm socket, remove two metric bolts from the top of the bumper bracket and one from the lower right corner. Do this to both sides of the vehicle. Set bolts aside to be reinstalled later.

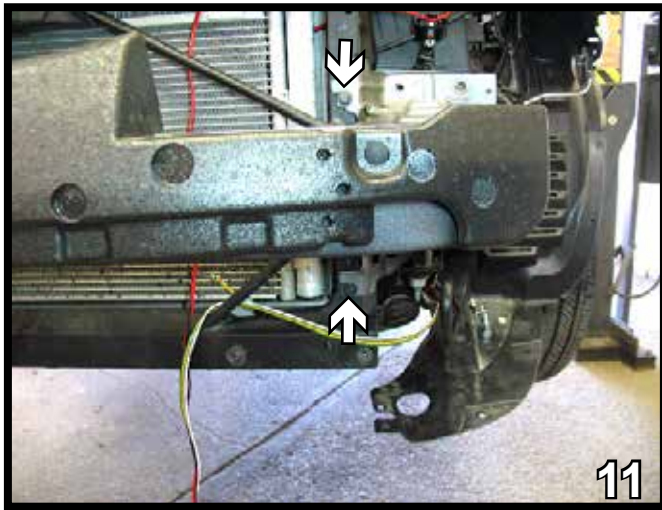

11. Using the 10mm socket, remove one metric bolt from the upper left corner of bumper bracket and one from the lower left corner. Do this to both sides of the vehicle. Set bolts aside to be reinstalled later.

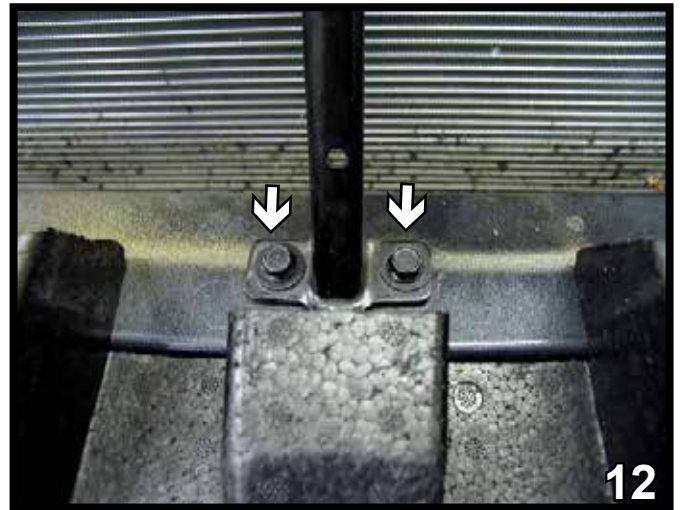

12. Using the 10mm socket, remove two metric bolts from the top of the metal bumper. Remove metal bumper. Set bolts and metal bumper aside to be reinstalled later.



13. On the driver's side, remove two metric bolts from the left side of air baffle using the 13mm socket (see white arrows). On the upper right corner of bumper bracket (see grey arrow), squeeze clips together to release wiring. Move wiring out of the way. Set bolts aside to be reinstalled later.



14. Using the 13mm socket, remove one metric bolt from the lower right corner of air baffle. Slide air baffle down and away from its upper tubing to remove. Two rubber bushings from left side of air baffle will not be reinstalled. Set bolt and air baffle aside to be reinstalled later.

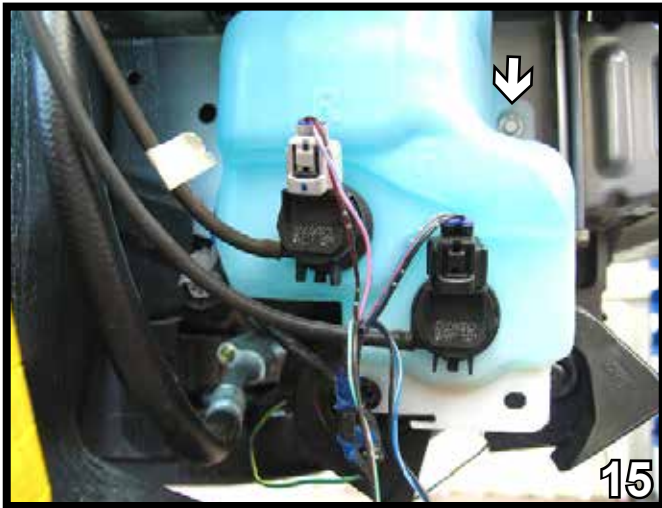

15. On the passenger's side, disconnect and plug the washer reservoir. *Note: It is recommended that the front and/or rear connections be marked in order to properly reconnect later.* Using the 10mm socket, remove the upper metric bolt of the reservoir. Set bolt aside to be reinstalled later.

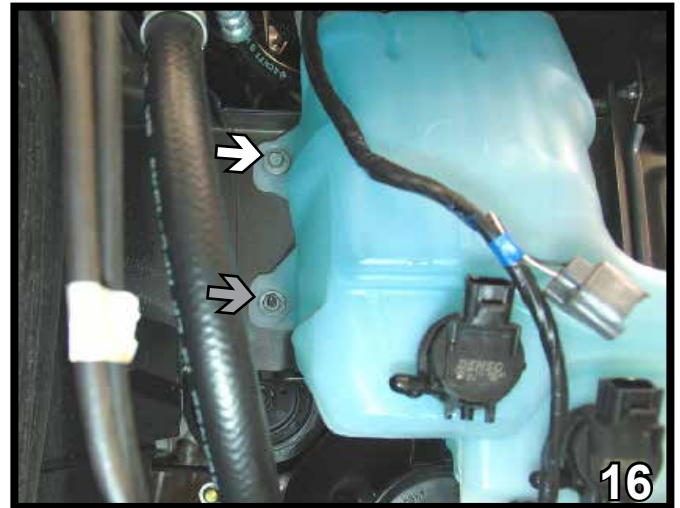

16. On the left side of reservoir, remove one metric bolt (see white arrow) and one metric nut (see grey arrow) using the 10mm socket. Set washer reservoir, bolt and nut aside to be reinstalled later.



17. Disconnect the horn wiring and, using the 12mm socket, remove one metric bolt from the horn bracket. Set horn bracket and bolt aside to be reinstalled later.



18. On the driver's side, remove a piece of tape from the center of the frame rail. Do this to both sides of the vehicle.



19. On the driver's side frame rail, align the spacer plate with the existing air baffle studs. Install the 3/8" flat washers and existing air baffle hex nuts to the air baffle studs and tighten. *Note: Actual spacer plates will be painted powder-coat black.*

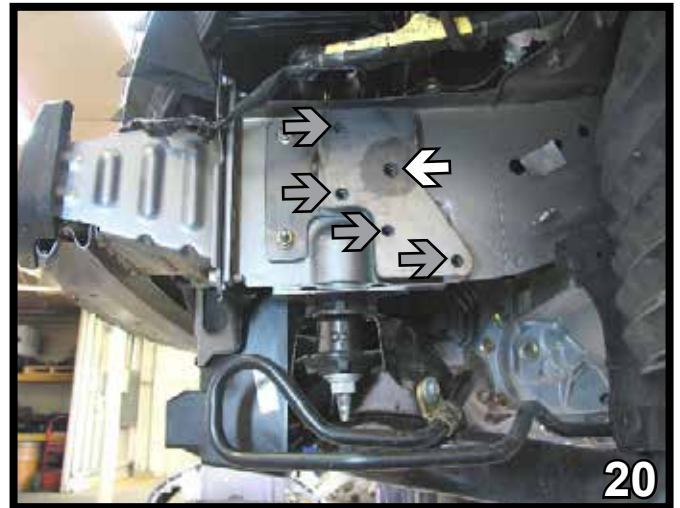

20. On the driver's side, using the spacer plate as a template, drill into the frame rail - reaming out the largest hole (see white arrow) with the 17/32" drill bit. Drill the remaining four holes into the frame rail using the 13/32" drill bit (see grey arrows).



21. On the lower left of passenger's side frame rail, use the vice grips to break off the washer reservoir stud.

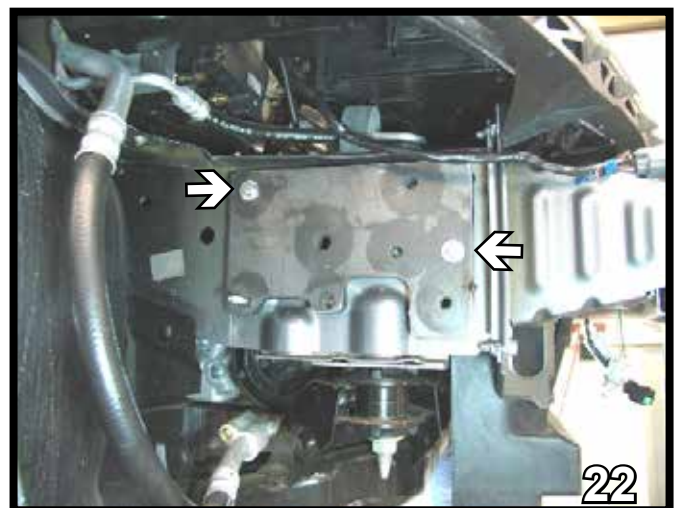

22. On the passenger's side frame rail, align the spacer plate's front hole and upper left hole with the existing holes of the frame rail (see white arrows). Install the 1/4" flat washers and 6mm hex bolts to these holes and tighten.

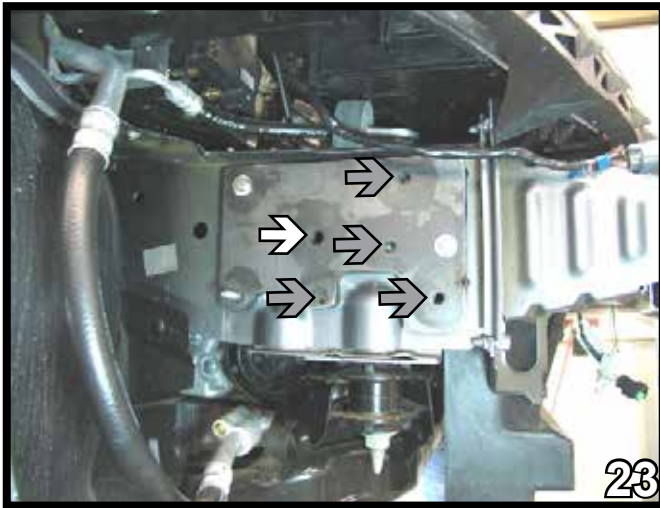

23. Using the spacer plate as a template, drill into the frame rail - reaming out the largest hole (see white arrow) with the 17/32" drill bit. Drill the remaining four holes into the frame rail using the 13/32" drill bit (see grey arrows).

BE SURE TO USE LOCTITE® RED ON ALL BOLTS BEFORE TIGHTENING. TIGHTEN ALL BOLTS ACCORDING TO THE TORQUE CHART ON THE FRONT PAGE OF THESE INSTRUCTIONS OR ON PAGE 3 OF THE BASEPLATE TOWING GENERAL INSTRUCTIONS.

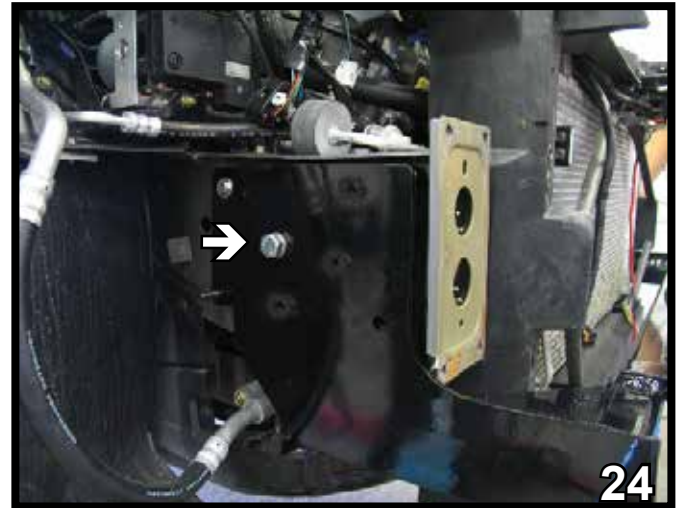

24. On passenger's side, align baseplate to spacer plate holes. Do this to both sides of vehicle. On passenger's side, insert 1/2-13 nut plate through frame end hole and align to the largest drilled hole (see white arrow). Install 1/2-13 x 1 3/4" hex bolt with 1/2" lock washer and tighten to nut plate.

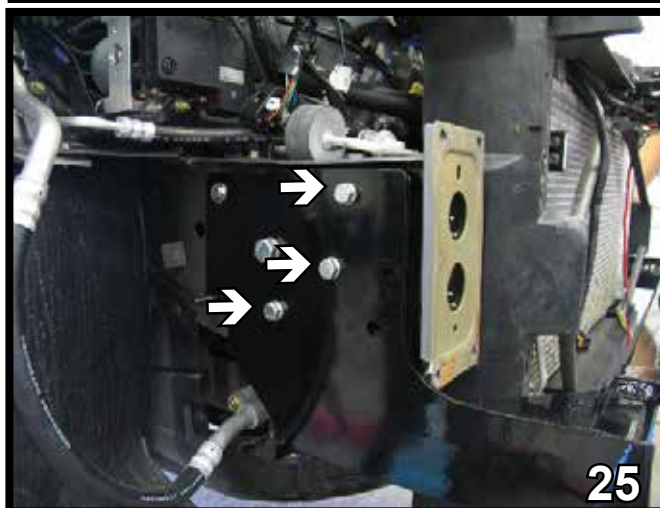

25. On passenger's side, insert 3/8-16 nut plates through frame end hole and align to the three holes nearest the largest hole. Install 3/8-16 x 2" hex bolts with 3/8" lock washers and tighten to nut plates.



26. On driver's side, align baseplate to spacer plate holes. Insert 3/8-16 nut plates through frame end hole and align to the three holes nearest the largest hole. Install 3/8-16 x 2" hex bolts with 3/8" lock washers and tighten to nut plates. Insert 1/2-13 nut plate and align to the largest drilled hole (see grey arrow). Install 1/2-13 x 1 3/4" hex bolt with 1/2" lock washer and tighten to nut plate. Trim excess nut plate wires on both sides of the vehicle. Reinstall metal bumper.

BX2521

2006-08 Mazda 6

Installation Instructions



27. Flatten the lip of the horn bracket (see inset) so that it will lie flat against the baseplate. On the passenger's side, reinstall horn bracket to its original location, using the lowest open hole of baseplate. Install 8mm hex bolt, 1/2" lock washer and 3/8" flat washer.

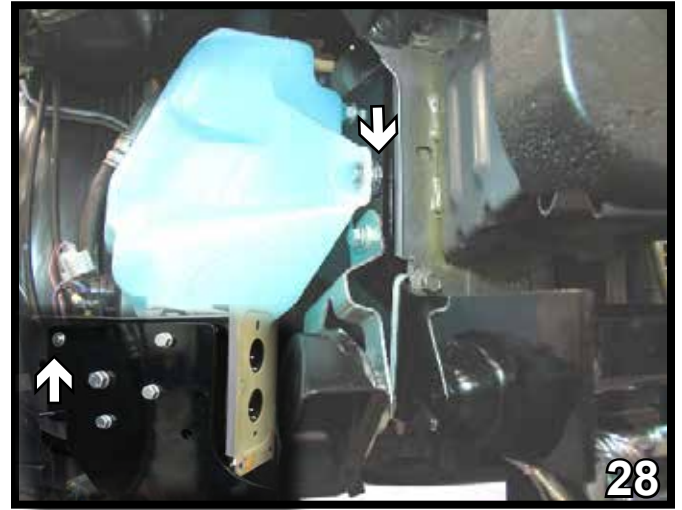

28. On the passenger's side, remove the 1/4" flat washer and 6mm hex bolt from spacer plate (see inset). Align the right side of washer reservoir to the open, front hole of baseplate. Install 6mm hex bolt, 1/4" lock washer, 1/4" flat washer and four 3/8" flat washers.

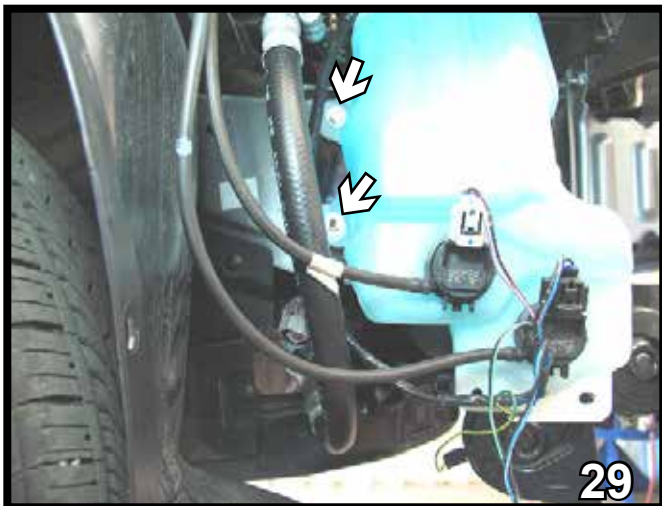

29. On the left side of reservoir, install 6mm hex bolt, 1/4" lock washer, 1/4" flat washer and four 3/8" flat washers to its upper hole (aligned with upper spacer plate hole). Install 1/4-20 hex nut, 1/4" lock washer and 1/4" flat washer to its lower hole (aligned with spacer plate stud). Reconnect electrical.

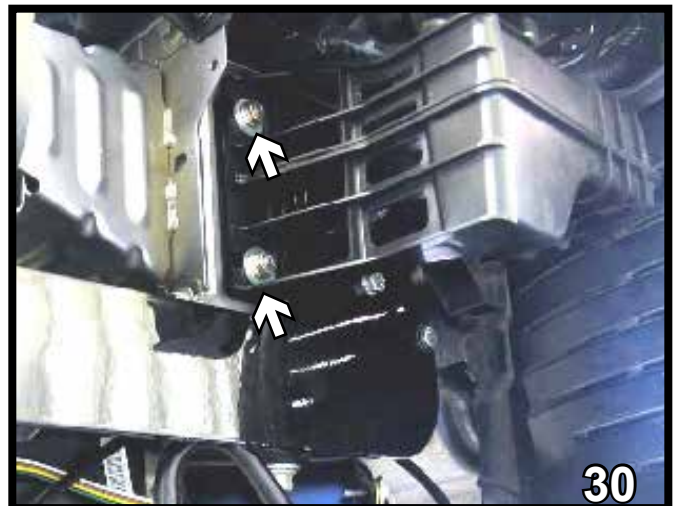

30. On the driver's side, align left side of air baffle to spacer plate holes. Reinstall air baffle's left side using the air baffle's existing hex nuts and the 3/8" flat washers and tighten (see white arrows). On the right hand side of air baffle, use its existing hex nut to fasten to the frame rail stud.



31. Align the fascia to its original position and, using the diagonal cutter, trim necessary openings in the grille style for the attachment tabs. Do this to both sides of the vehicle. Remove fascia.



32. Attach the permanent baseplate safety cables to the provided convenience link on the baseplate (see grey arrow). The photo above shows the recommended installation of the permanent baseplate safety cables to frame of the vehicle (see white arrow). If the vehicle has additional options, not shown above, which interfere with mounting the permanent baseplate safety cables, secure the cable to a solid piece of the vehicle's frame as described in the instructions included with the permanent baseplate safety cables.

DEALER or INSTALLER:

Be certain the user receives the instruction sheets for their products.

Be sure that **ALL** electrical connections are plugged in properly and functioning **BEFORE** installing the fascia.

33. Reinstall headlight assemblies and fascia.

Install the tow bar and safety cables according to the instructions provided in their packages. When demonstrating this to the customer, be sure to include all the contents and packages.

Do **NOT** substitute other devices if the tow bar pins and clips are misplaced.



BX2521 2006-08 Mazda 6 Installation Instructions



Customer Service Commitment

Blue Ox® is focused on providing exemplary customer service, as observed in our mission statement and guiding principles. In accordance with this objective, Blue Ox® is proud to provide services such as repairs and general maintenance of Blue Ox® products at over 150 RV Rallies. Look for our Destination America or Blue Ox® Racing service crews at the next rally or race that you attend. If you were not present, you will find an informative, personalized note explaining any services that may have been performed to your Blue Ox® products.

Blue Ox® also offers educational seminars at rallies and through our Park and Resort teams. In addition, Blue Ox® customers visiting our factory may take advantage of the well-equipped Blue Ox® RV park at no charge to you, our valued and appreciated customer.



© 2012 Blue Ox
One Mill Road, Industrial Park
Pender, Nebraska 68047
Phone: (402) 385-3051 • Fax: (402) 385-3360
www.blueox.us

General Information

1. Ensure that your product(s) are registered online at www.blueox.com. It is crucial to register your product(s) so that you may be alerted of product offerings, updates, upgrades, maintenance and safety bulletins, and/or recalls.
2. **It is the owner's responsibility to inspect all towing equipment for cracked welds, missing or worn parts and loose bolts before each towing trip.** Be sure to use Loctite® Red on all bolts and tighten to the recommended specifications.
3. **It is the owner's responsibility to hook up all towing equipment per manufacturer's instructions/recommendations.**
4. Remove the attachment tabs when not in use (if applicable).

Notice To Baseplate Installer

1. It is YOUR responsibility to watch for:

- Oil cooler and air conditioner lines
- Electrical wires and hoses
- Missing parts or attaching points on the frame

** If the baseplate is improperly installed and is against a wire or hose, it could cause fluid leaks or electrical shorts some time after the actual baseplate installation.

Permanent Baseplate Safety Cable Installation

Permanent baseplate safety cables are strongly recommended when towing a vehicle with a tow bar. The principle function of the permanent baseplate safety cables is to prevent the towed vehicle from breaking loose in the event the connection between the frame of the towed vehicle and the baseplate fails or becomes disconnected. The cables must be connected from the baseplate to the frame rail or cross member of the vehicle's frame. The illustrations below show the possible arrangements recommended by Blue Ox®. Each permanent baseplate safety cable must have an adequate weight rating for the towing system. The weight rating of the two (2) cables together will not qualify.

Do not mount the permanent baseplate safety cables against wires, hoses or brake lines.

These permanent baseplate safety cables should remain installed as long as the baseplate is installed on the vehicle. Permanent baseplate safety cables are to be used in conjunction with, and NOT a replacement for legally required safety cables attaching the towed vehicle to the towing vehicle.

OPTION #1

Permanent Baseplate Safety Cables to Cross Member or Frame of Towed Vehicle.

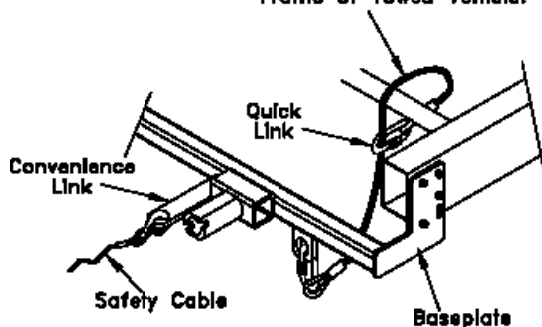

OPTION #2

Permanent Baseplate Safety Cables to Cross Member or Frame of Towed Vehicle.

