



# BX2334

## 2012-2016 Hyundai Veloster 2015-2016 Hyundai Veloster Turbo Installation Instructions

**Please read BOTH these Installation Instructions and the General Instructions prior to installing or operating this equipment.**

1. Blue Ox® towing products and accessories are intended to be installed by Blue Ox® Dealers who are familiar with our products and have the equipment and knowledge necessary to do “fit work”. If needed, Blue Ox® Dealers can be found at [www.blueox.com](http://www.blueox.com) or by contacting our Customer Care Department at (402) 385-3051.
2. Many Blue Ox® baseplates are designed to use existing holes and hardware to mount the baseplate to the towed vehicle. Even though bolts are there, do not assume they are adequate for baseplate mounting. Always use the hardware supplied in the hardware kit and existing hardware as specified in the installation instructions.



If the front of your vehicle looks different than this, please contact us at (402)385-3051.

**Attachment Tab Height: 14-1/2”**

**Attachment Tab Width: 24”**

**Serial Number**

<b>Bolt Torque Specifications</b>		
Torque in Foot-Pounds for Inch Bolts		
Bolt Size	Grade 5	Grade 8
1/4”	10	14
5/16”	19	29
3/8”	33	47
7/16”	54	78
1/2”	78	119
5/8”	154	230
3/4”	257	380

<b>Bolt Torque Specifications</b>		
Torque in Foot-Pounds for Metric Bolts		
Bolt Size	Grade 8.8	Grade 10.9
6MM	6	8
8MM	16	22
10MM	31	40
12MM	54	70
14MM	89	117
16MM	161	230
18MM	222	318

## WARNING

Failure to read and follow these instructions could result in separation of the towed vehicle from the tow bar, causing property damage, loss of towed vehicle, personal injury or death.

**Reference your vehicle owner’s manual for manufacturer’s towing specifications.**

BX2334  
2012-2015 Hyundai Veloster  
2015-2016 Hyundai Veloster Turbo  
Installation Instructions

**Instruction Notes:** The fascia, horn and bumper are removed and reinstalled for the baseplate installation. Some drilling and trimming is required.

Place all components that are removed on a flat, sturdy surface. All items will be reinstalled unless otherwise noted after the baseplate is installed.

The dimensional variations between otherwise identical vehicles can be considerable. While the baseplate was designed for easy installation, it may be necessary to tailor the baseplate slightly to compensate for vehicle manufacturer's tolerances.

The BX8869 Tail Light Wiring Kit is recommended for the Veloster model.

The BX8848 4-Diode Wiring Kit is recommended for the Veloster Turbo model.

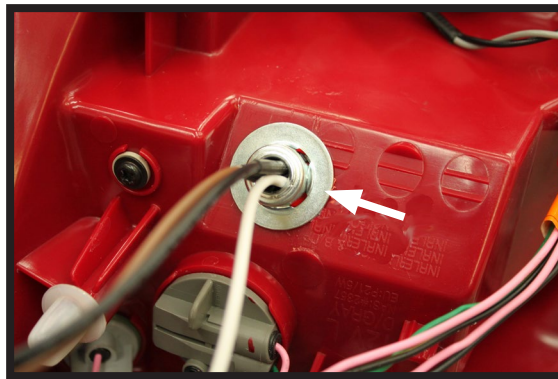

Drill a hole according to the tail  
light wiring kit instructions.

### **NOTICE**

- Handling of some cosmetic parts when installing this product may require the use of protective covers, rags, specialty tools, etc. to prevent damage.
- When using power drills be aware of the dangers of torque and drill bit length.
- When using a reciprocating saw be aware of objects behind the cutting surface.
- Use a good quality paint to spray cut edges of frame to prevent rusting.
- Be sure that **ALL** electrical connections are plugged in and accessories are functioning properly before reinstalling the fascia.
- The baseplate is computer tested to your vehicle's GVWR, exceeding this weight will void the manufacturer's warranty.
- Be sure to use a sufficient amount of Loctite® Red on all bolt threads before tightening. Tighten all bolts according to the torque chart provided.
- Dealer or installer be certain the user receives these instruction sheets.
- If the baseplate is in an accident, it must be replaced. **DO NOT** use it again! An accident can cause unseen damage and using it again could result in more damage or serious injury. **DO NOT** use the baseplate if it is damaged or missing parts.

# BX2334

## 2012-2015 Hyundai Veloster 2015-2016 Hyundai Veloster Turbo

### Installation Instructions

- Tools Required**

  - Large Vise Grip
  - Flat Screwdriver
  - Utility Knife
  - Phillips Screwdriver
  - Torque Wrench
  - Drill
  - Tape Measure
  - Loctite® RED
  - 1/4" Drill Bit
  - 3/8" Drill Bit
  - 1/2" Drill Bit
  - 10MM Socket
  - 12MM Socket
  - 7/16" Socket
  - 9/16" Socket

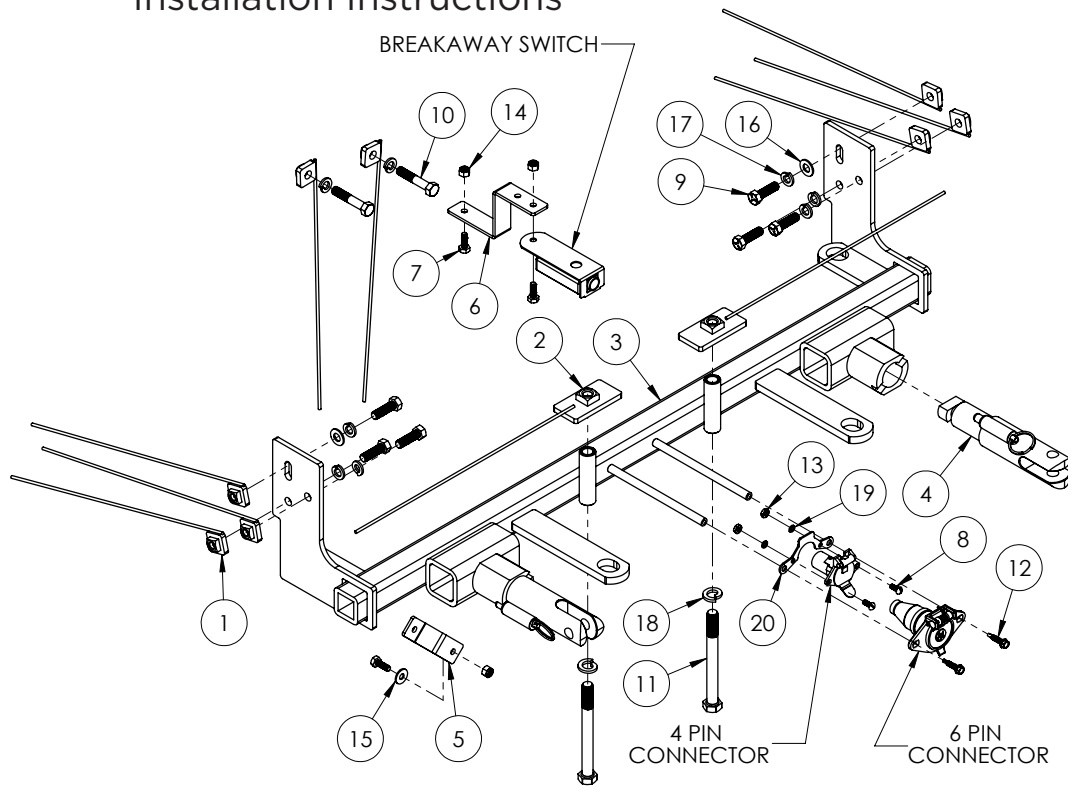

Item No.	Part No.	Description	Qty.
1.....	61-5208 .....	3/8"-16 Nut Plate w/ 14" Wire .....	8
2.....	61-5342 .....	1/2"-13 Nut Plate w/ Wire .....	2
3.....	61-6981 .....	BX2334 Baseplate Weldment .....	1
4.....	62-3468 .....	Attachment Tab Assembly .....	2
5.....	102-7195 .....	Bracket .....	1
6.....	102-7297 .....	Breakaway Bracket .....	1
7.....	201-0050 .....	1/4"-20 X 3/4" Hex Head Bolt, Grade 5, ZP.....	3
8.....	201-0192 .....	#10-32 x 1/2" Round Slotted Head Screw.....	2
9.....	201-0368 .....	3/8"-16 x 1-1/4" Hex Head Bolt, Grade 5, ZP .....	6
10.....	201-0444 .....	3/8"-16 x 2" Hex Head Bolt, Grade 5, ZP .....	2
11.....	201-0786 .....	1/2"-13 x 5" Hex Head Bolt, Grade 5, ZP .....	2
12.....	201-0979 .....	#12-14 x 1" Self Drilling Screw, ZP.....	2
13.....	202-0047 .....	#10-32 Hex Nut .....	2
14.....	202-0102 .....	1/4"-20 Hex Nylon Lock Nut, ZP.....	3
15.....	203-0001 .....	1/4" Flat Washer, ZP.....	3
16.....	203-0003 .....	3/8" Flat Washer, ZP.....	2
17.....	203-0010 .....	3/8" Lock Washer, ZP.....	8
18.....	203-0012 .....	1/2" Lock Washer, ZP.....	2
19.....	203-0054 .....	#10 Lock Washer, ZP .....	2
20.....	299-0685 .....	Electrical Bracket.....	1
21.....	226-0046(not shown) .....	36" Class III Safety Cable.....	2
22.....	229-0359(not shown) .....	3/8" Quicklink , ZP .....	2
23.....	290-0437(not shown) .....	Black Cap Plug Receiver.....	2

**Important:**

Use only genuine factory replacement parts on your baseplate. Do **NOT** substitute homemade or non-typical parts. If a bolt is lost or in need of replacement, for your safety and the preservation of your baseplate, be sure to use a replacement bolt of the same grade (In most cases it will be Grade 5, please reference the parts list above). Replacement parts may be ordered through your nearest Blue Ox® Dealer or Distributor. Failing to follow and/or altering these installation instructions in either installation or required equipment will void the manufacturer's warranty. Towing behind a non-motorized vehicle will void the warranty.

BX2334  
2012-2015 Hyundai Veloster  
2015-2016 Hyundai Veloster Turbo  
Installation Instructions

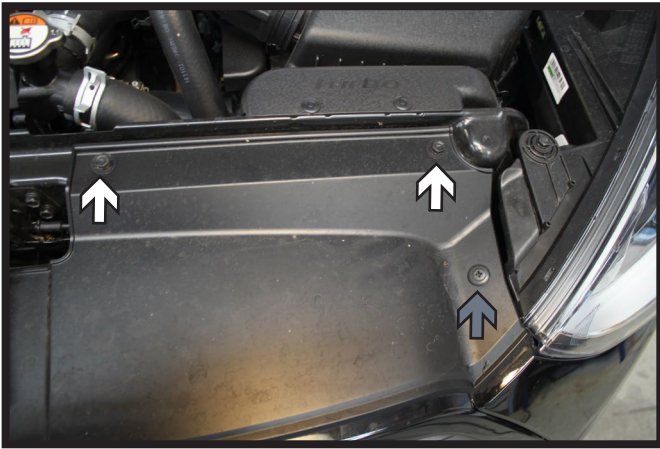

1. Along the top edge of the fascia, using a 10MM socket, remove the four (4) screws. There are two (2) on each side (white). Remove the two (2) push pins, one (1) from each side (gray).



2. Using a 10MM socket, remove the screw in the wheel well at the fascia/fender joint. Do this on both sides of the vehicle.

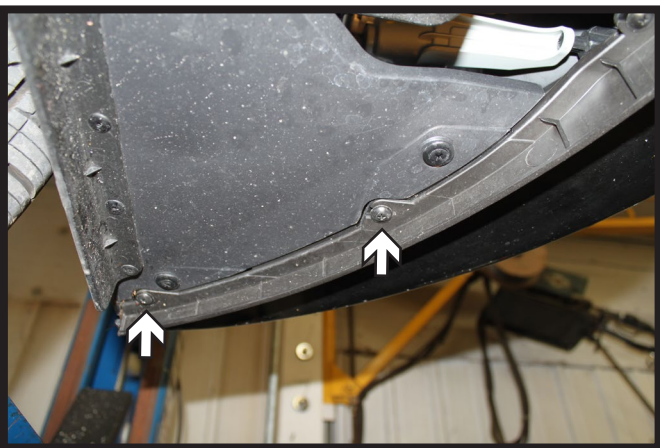

3. Using a phillips screwdriver, remove the six (6) screws from the underside of the fascia. There are two (2) on each side and two (2) in the middle. Pull the corners of the fascia away from the vehicle disconnecting any electrical connections and set the fascia aside.

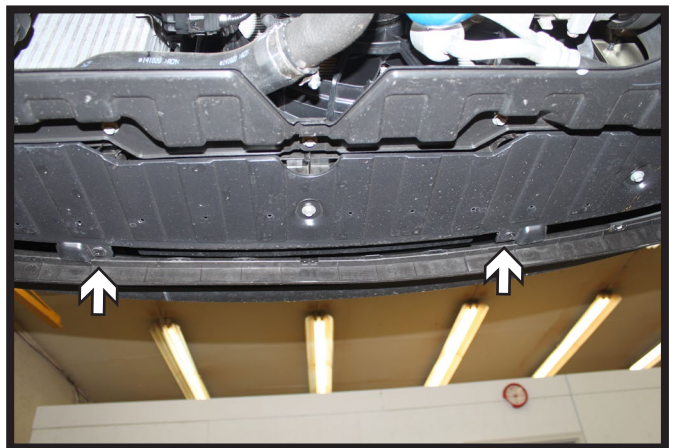

BX2334  
2012-2015 Hyundai Veloster  
2015-2016 Hyundai Veloster Turbo  
Installation Instructions

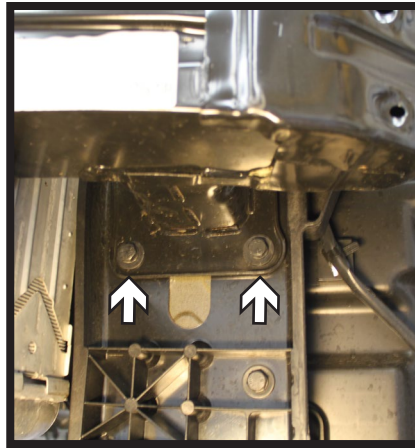
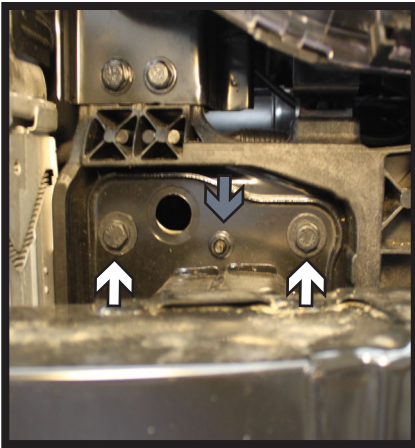

4. Using a 12MM socket, remove the eight (8) bolts from the bumper. There are four (4) on each side (white). Using a 10MM socket, remove the two (2) nuts from the top side of the bumper. There is one (1) on each side. Set the bumper aside.

**Turbo Models:** Using a 10MM socket, remove the bolt from the center brace prior to bumper removal.

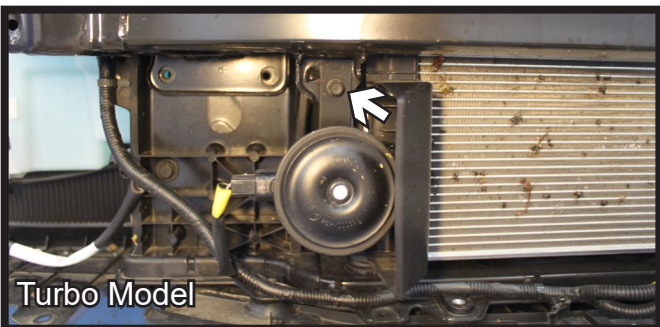
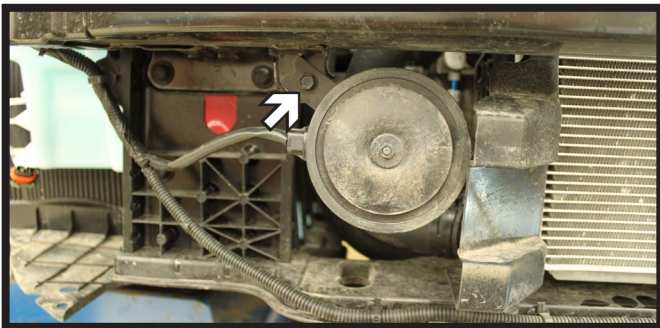

5. Using a 10MM socket, remove the screw from the horn bracket and set the horn aside.

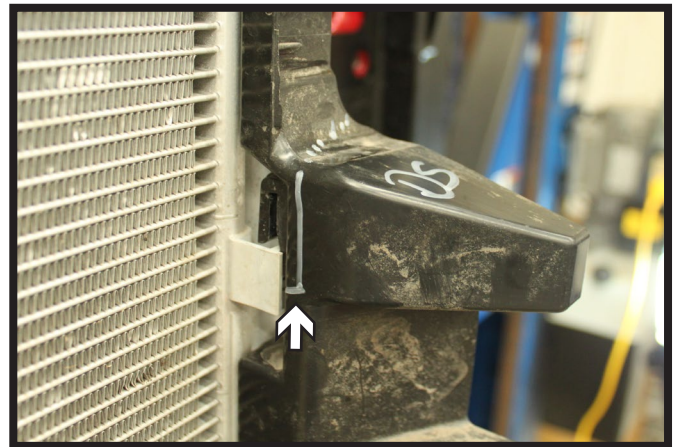

6. **Non-Turbo Models:** Trim off the lower plastic shielding as shown. Do this on both sides of the vehicle.

Note: be aware of the aluminum protrusion behind the plastic when trimming.

BX2334  
2012-2015 Hyundai Veloster  
2015-2016 Hyundai Veloster Turbo  
Installation Instructions

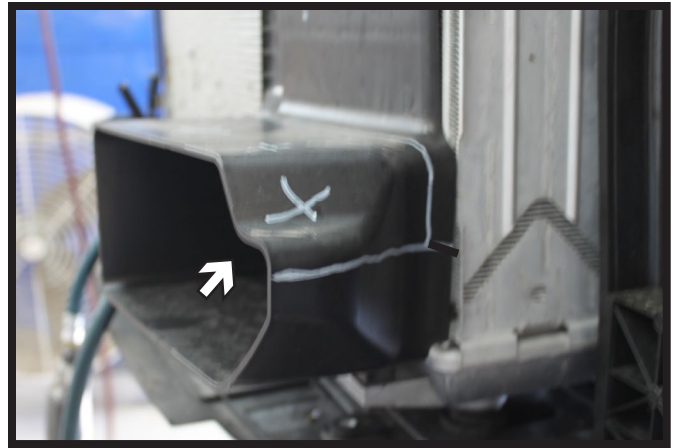
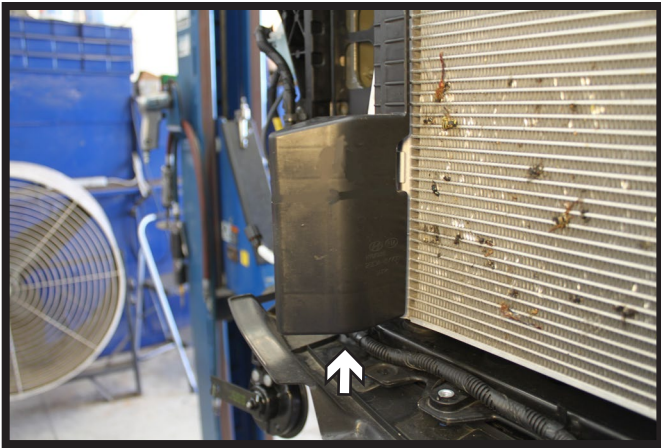

5. **Turbo Models:** Remove the vertical plastic radiator shielding (left). Do this on both sides of the vehicle.  
On the driver side, trim the intake tube as shown for baseplate clearance (right).

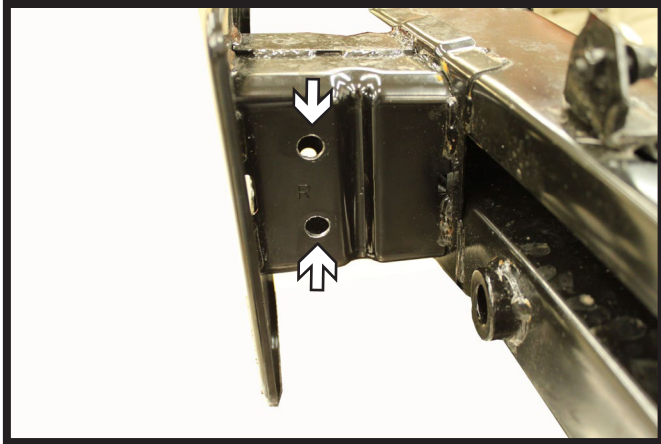

6. Using a 3/8" drill bit, ream out the existing holes on the inside of the bumper. Do this on both sides of the bumper.



7. With the bumper upside down, install the baseplate onto the bumper using the 3/8" hardware. Do this on both sides of the bumper. Fully tighten all hardware.

**\*\* Use Loctite® Red on all bolt threads and tighten all bolts to the appropriate torque. \*\***

BX2334  
2012-2015 Hyundai Veloster  
2015-2016 Hyundai Veloster Turbo  
Installation Instructions

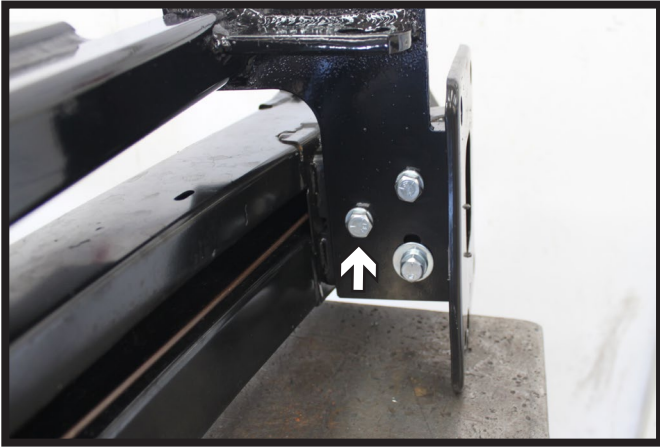

8. Using a 3/8" drill bit, drill the front hole in the baseplate thru the bumper and install the 3/8" hardware. Do this on both sides of the bumper. Fully tighten all hardware.

**\*\* Use Loctite® Red on all bolt threads and tighten all bolts to the appropriate torque. \*\***

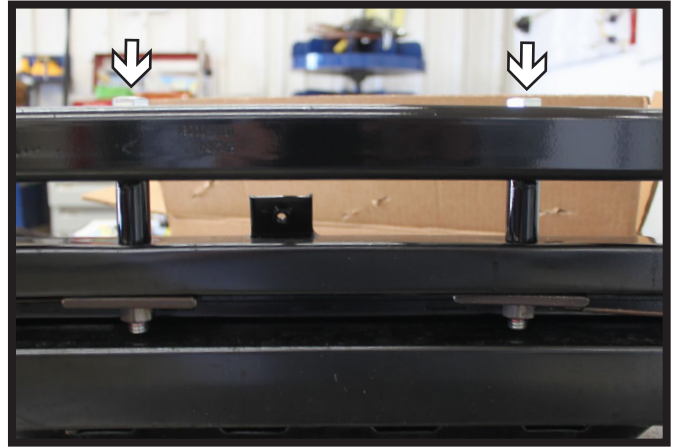

9. Using a 1/2" drill bit, drill the middle holes in the baseplate thru the bumper and install the 1/2" hardware. Fully tighten all hardware.

**\*\* Use Loctite® Red on all bolt threads and tighten all bolts to the appropriate torque. \*\***

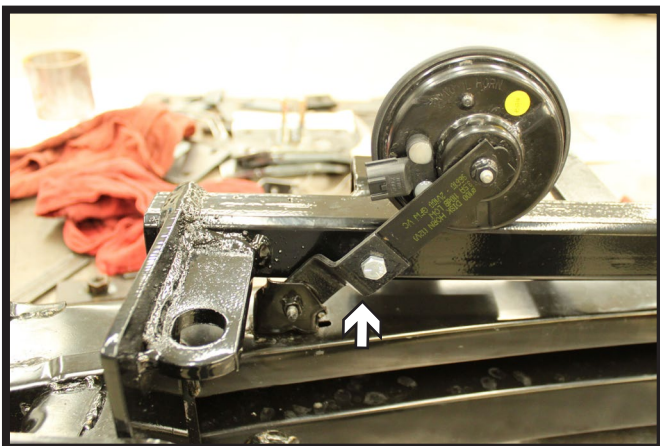

10. **Non-Turbo Models:** Reinstall the horn bracket to the bumper using the extension bracket provided.

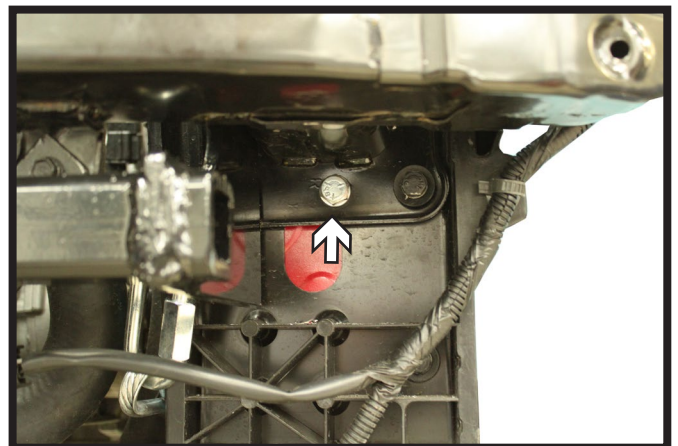

11. Reinstall the bumper/baseplate back onto the vehicle using the existing bolts/nuts. Using a 3/8" drill bit, drill a hole thru the bumper/frame in between the lower two (2) bolts and install the 3/8" hardware. Do this on both sides of the bumper. Fully tighten all hardware.

**\*\* Use Loctite® Red on all bolt threads and tighten all bolts to the appropriate torque. \*\***

BX2334  
2012-2015 Hyundai Veloster  
2015-2016 Hyundai Veloster Turbo  
Installation Instructions

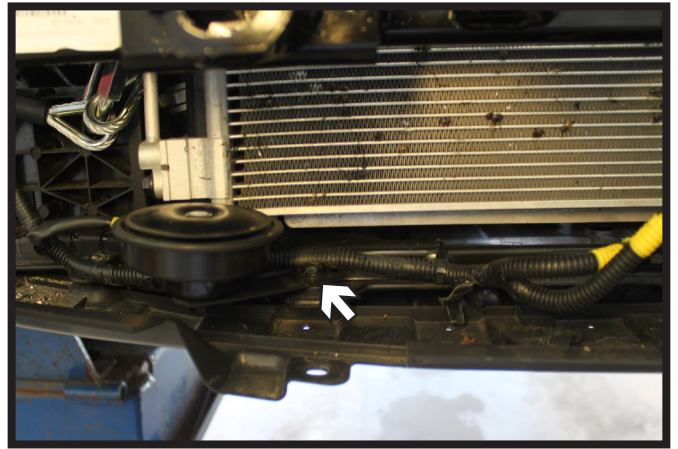
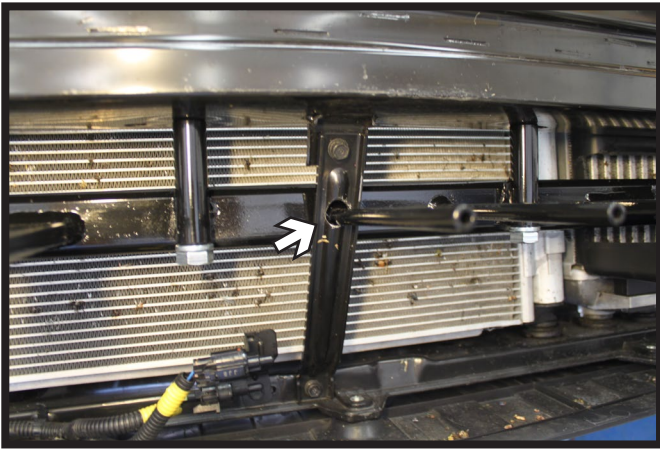

12. **Turbo Models:** Mark the bumper center brace and drill a 1/2" hole thru it to go around the electrical rod. Reinstall the brace to the bumper (left). Reinstall the horn to the existing bolt location on the left side of the intercooler (right).

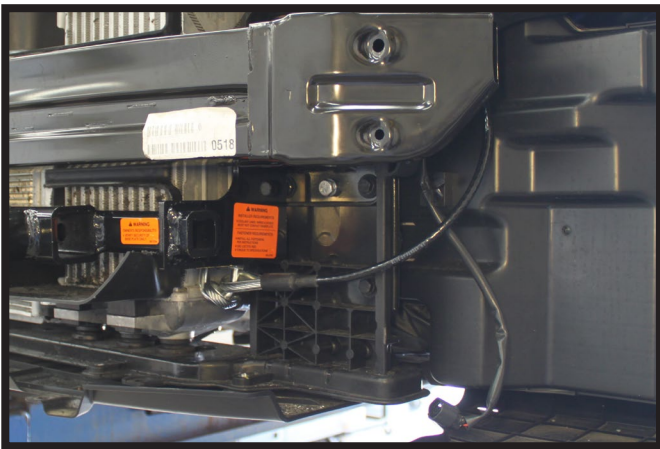

13. Attach the permanent baseplate safety cables to the provided convenience link on the baseplate. The photo above shows the recommended installation of the cables to frame of vehicle. Additional options may interfere with suggested mounting; in this case, secure the cables to a solid piece of the frame as described in the General Information sheet. Be sure the safety cables do not rub against any hoses or moving parts. Do this on **BOTH** sides of the vehicle.

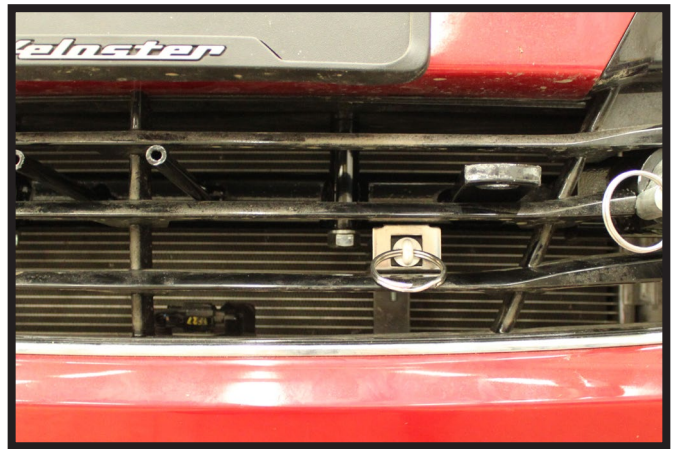

14. **Optional Breakaway:** Drill a 1/4" hole in the lower cross bar at the desired location and install the bracket & breakaway with the 1/4" hardware provided.



BX2334  
2012-2015 Hyundai Veloster  
2015-2016 Hyundai Veloster Turbo  
Installation Instructions



15. Hold the fascia as close to its original position, mark and trim the fascia around the convenience links and attachment tabs. Reinstall the fascia.

## CUSTOMER SERVICE COMMITMENT

Blue Ox® is committed to providing you with exceptional customer care throughout your lifetime with our products. Our team is here to assist you with any questions you may have regarding the performance of your product. Simply call (402) 385-3051 and you can speak with our technical service team.

Additionally, please visit our website to see which rallies our Destination America team will be attending. For a nominal fee, our service technician will service your towing system to ensure it's in proper working condition. Also, as a commitment to our customers, should you visit our factory, you can stay at our full service Blue Ox® campground at no charge along with enjoying a factory tour.

Again, thank you for being our customer and for the confidence you have shown in the performance of our products. It is because of customers like you we enjoy the success we have today.

© 2016 Blue Ox  
One Mill Road, Industrial Park  
Pender, Nebraska 68047  
Phone: (402) 385-3051  
Fax: (402) 385-3360  
[www.blueox.com](http://www.blueox.com)

# General Information

1. Ensure that your product(s) are registered online at [www.blueox.com](http://www.blueox.com). It is crucial to register your product(s) so that you may be alerted of product offerings, updates, upgrades, maintenance and safety bulletins, and/or recalls.
2. **It is the owner's responsibility to inspect all towing equipment for cracked welds, missing or worn parts and loose bolts before each towing trip.** Be sure to use Loctite® Red on all bolts and tighten to the recommended specifications.
3. **It is the owner's responsibility to hook up all towing equipment per manufacturer's instructions/recommendations.**
4. Remove the attachment tabs when not in use (if applicable).

## Notice To Baseplate Installer

### 1. It is YOUR responsibility to watch for:

- Oil cooler and air conditioner lines
- Electrical wires and hoses
- Missing parts or attaching points on the frame

\*\* If the baseplate is improperly installed and is against a wire or hose, it could cause fluid leaks or electrical shorts some time after the actual baseplate installation.

## Permanent Baseplate Safety Cable Installation

Permanent baseplate safety cables are strongly recommended when towing a vehicle with a tow bar. The principle function of the permanent baseplate safety cables is to prevent the towed vehicle from breaking loose in the event the connection between the frame of the towed vehicle and the baseplate fails or becomes disconnected. The cables must be connected from the baseplate to the frame rail or cross member of the vehicle's frame. The illustrations below show the possible arrangements recommended by Blue Ox®. Each permanent baseplate safety cable must have an adequate weight rating for the towing system. The weight rating of the two (2) cables together will not qualify.

***Do not mount the permanent baseplate safety cables against wires, hoses or brake lines.***

These permanent baseplate safety cables should remain installed as long as the baseplate is installed on the vehicle. Permanent baseplate safety cables are to be used in conjunction with, and NOT a replacement for legally required safety cables attaching the towed vehicle to the towing vehicle.

### OPTION #1

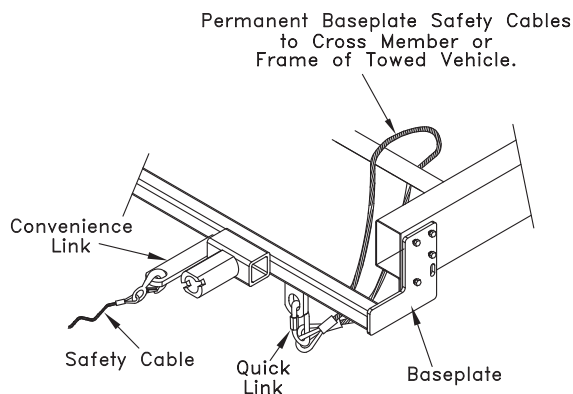

### OPTION #2

