



BLUE OX®

Baseplate Installation Instructions

BX2324

2007-09 Hyundai Santa Fe Installation Instructions

Serial Number

Please read BOTH these Installation Instructions and the General Towing Instructions before attempting to install or operate this equipment.

1. Blue Ox® towing products and accessories are intended to be installed by Blue Ox® Dealers who are familiar with our products and have the equipment and knowledge to do “fit work.” When necessary, Blue Ox® Dealers can be found at www.blueox.com or by contacting our Customer Care Department at (402) 385-3051.

Attachment Tab Height: 23”
Attachment Tab Width: 24”

2. Many Blue Ox® Baseplates are designed to use existing holes and hardware to mount the baseplate to the towed vehicle. Even though bolts are there, do not assume they are adequate for baseplate mounting. Always use hardware supplied in the hardware kit or existing hardware specified in the Baseplate Towing Installation Instructions.

Bolt Torque Specifications

Torque in Foot-Pounds for Metric Bolts

Bolt Size	Grade 8.8	Grade 10.9
6MM	6	8
8MM	16	22
10MM	31	40
12MM	54	70
14MM	89	117

Confirm the towability and pre-towing procedures for your vehicle with the owner’s manual or contact the vehicle’s manufacturer for specific towing procedures.

Bolt Torque Specifications

Torque in Foot-Pounds for Inch Bolts

Bolt Size	Grade 5	Grade 8
1/4”	10	14
5/16”	19	29
3/8”	33	47
7/16”	54	78
1/2”	78	119
5/8”	154	230

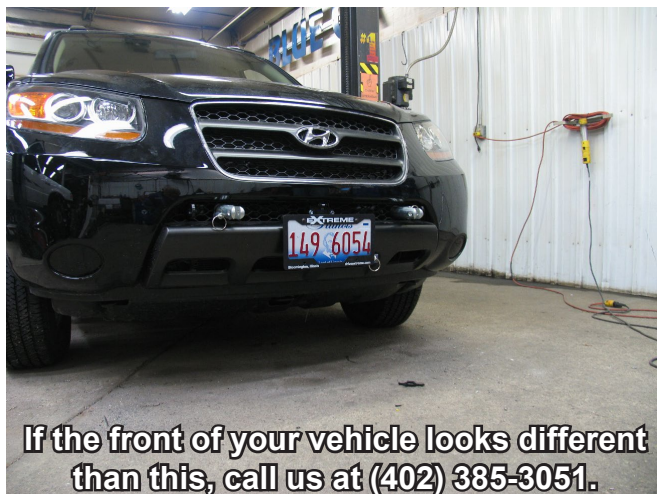

If the front of your vehicle looks different than this, call us at (402) 385-3051.

! WARNING

Failure to read and follow these instructions could result in separation of the towed vehicle from the tow bar, causing property damage, loss of towed vehicle, personal injury or death.

BX2324

2007-09 Hyundai Santa Fe

Installation Instructions

Parts List

Ref. No.	Qty.	Part #	Description
1	1	61-6375	Weldment, Baseplate, BX2324
2	1	61-6332	Weldment, DS Spacer, BX2324
3	1	61-6333	Weldment, PS Spacer, BX2324
4	4	61-5208	Weldment, Nut Plate, 1/4x1x1, 3/8" Bolt Wire
5	1	102-6807	Condenser Support, BX2324
6	8	201-0336	3/8-16 X 2 1/2 Hex Bolt Grd. 5 ZP.
7	8	203-0010	3/8" Lock Washer, ZP
8	4	202-0003	3/8-16 Hex Nut, ZP
9	3	201-0050	1/4-20x3/4" Hex Bolt, Grd. 5, ZP
10	3	202-0069	1/4-20 Hex Flange Whiz Lock Nut, ZP
11	2	201-0979	#12-14 x 1" Self Drilling Screw, ZP
12	2	201-0192	#10-32x1/2" Slot, Round Head Screw
13	2	203-0054	#10 Lock Washer
14	2	202-0047	#10-32 Hex Nut
15	2	101-5822	Adapter, 4 Way Connector
16	2	62-3468	Attachment, Assembly, SF/SB, 1 Hole
	2	290-0437	Cap Plug, Black (Not Shown)
	2	229-0359	Quicklink, 3/8", ZP (Not Shown)
	2	226-0046	Baseplate Safety Cable, 36" Class III (Not Shown)

Tools Required

Loctite® RED
 10MM Socket
 12MM Socket
 13/32 Drill Bit
 1 1/4" Hole Saw
 Diagonal Cutters
 Reciprocating Saw
 Phillips Screwdriver

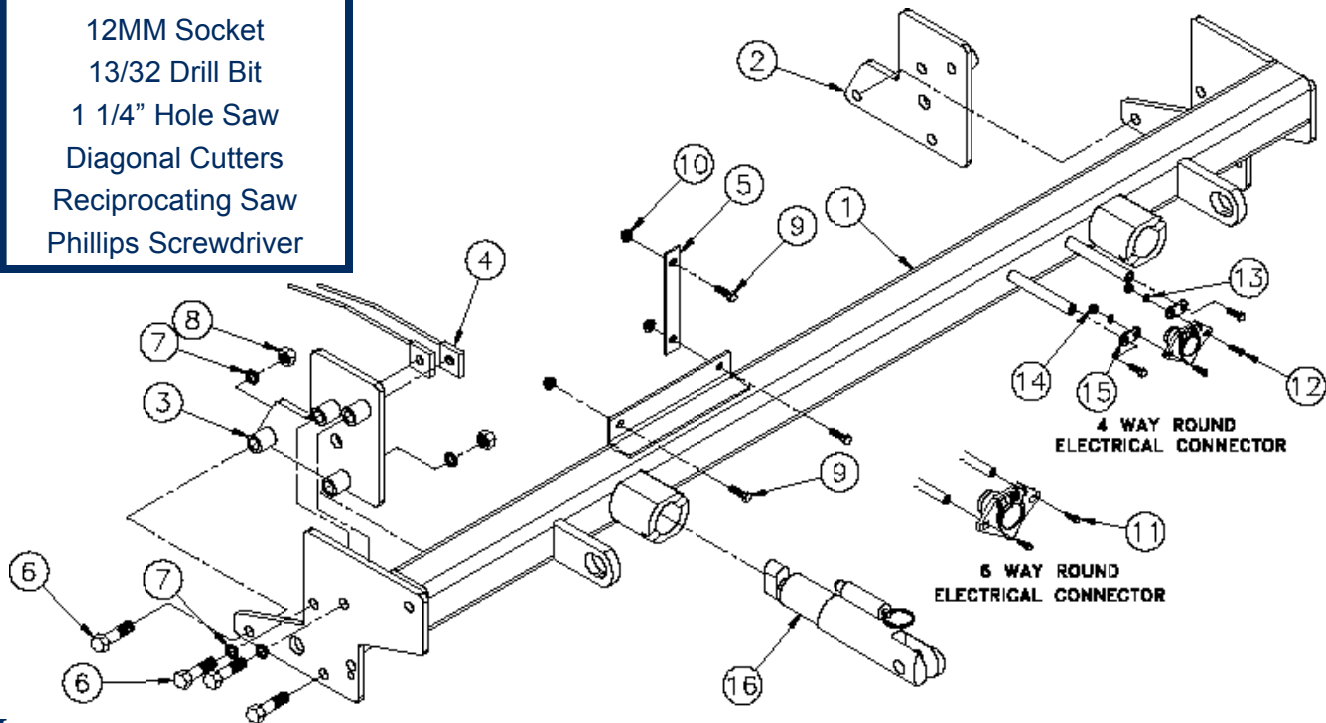

Important:

Use only genuine factory replacement parts on your baseplate. Do **NOT** substitute homemade or non-typical parts. If a bolt is lost or in need of replacement, for your safety and the preservation of your baseplate, be sure to use a replacement bolt of the same grade (In most cases it will be Grade 5, please reference the parts list above). Replacement parts may be ordered through your nearest Blue Ox® Dealer or Distributor. Failing to follow and/or altering these installation instructions in either installation or required equipment will void the manufacturer's warranty. Towing behind a non-motorized vehicle will void the warranty.

2007-09 Hyundai Santa Fe

Installation Instructions

Vehicle Weight:

Due to the design of the removable tabs, the RangeFinderII tow bar can not be used. Adapters, except the BX8833 and BX88151, can not be used with this baseplate.

Installation Notes: The fascia metal bumper and air baffle are removed and reinstalled during installation of the baseplate. Drilling is required. Trimming of the fascia is required.

The dimensional variations between otherwise identical vehicles can be considerable. While the baseplate was designed for easy installation, it may be necessary to tailor the baseplate slightly to compensate for auto manufacturer's tolerances. These minor adjustments may include filing a hole slightly, bending electrical rods or bending end plates.

The BX8869 Bulb and Socket Wiring Kit is recommended for this vehicle.



Possible Location of the BX8869 Bulb & Socket Wiring Kit

Handling of some cosmetic parts when installing this product may require the use of protective covers, rags, specialty tools, etc. to prevent damage.

Installation Instructions:

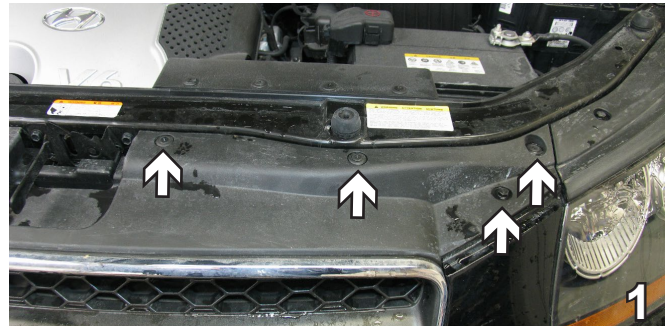

1. Using a Phillips screwdriver, remove three plastic Phillips push pins and then using a 10MM socket, remove one metric bolt. They are all located on the top edge of the fascia on the black plastic piece. Do this to both sides of the vehicle. Set push pins and bolts aside to be reinstalled later.



2. Using a Phillips screwdriver, remove one metric bolt just forward of the front tire, on wheel well. Do this to both sides of the vehicle. Set bolts aside to be reinstalled later.



3. Using a Phillips screwdriver, remove two plastic Phillips push pins from just forward the front tire underneath. Do this to both sides of the vehicle. Set push pins aside to be reinstalled later.

BX2324
2007-09 Hyundai Santa Fe
Installation Instructions



4. Using a Phillips screwdriver, remove three plastic Phillips push pins located in the middle underneath. The fascia is then ready to be removed from the vehicle. Set fascia and push pins aside carefully to be reinstalled later.



6. Using a 10MM socket, remove one bolt and release the clip from the wire harness, so it can be moved out of the way. Do this to both sides of the vehicle. Set bolts aside to be reinstalled later.

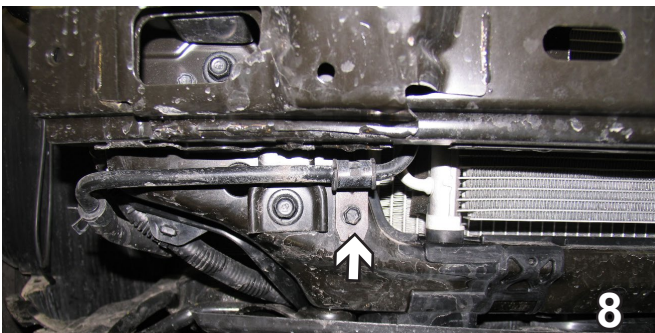

8. On the passenger side, using a 10MM socket, remove one metric bolt located underneath the metal bumper on the passenger side of the vehicle. Set bolt aside to be reinstalled later.

5. Using a 10MM socket, remove two metric bolts from the air baffle located on the driver side of the vehicle. Set air baffle and bolts aside to be reinstalled later.

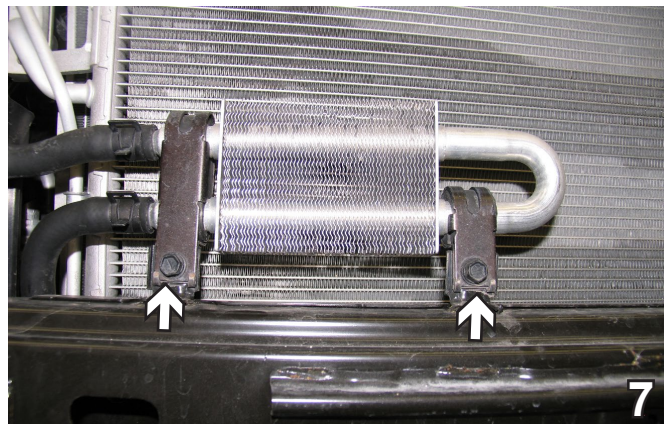

7. Using a 10MM socket, remove two metric bolts from the cooling condenser located on the passenger side of the vehicle. Please discard the bolts, because they will not be reinstalled later.

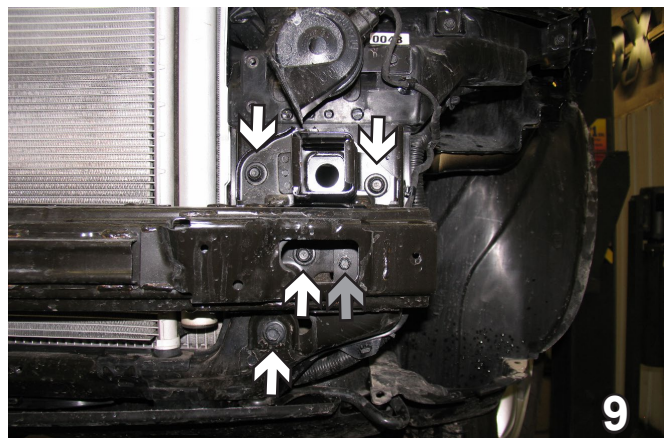

9. Using a 12MM socket, remove four metric bolts from the metal bumper (see white arrows) and then using a 10MM socket, remove one metric bolt from the inside of the metal bumper (see grey arrow). Do this to both sides of the vehicle. Set metal bumper and bolts aside to be reinstalled later.

BX2324
2007-09 Hyundai Santa Fe
Installation Instructions

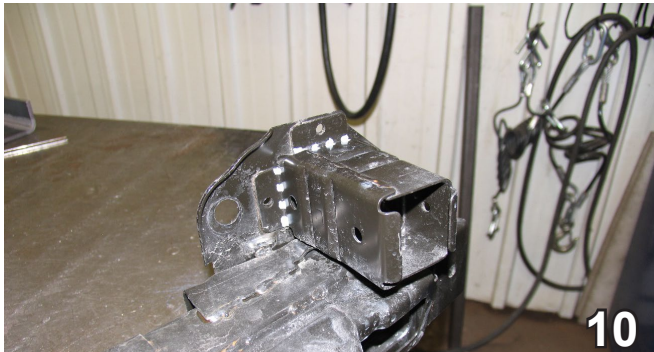

10. Using a reciprocating saw, cut bumper horn off flush with the base. Please refer to the photo above for reference. Do this to both sides of the metal bumper.

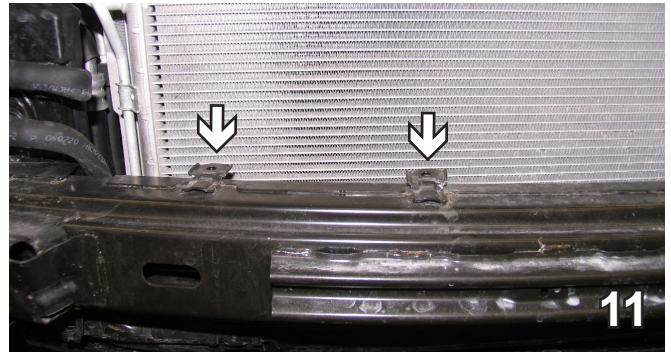

11. Using a hammer, bend over the tabs that the coolant lines were attached to located on top of the metal bumper on the passenger side.

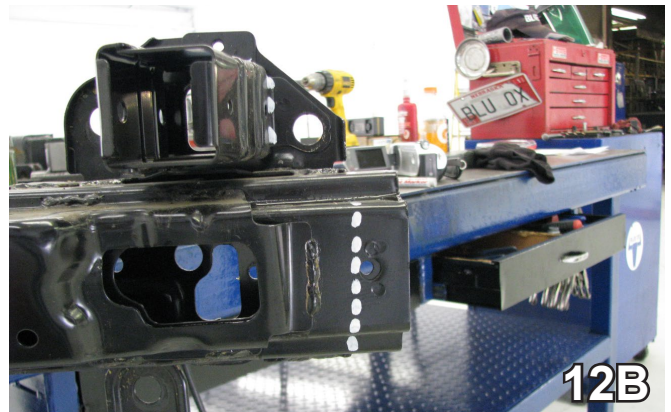
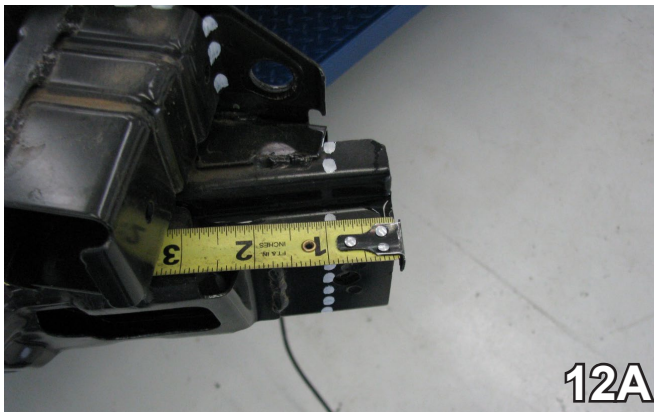

12. Using a reciprocating saw, cut off the end of the metal bumper. Do this to both sides of the vehicle.



13. Using a 1 1/4" hole saw, drill a hole into the frame as shown. This needs to be done so that the top two bolts of the metal bumper can be reinstalled after the spacer plates are put on. Do this to both sides of the vehicle.

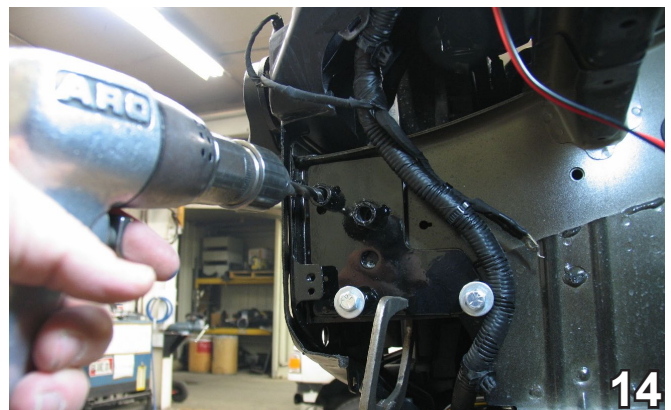

14. Slide the spacer plate into place and line it up flush with the bottom and then slide as far forward as it will go. Clamp plate in place with vise grips. Using the spacer plate as a template, drill out the holes using a 13/32" drill bit. Do this to both sides of the vehicle.

When using power drills be aware of the dangers of torque and drill bit length.

2007-09 Hyundai Santa Fe

Installation Instructions

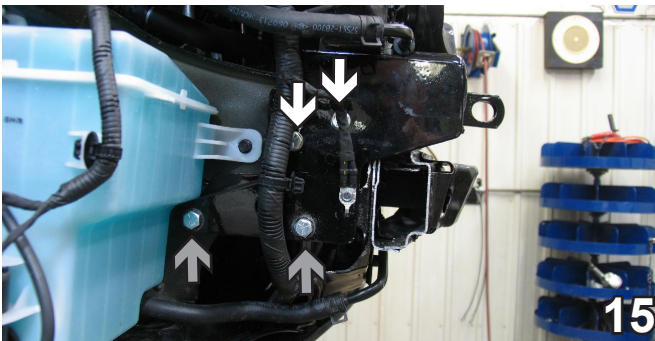

15. Fasten the convenience link onto the baseplate before it is installed. Slide the baseplate into place lining up the holes of the baseplate with the holes of the spacer plate. Insert the nut plates into the frame and line up with the top drilled holes. Insert a 3/8-16 x 2 1/2" hex bolt with a 3/8" lock washer into the top two holes and tighten down with a 3/8" nut plate (see white arrows). You will then insert a 3/8-16 x 2 1/2" hex bolt with a 3/8" lock washer into the bottom two holes and tighten down with a 3/8-16 hex nut (see grey arrows). Do this to both sides of the vehicle.

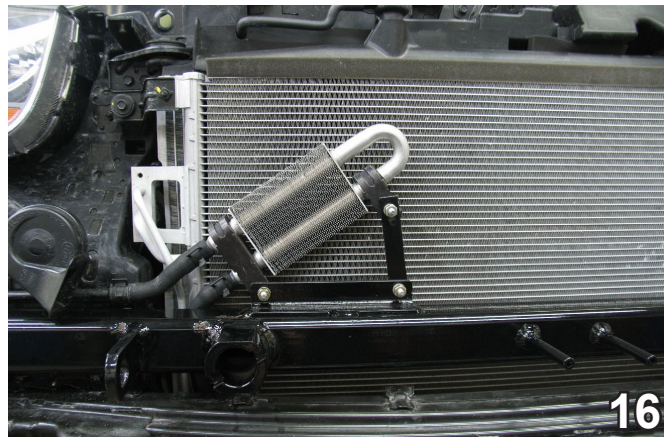

16. Reposition coolant line according to the photo above by using a condenser support and then tightening is down with 1/4-20 x 3/4" hex bolts and 1/4-20 hex flange whiz lock nuts.

BE SURE TO USE LOCTITE® RED ON ALL BOLTS BEFORE TIGHTENING. TIGHTEN ALL BOLTS ACCORDING TO THE TORQUE CHART ON THE FRONT PAGE OF THESE INSTRUCTIONS OR ON PAGE 3 OF THE BASEPLATE TOWING GENERAL INSTRUCTIONS.

17. Reinstall the metal bumper using the five existing bolts removed in step 9. Do this to both sides of the vehicle. Then reinstalled the air baffle and bolts removed in step 5.

Be sure that **ALL** electrical connections are plugged in properly and functioning **BEFORE** installing the fascia.

19. Align the fascia to its original position and using a side cutters, remove area around attachment tab receiver and convenience link to allow for it to come through the fascia. Do this to both sides of the vehicle.

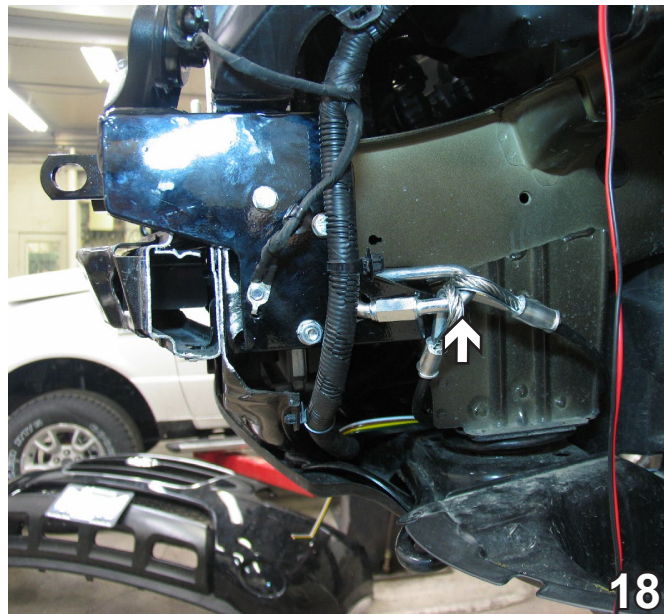

18. Attach the permanent baseplate safety cables to the provided convenience link on the baseplate. The photo above shows the recommended installation of the cables to frame of vehicle. Additional options may interfere with suggested mounting; in this case secure the cables to a solid piece of the frame as described in the instructions included with the permanent baseplate safety cables. Be sure the safety cables do not rub against any hoses or moving parts. Do this to both sides of the vehicle

BX2324

2007-09 Hyundai Santa Fe

Installation Instructions

Install the tow bar and safety cables according to the instructions provided in their packages. When demonstrating this to the customer, be sure to include all the contents and packages.

Do **NOT** substitute other devices if the tow bar pins and clips are misplaced.



Shown without removable tabs installed.



Shown with removable tabs installed.

If the baseplate is in an accident, it must be replaced. **DO NOT** use it again! An accident can cause unseen damage and using it again could result in more damage or serious injury. **DO NOT** use the baseplate if it is damaged or missing parts.

DEALER or INSTALLER:
Be certain the user receives the instruction sheets for their products.

CUSTOMER SERVICE COMMITMENT

Blue Ox is committed to providing you with exceptional customer care throughout your lifetime with our products. Our team is here to assist you with any questions you may have regarding the performance of your product. Simply call (402) 385-3051 and you can speak with our customer care team.

Additionally, please visit our website to see which rallies our Destination America team will be attending. For a nominal fee, our service technician will service your towing system to ensure it's in proper working condition. Also as a commitment to our customers, should you visit our factory you can stay at our full service Blue Ox campground at no charge along with enjoying a factory tour.

Again thank you for being our customer and for the confidence you have shown in the performance of our products. It is because of customers like you we enjoy the success we have today.



© 2007, 09, 10 Blue Ox
One Mill Road, Industrial Park
Pender, Nebraska 68047
Phone: (402) 385-3051 • Fax: (402) 385-3360
www.blueox.com

General Information

1. Ensure that your product(s) are registered online at www.blueox.com. It is crucial to register your product(s) so that you may be alerted of product offerings, updates, upgrades, maintenance and safety bulletins, and/or recalls.
2. **It is the owner's responsibility to inspect all towing equipment for cracked welds, missing or worn parts and loose bolts before each towing trip.** Be sure to use Loctite® Red on all bolts and tighten to the recommended specifications.
3. **It is the owner's responsibility to hook up all towing equipment per manufacturer's instructions/recommendations.**
4. Remove the attachment tabs when not in use (if applicable).

Notice To Baseplate Installer

1. **It is YOUR responsibility to watch for:**

- Oil cooler and air conditioner lines
- Electrical wires and hoses
- Missing parts or attaching points on the frame

** If the baseplate is improperly installed and is against a wire or hose, it could cause fluid leaks or electrical shorts some time after the actual baseplate installation.

Permanent Baseplate Safety Cable Installation

Permanent baseplate safety cables are strongly recommended when towing a vehicle with a tow bar. The principle function of the permanent baseplate safety cables is to prevent the towed vehicle from breaking loose in the event the connection between the frame of the towed vehicle and the baseplate fails or becomes disconnected. The cables must be connected from the baseplate to the frame rail or cross member of the vehicle's frame. The illustrations below show the possible arrangements recommended by Blue Ox®. Each permanent baseplate safety cable must have an adequate weight rating for the towing system. The weight rating of the two (2) cables together will not qualify.

Do not mount the permanent baseplate safety cables against wires, hoses or brake lines.

These permanent baseplate safety cables should remain installed as long as the baseplate is installed on the vehicle. Permanent baseplate safety cables are to be used in conjunction with, and NOT a replacement for legally required safety cables attaching the towed vehicle to the towing vehicle.

OPTION #1

Permanent Baseplate Safety Cables to Cross Member or Frame of Towed Vehicle.

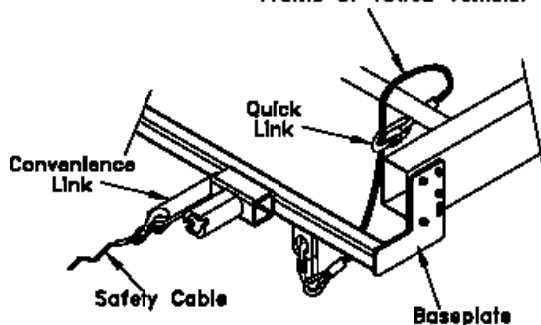

OPTION #2

Permanent Baseplate Safety Cables to Cross Member or Frame of Towed Vehicle.

